

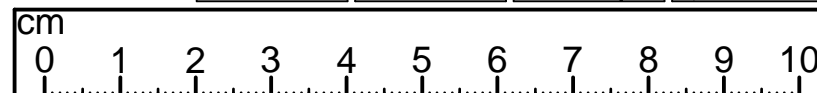

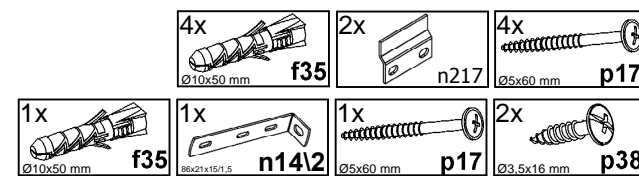

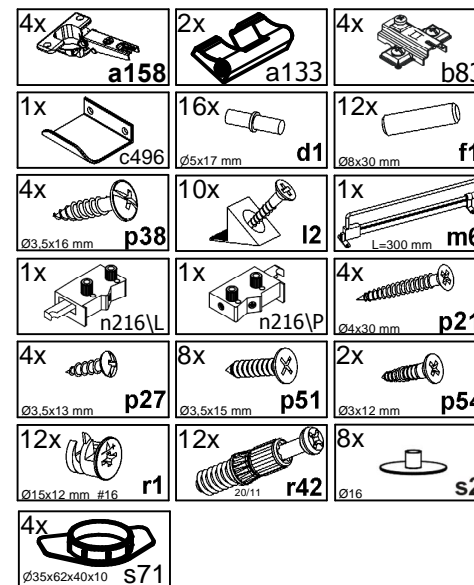







A	B	C1	C2	C3	D
1	M245-0001	1776	546	16	2/2
2	M245-1001	1772	347	16	1/2
3	M245-1002	1772	347	16	1/2
4	M245-2001	550	370	16	1/2
5	M245-3001	517	347	16	1/2
6	M245-3002	517	327	16	1/2
7	M245-3003	516	327	16	1/2
8	M245-9001	1766,	527	2,5	2/2

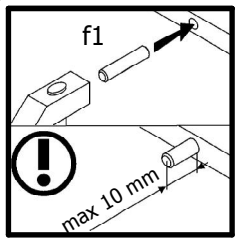
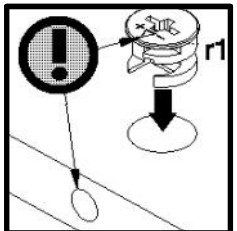
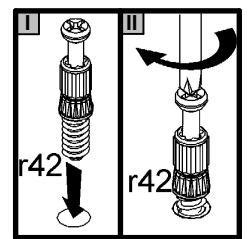
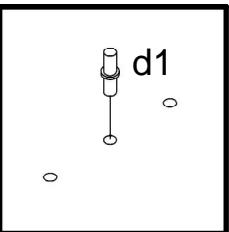
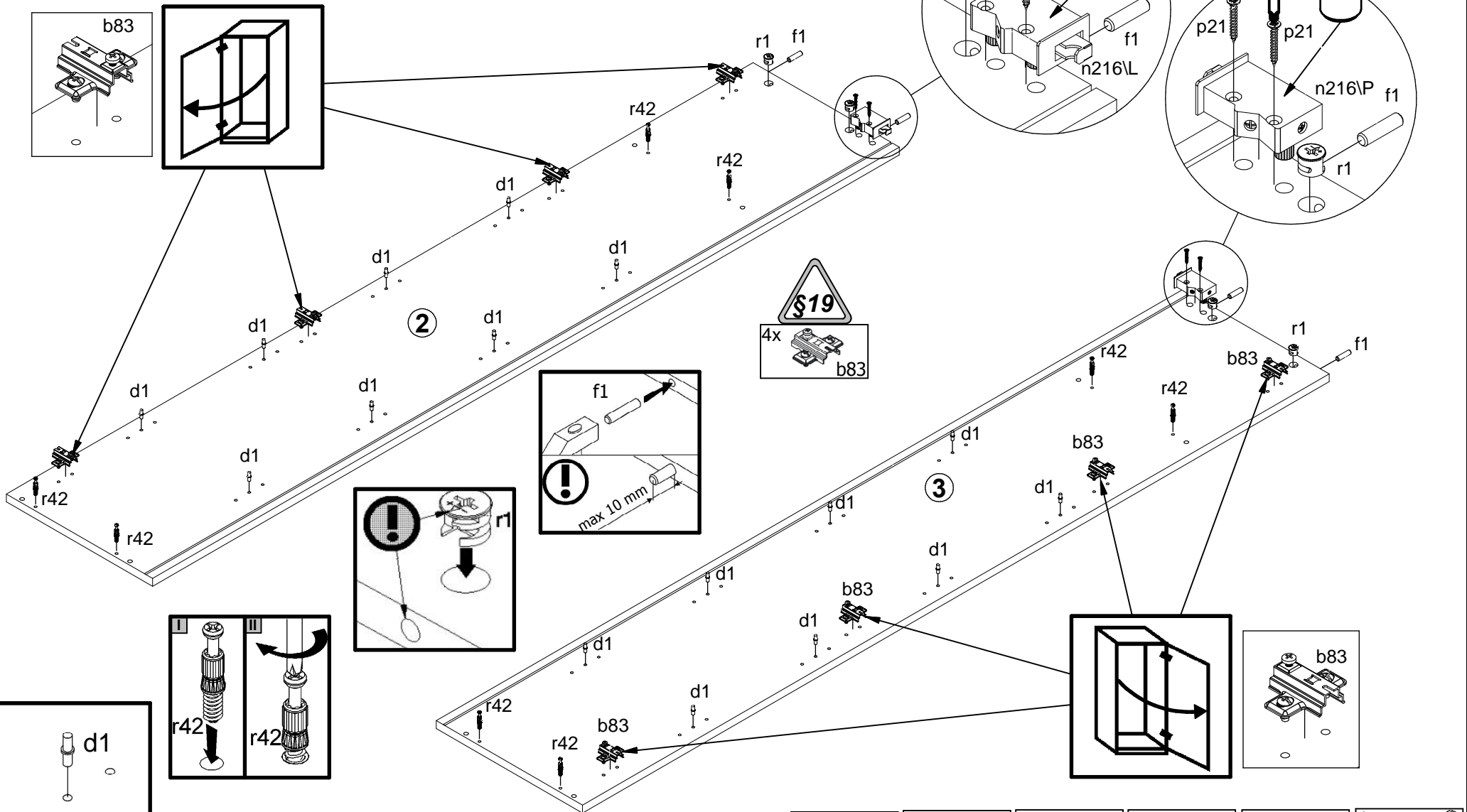

- 8x  d1 ∅5x17 mm
- 2x  r1 ∅15x12 mm #16
- 2x  f1 ∅8x30 mm
- 4x  r42 20/11
- 1x  n216L
- 2x  p21 ∅4x30 mm



- 2x  p21 ∅4x30 mm
- 1x  n216P
- 8x  d1 ∅5x17 mm
- 2x  r1 ∅15x12 mm #16
- 2x  f1 ∅8x30 mm
- 4x  r42 20/11

1

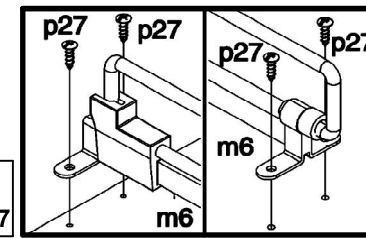
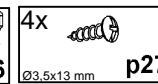
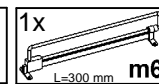
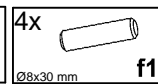
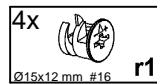
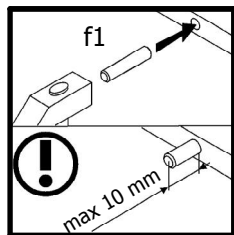
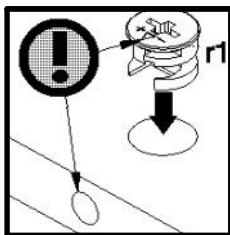
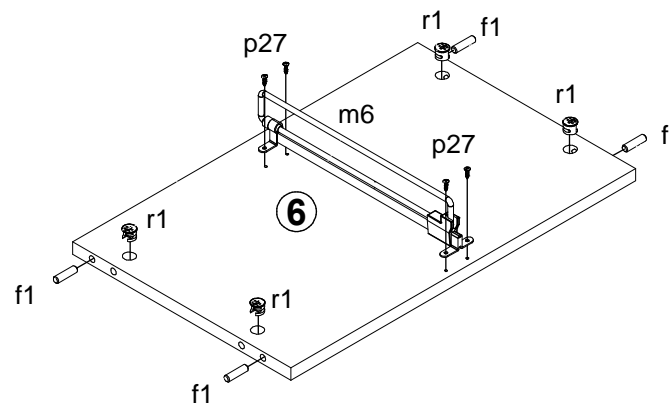
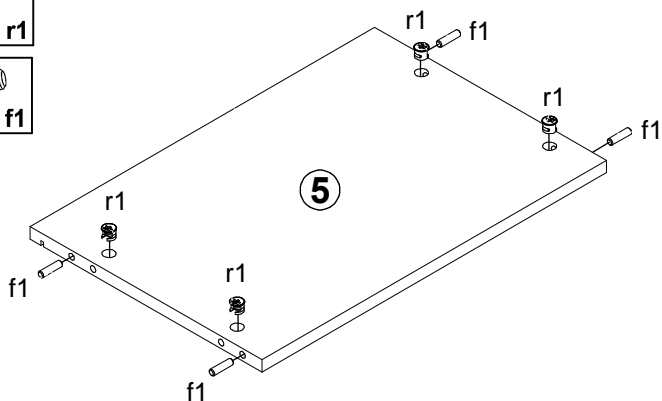
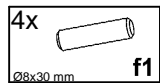
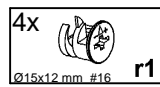
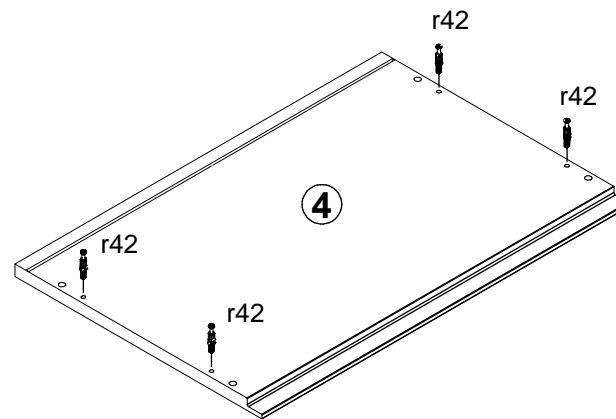
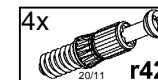
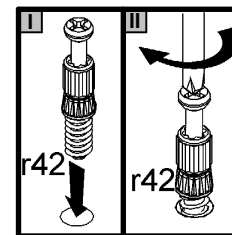

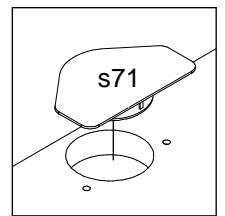
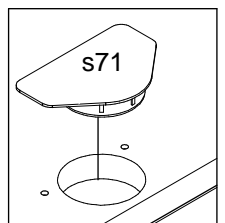
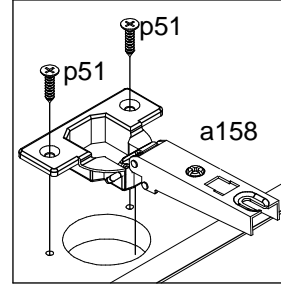
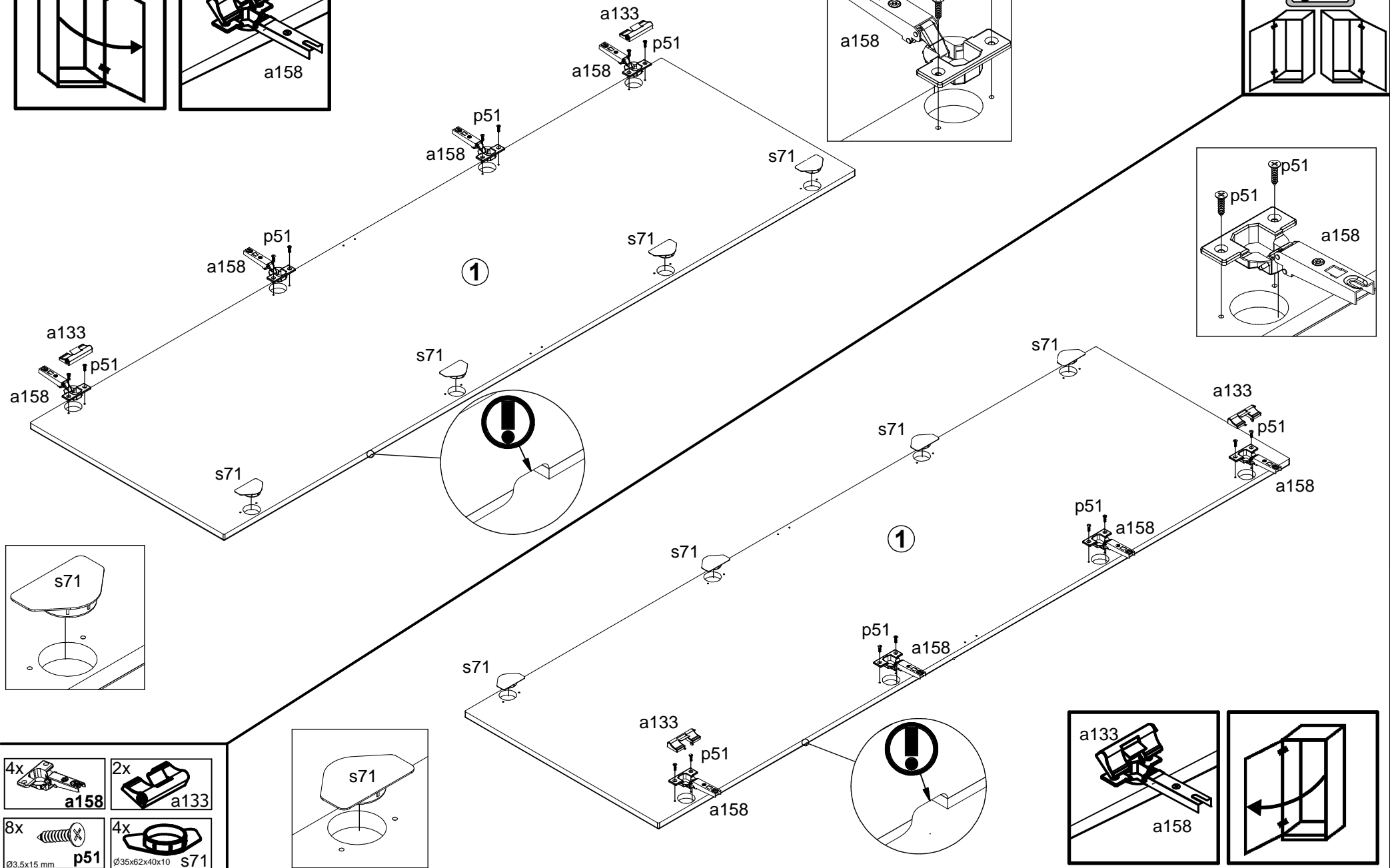
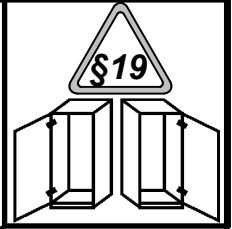
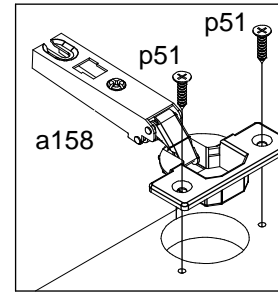
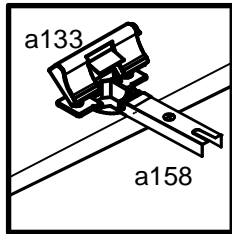
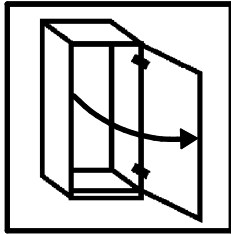

- 4x a158
- 2x a133
- 8x p51 Ø3.5x15 mm
- 4x s71 Ø35x62x40x10

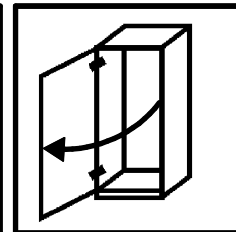
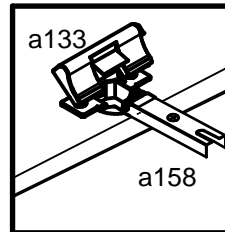

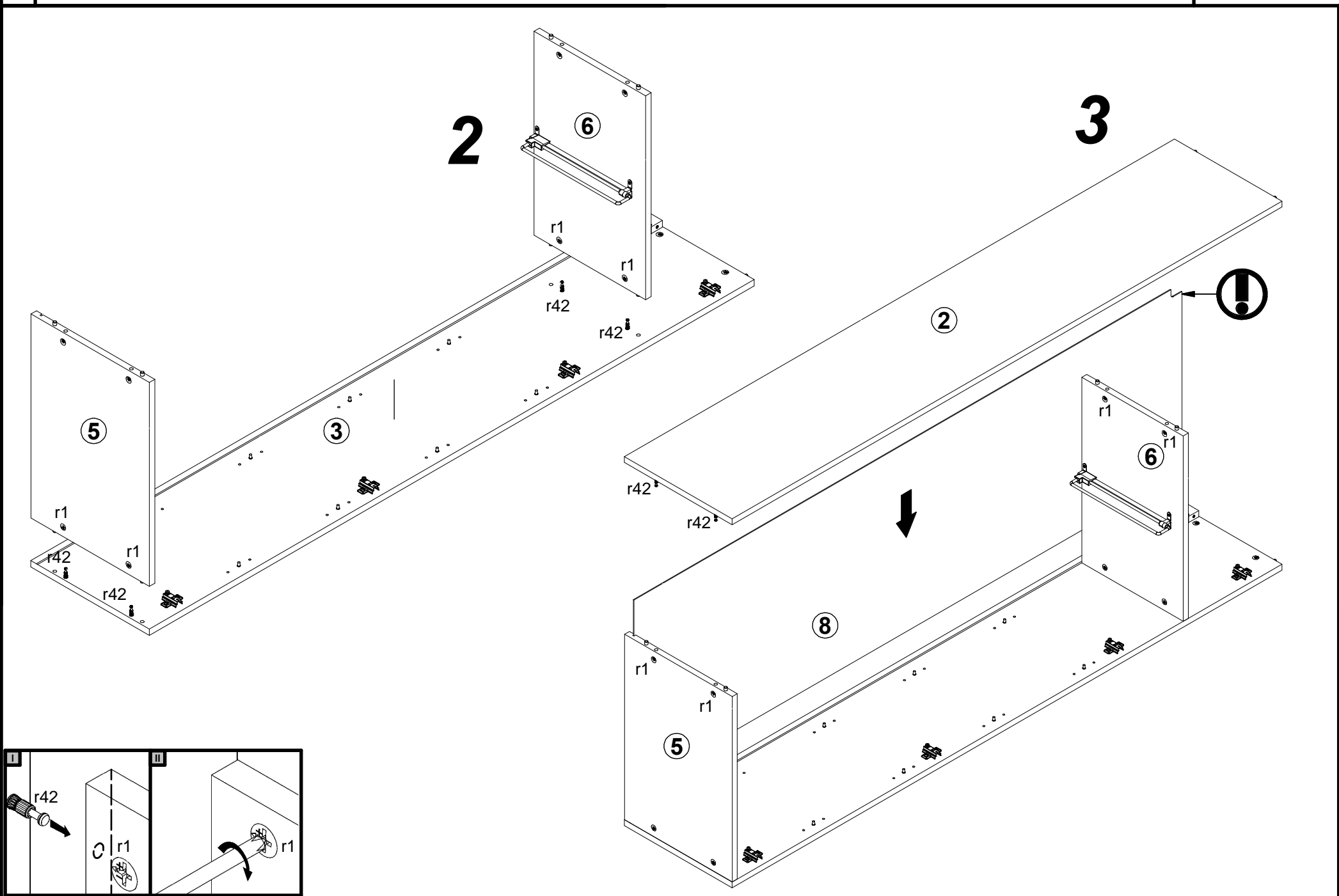

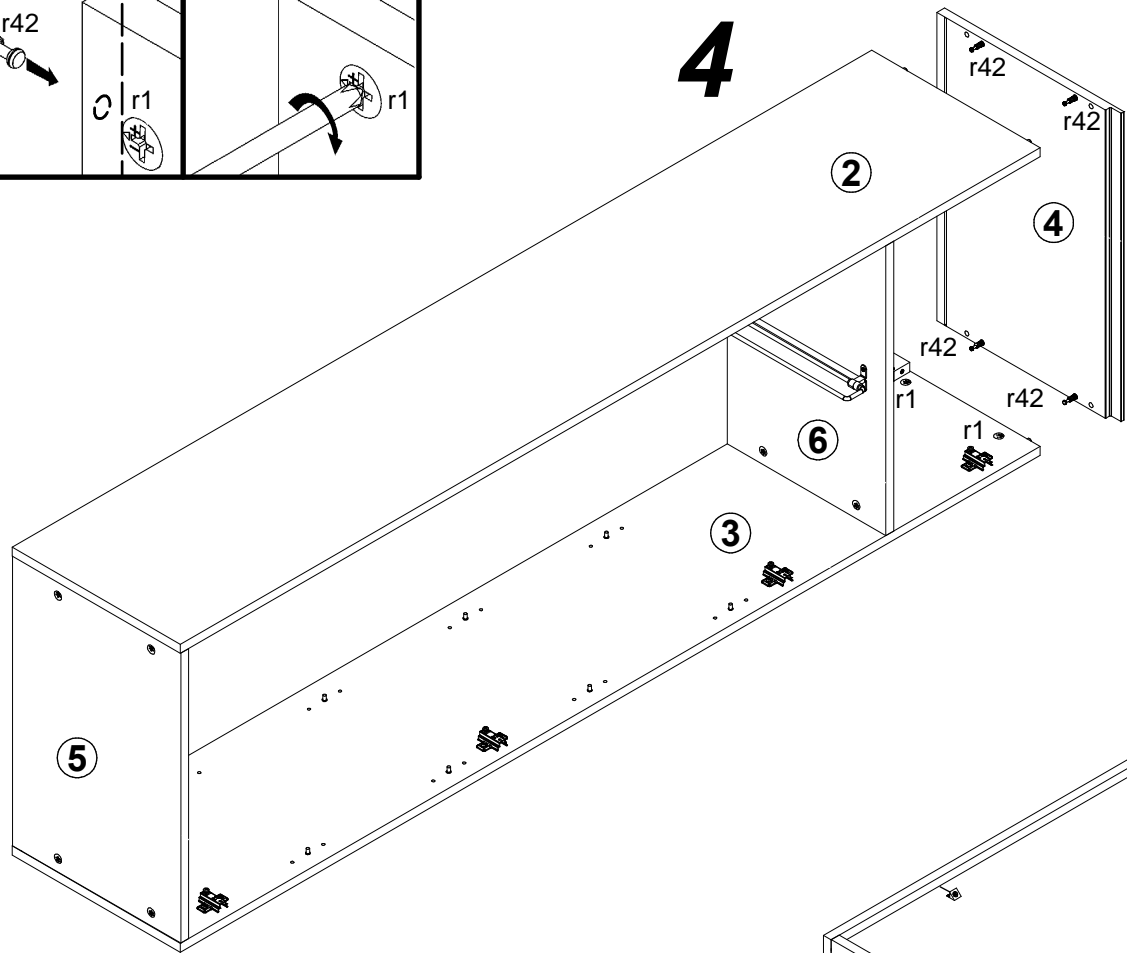
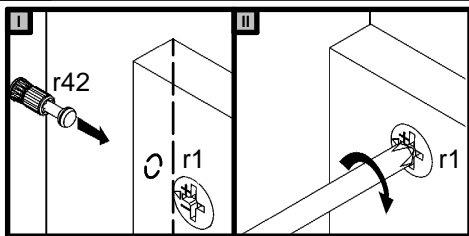

5

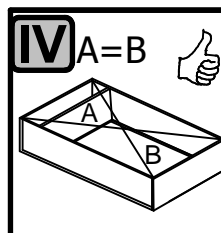
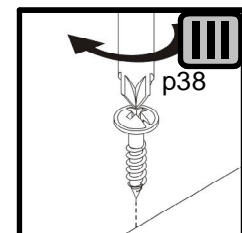
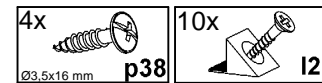
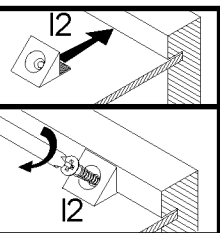
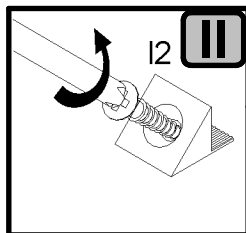
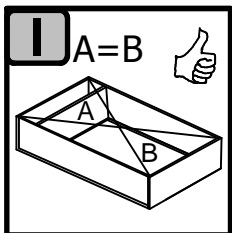

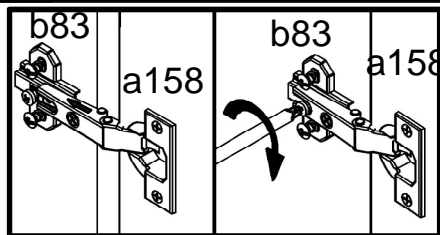

6

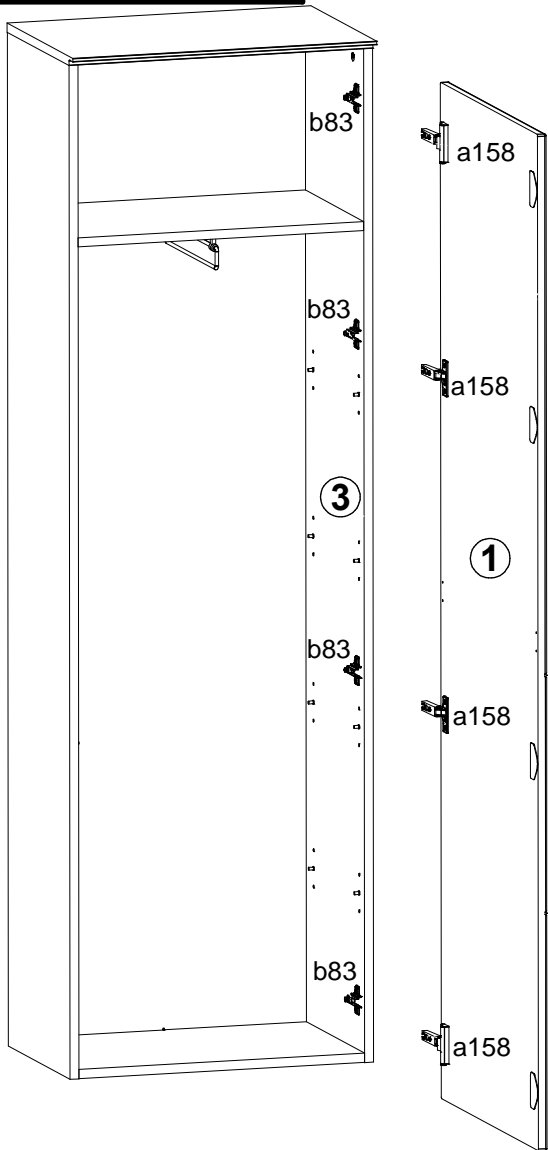

7

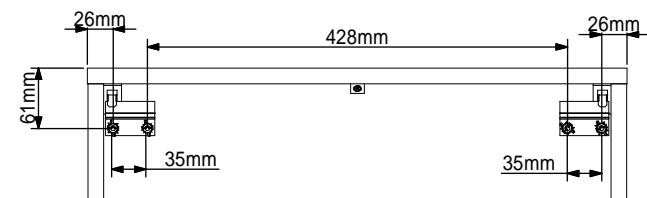
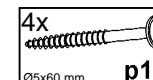
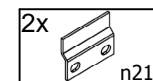
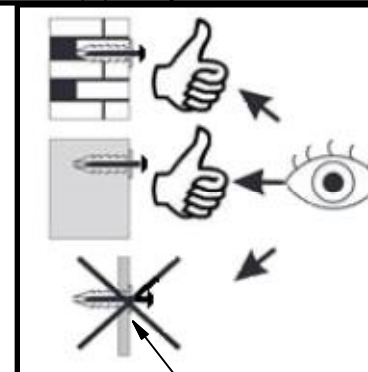
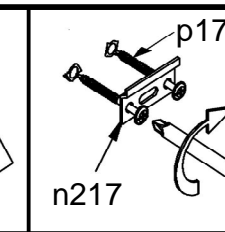
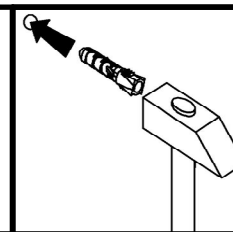
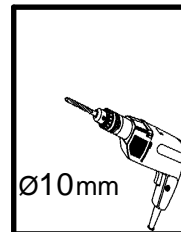
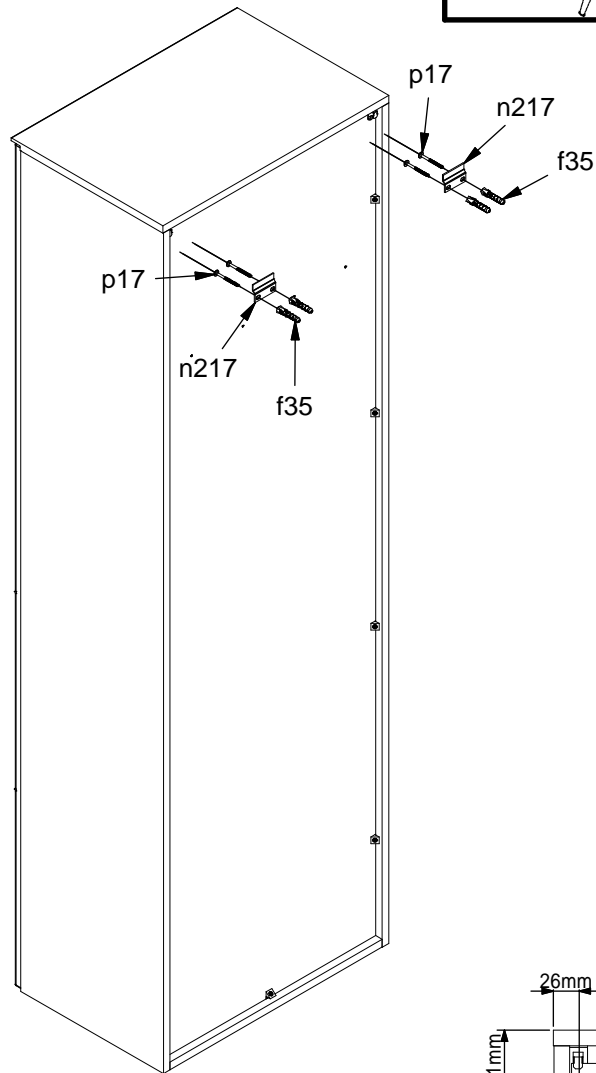

A

M245-SFW1D/18/6

30 B9 99 01,05

9 / 9

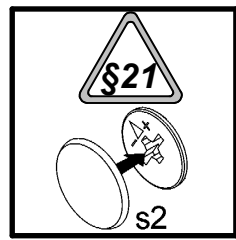
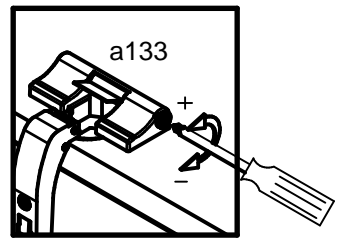
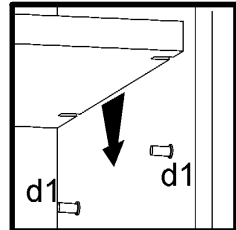
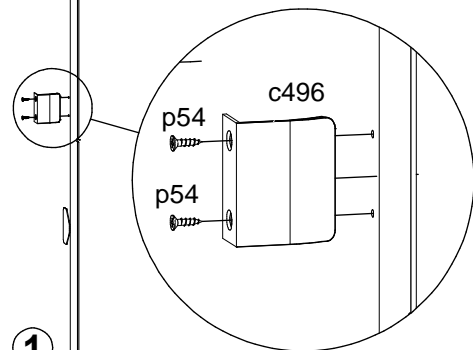
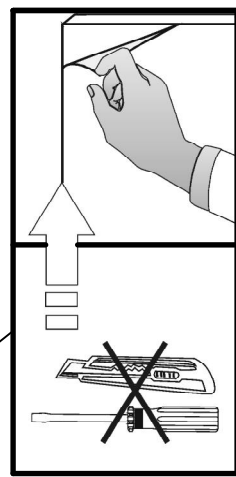
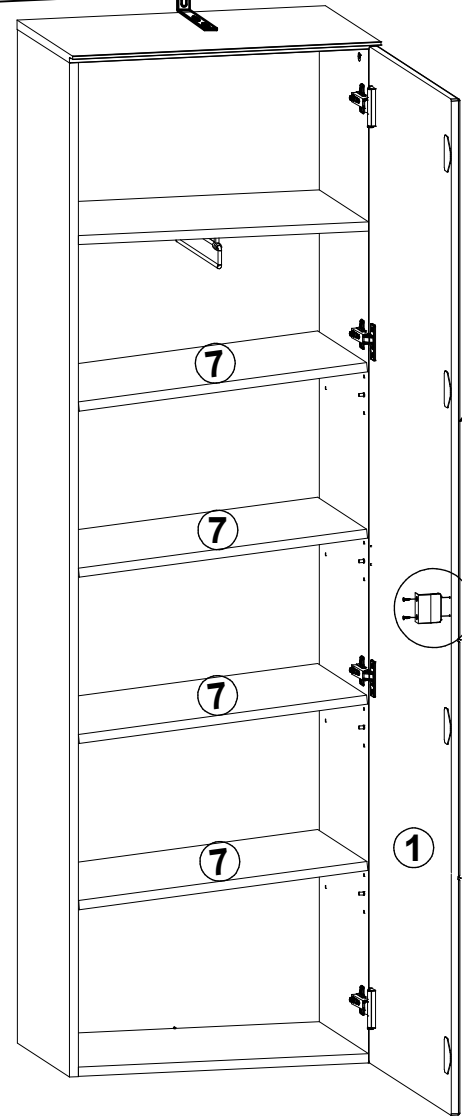
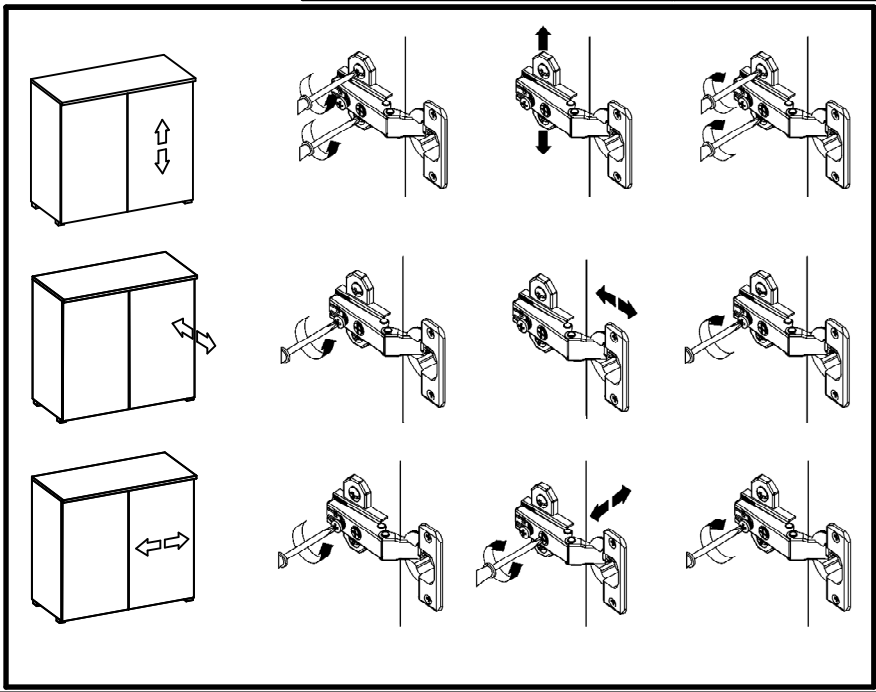
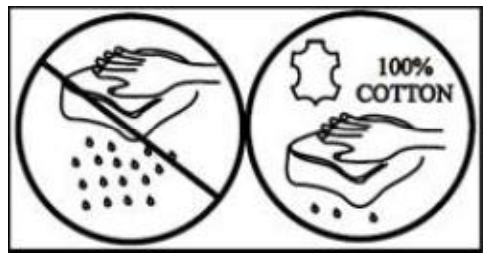
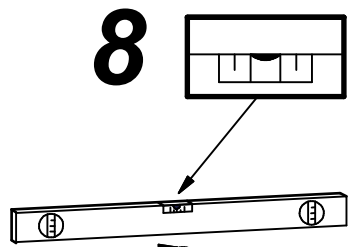
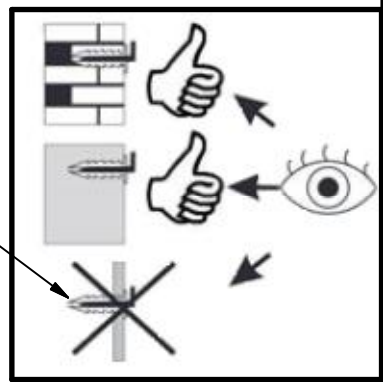
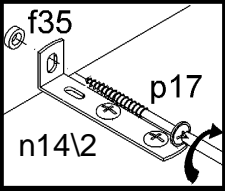
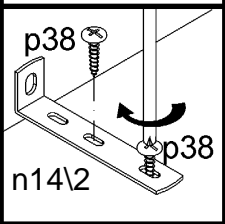
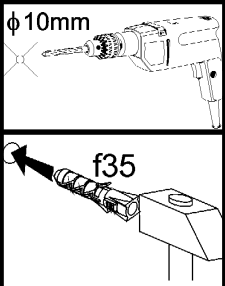
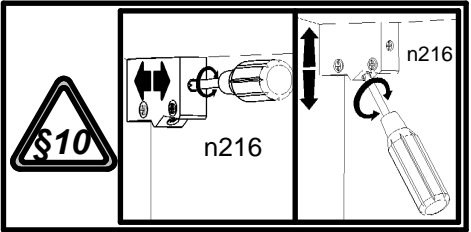

- 2x p38
Ø3.5x16 mm
- 1x f35
Ø10x50 mm
- 1x n142
86x21x15/1.5
- 1x p17
Ø5x60 mm
- 8x s2
Ø16
- 2x p54
Ø3x12 mm
- 1x c496