

info@inno-mvg.de

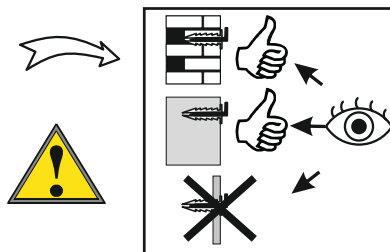

LE TRI + FACILE

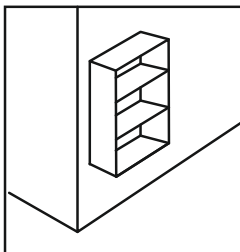
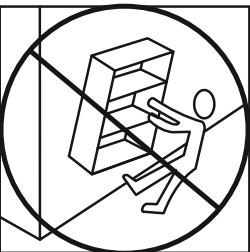

FR

Donnez ou recyclez vos meubles.

Association ou Magasin ou Déchèterie

<https://quefairedemesdechets.fr>

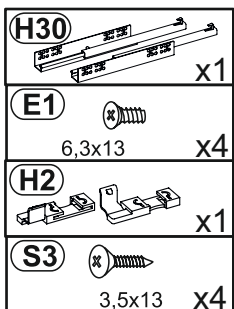
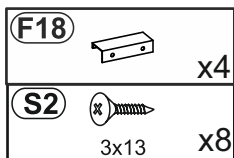
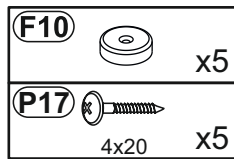
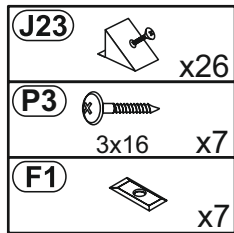
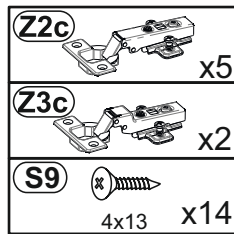
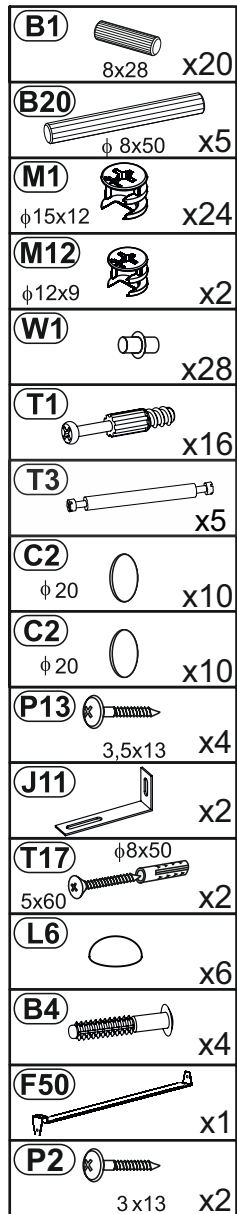

Nr	↙	↖	↗	pcs	
1	964	352	16	1	3
2	964	352	16	1	3
3	964	331	16	1	3
4	1332	374	22	1	2
5	1332	374	22	1	2
6	956	252	16	1	3
7	956	188	16	1	3
8	764	440	16	1	1
9	764	440	16	1	1
10	884	188	16	1	1
11	300	120	12	1	1
12	300	120	12	1	1
13	823	120	12	1	1
14	833	298	2	1	1
15	863	322	16	3	2
16	419	322	16	4	1
17	863	136	16	1	1
18	978	876	2	1	3
19	978	434	2	1	3

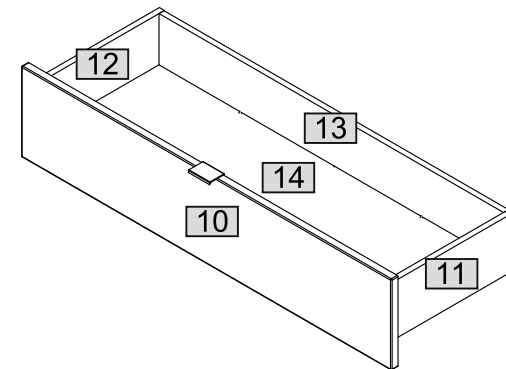
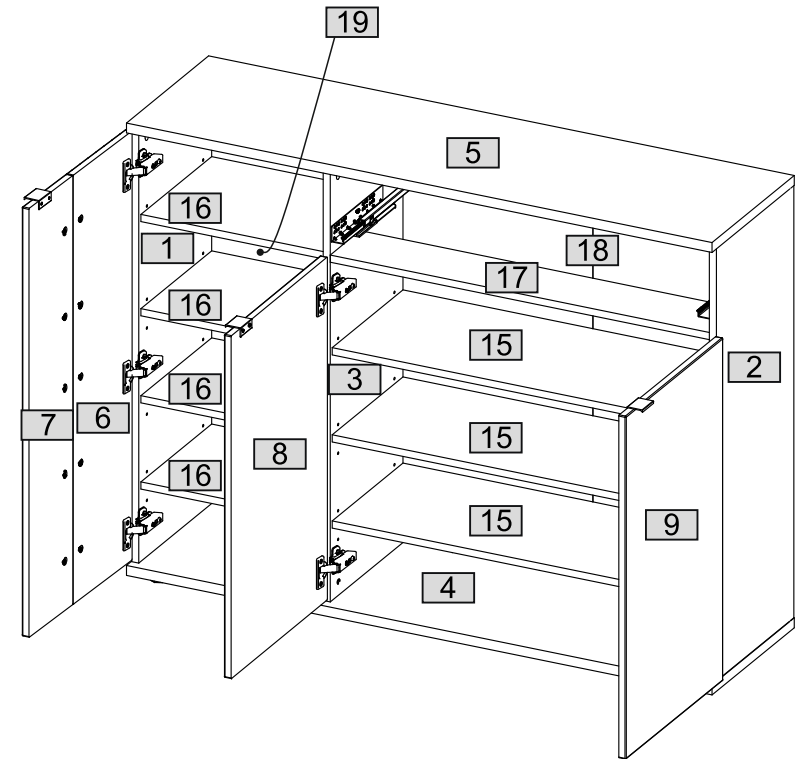

0 10 20 30 40 50 60 70 80 90 100 110 120 130 140 150 160 170 180 190 200



1

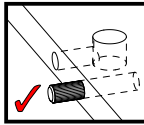
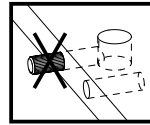
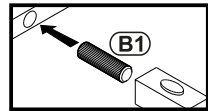
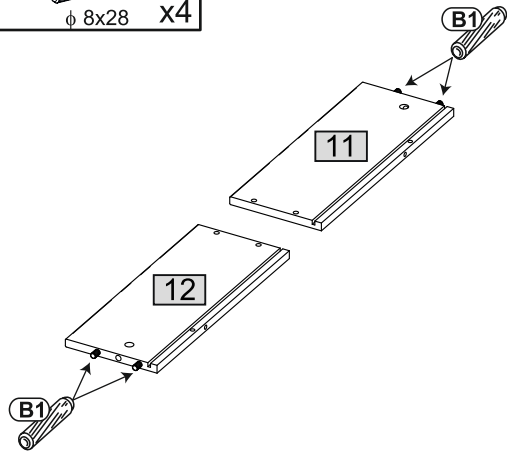
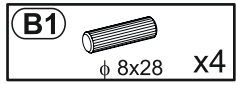

2

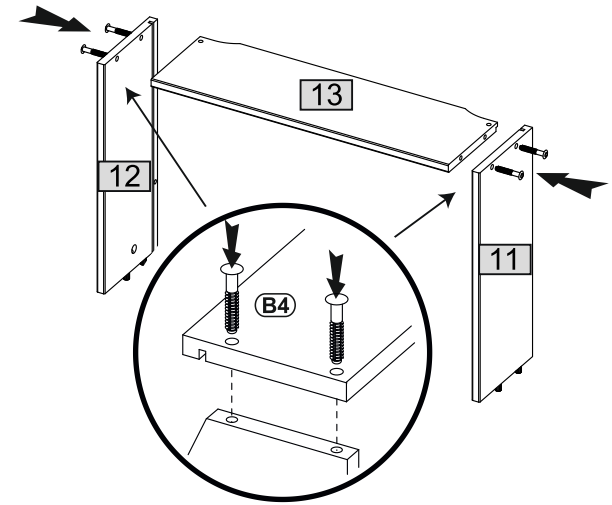
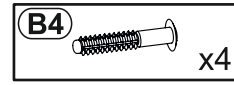

3

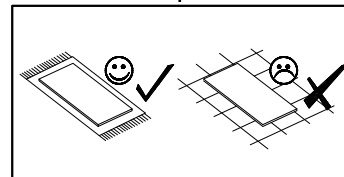
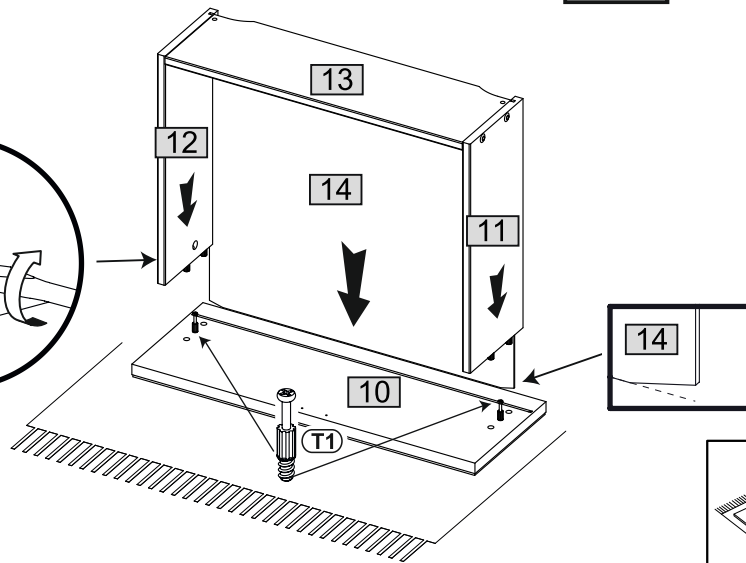
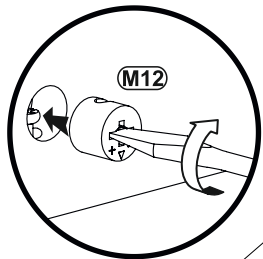
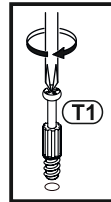
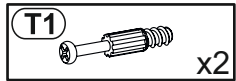

4

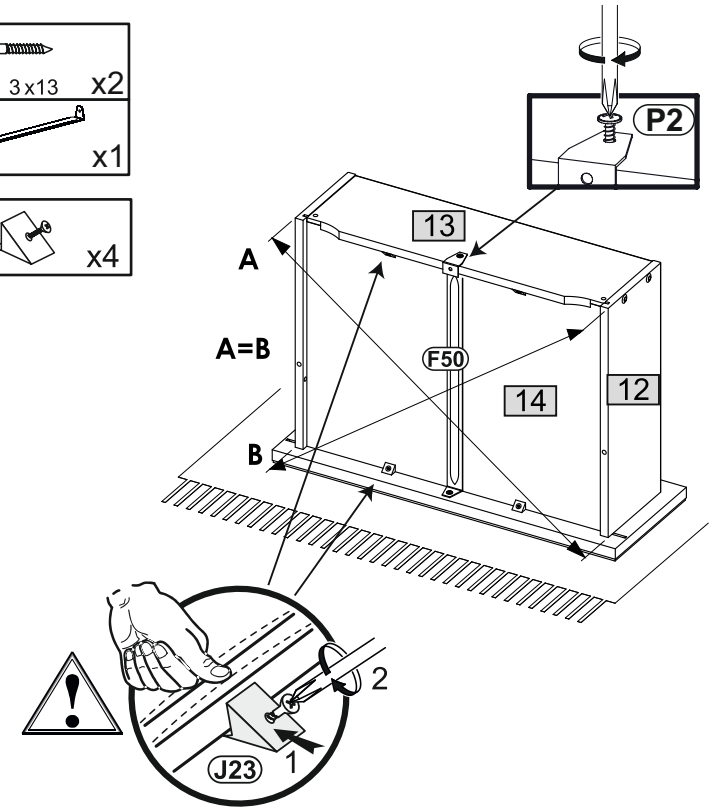
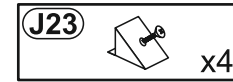
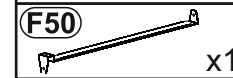
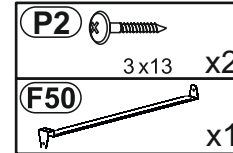

5

- (B1) 8x28 x16
- (T1) x8
- (B20) ϕ 8x50 x5

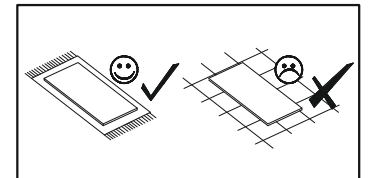
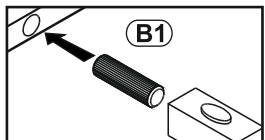
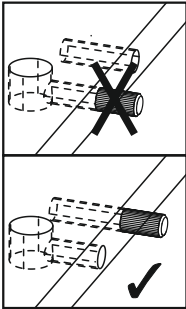
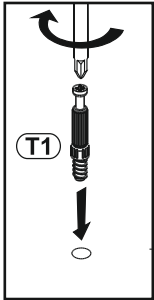
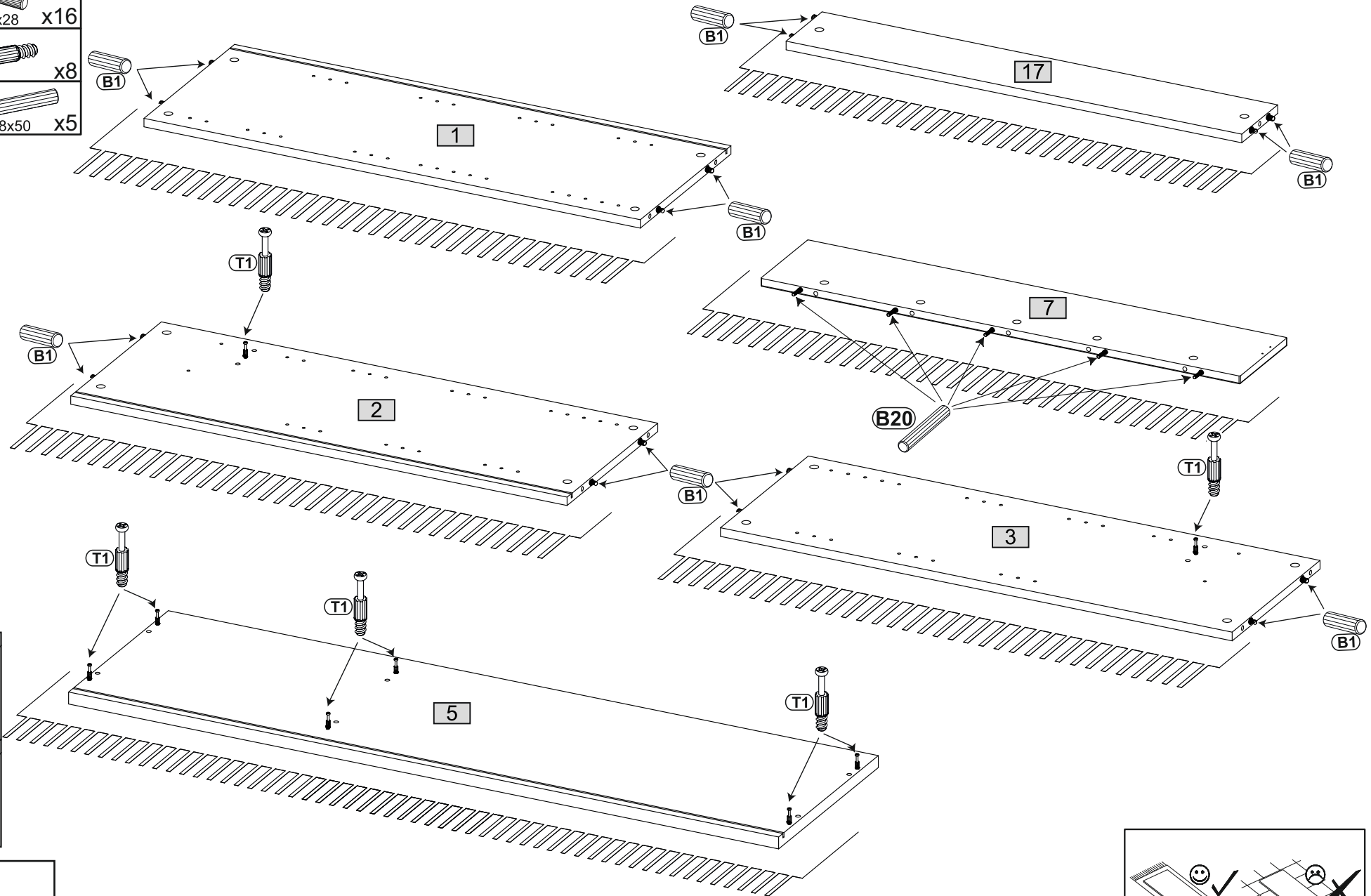

6

- P17** 4x20 x5
- F10** x5

- T1** x6

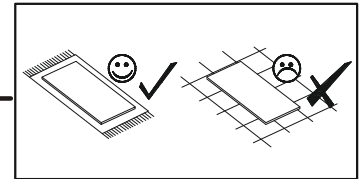
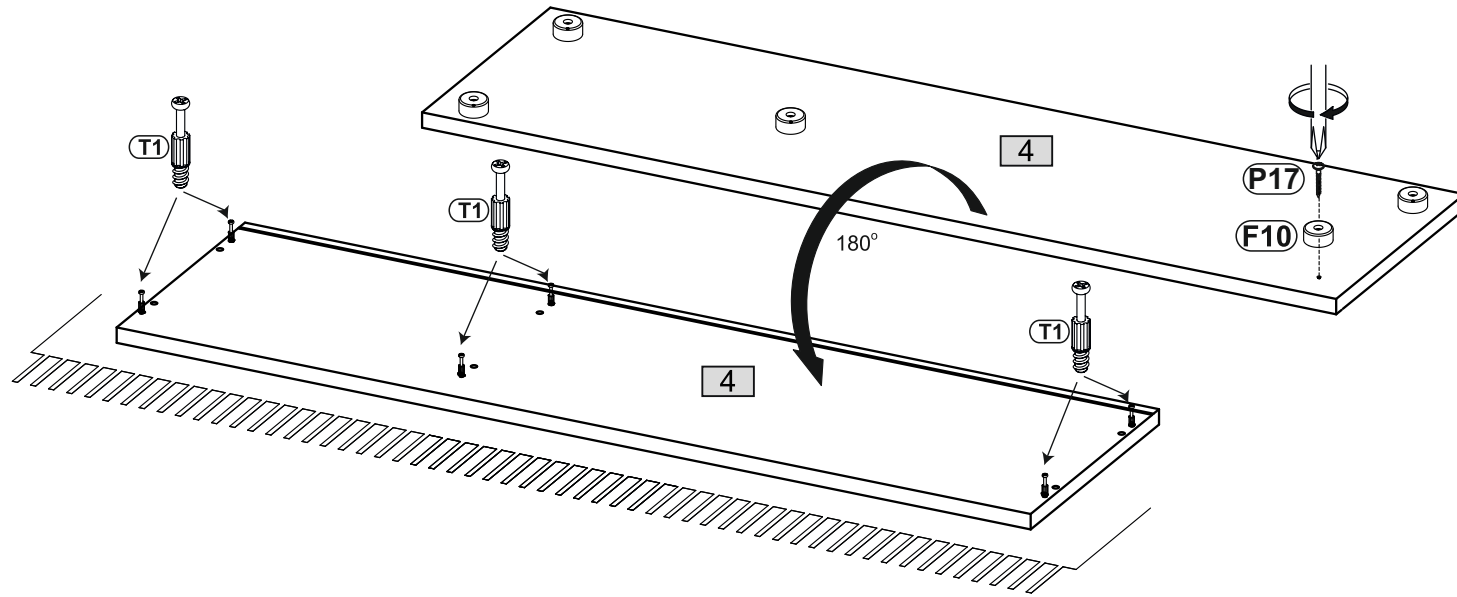

7

- T3** x5
- M1** $\phi 15 \times 12$ x10

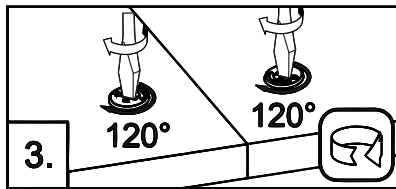
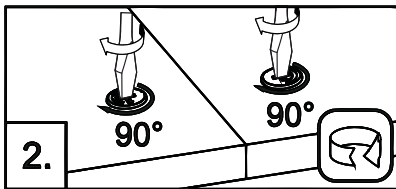
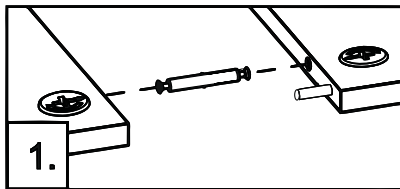
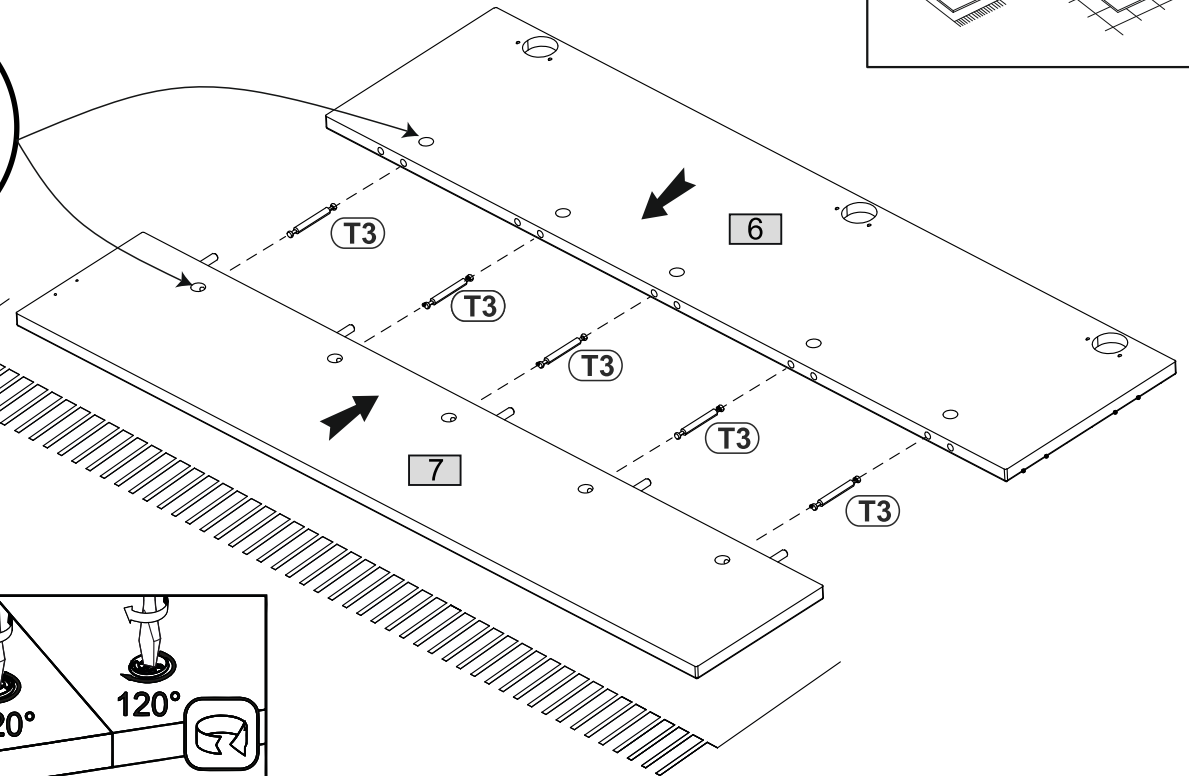
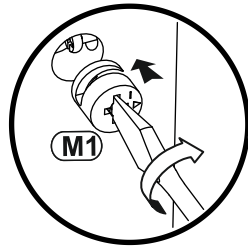

8

- Z2c x5
- Z3c x2
- S9 4x13 x14

- C2 $\phi 20$ x10

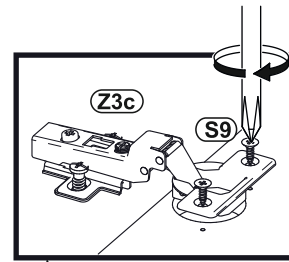
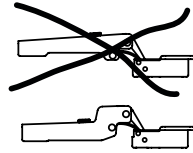
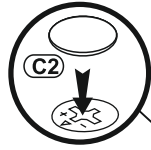

8

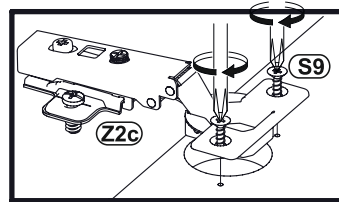
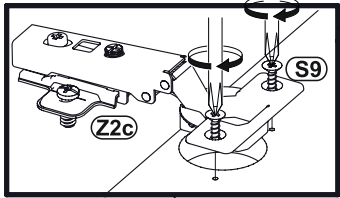
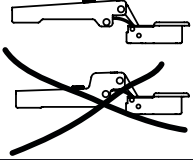

9

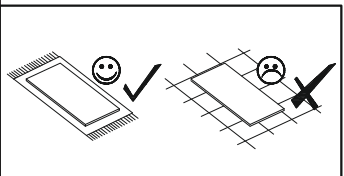
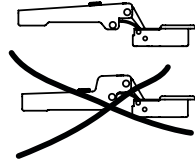

9 **(M1)**  $\phi 15 \times 12$ x2

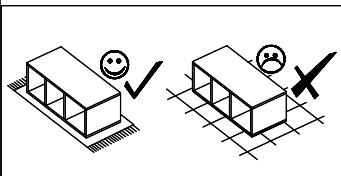
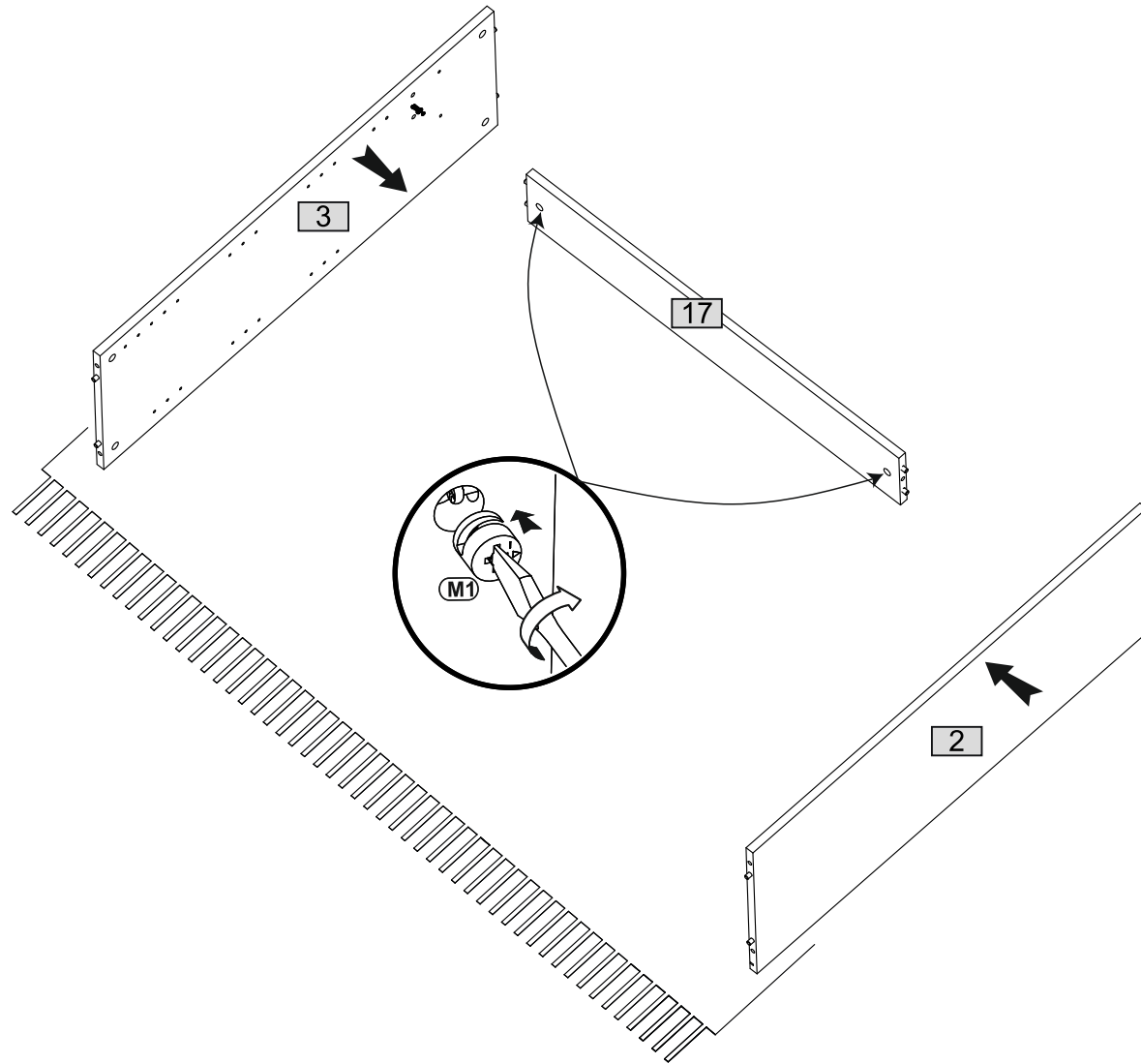

10 **M1**
φ15x12  x6



11 **M1**
φ15x12  x6

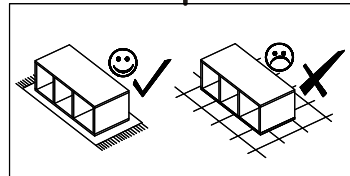
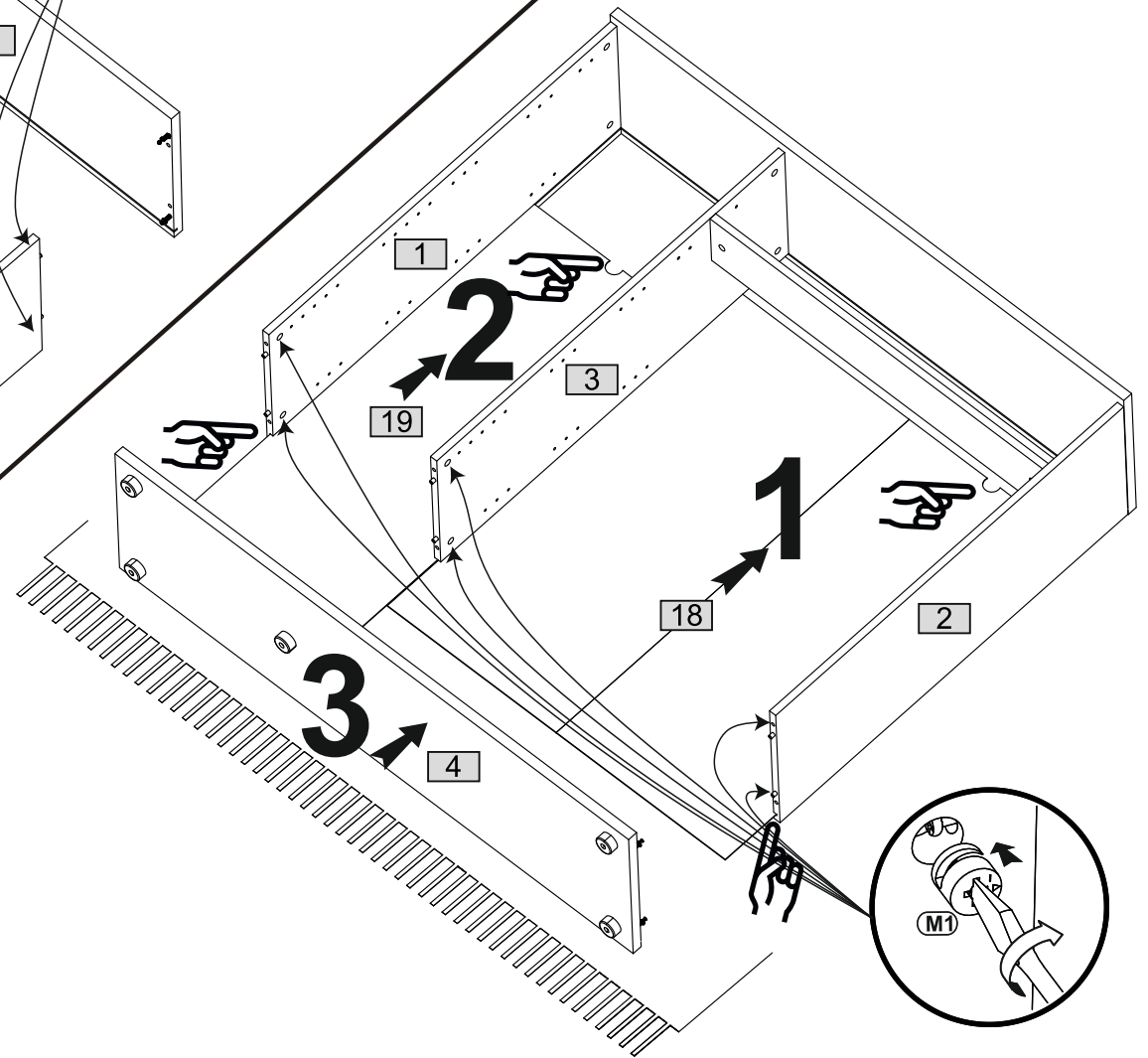
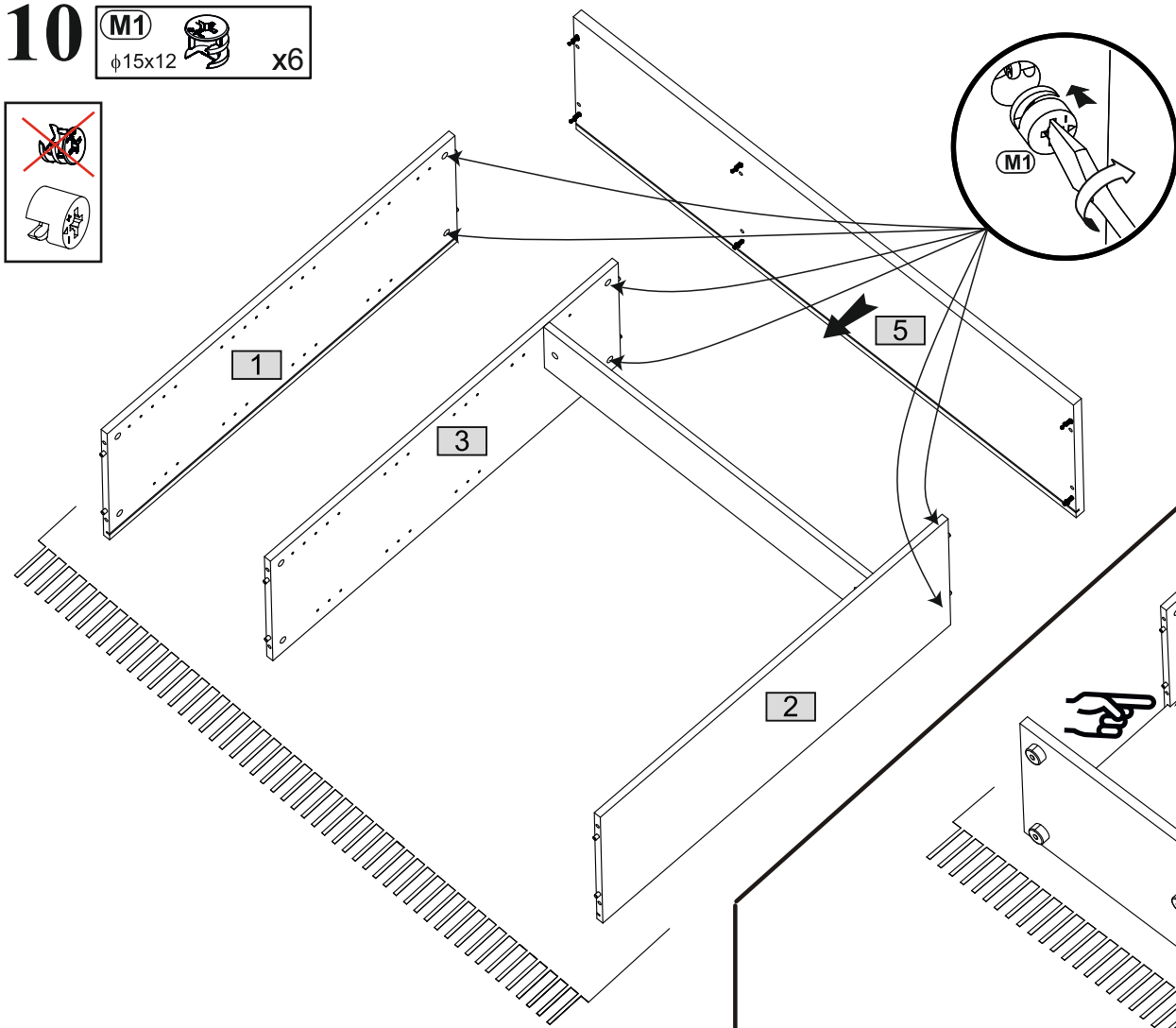

12

J23  x22

P3  3x16 x7

F1  x7

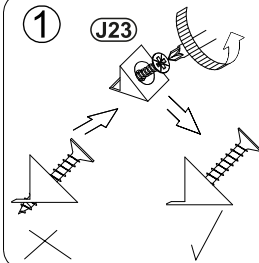
1  **J23**

2  **J23**

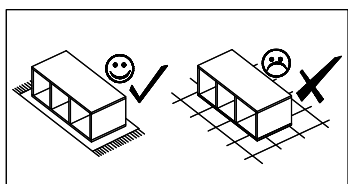
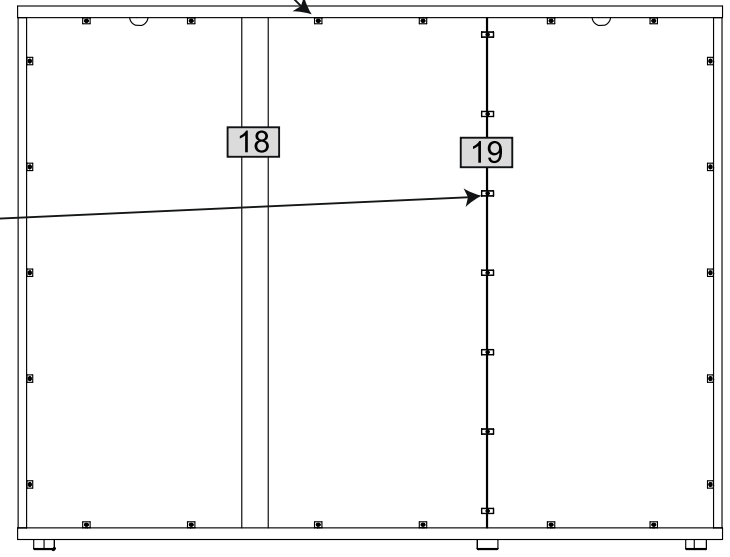
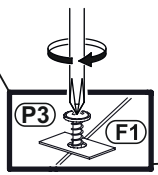
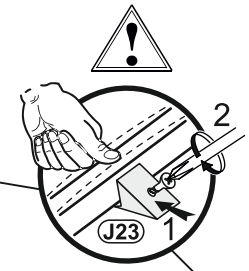
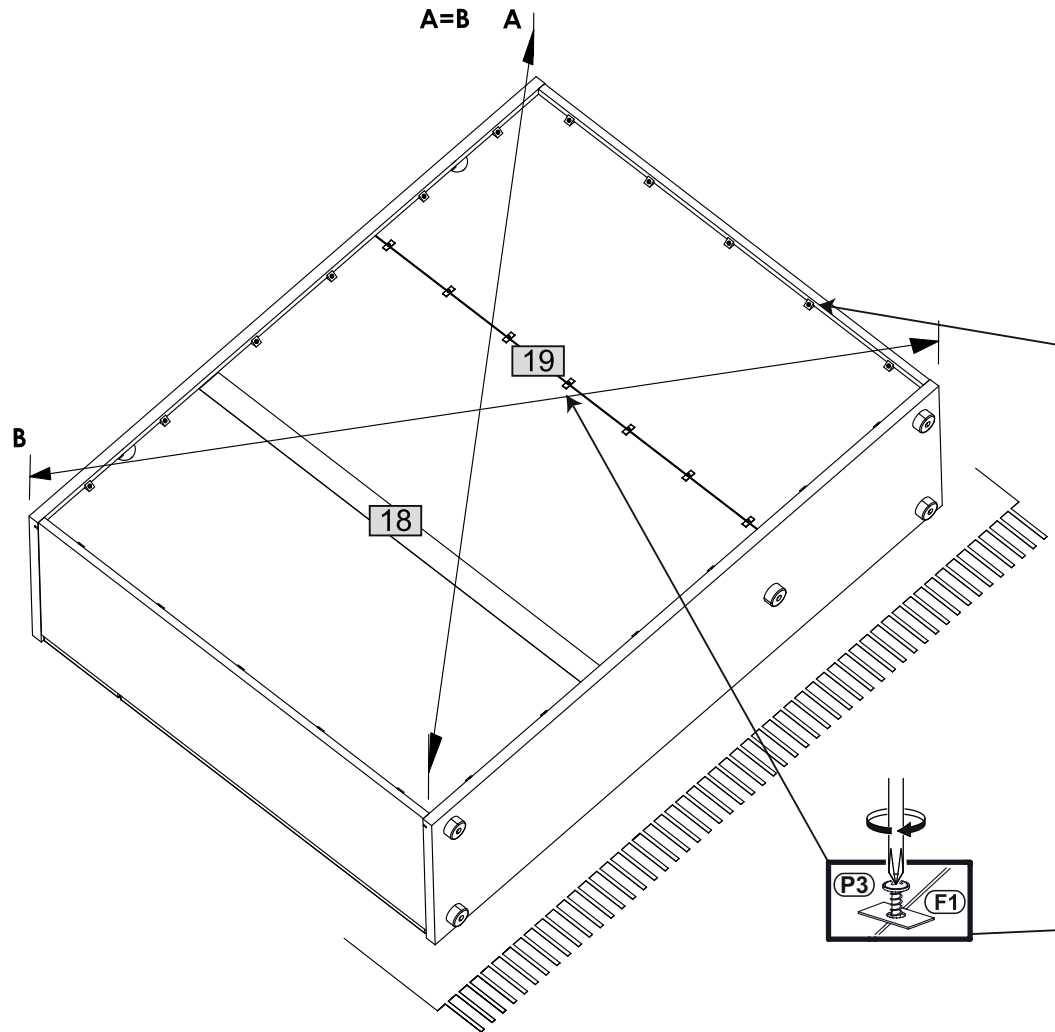

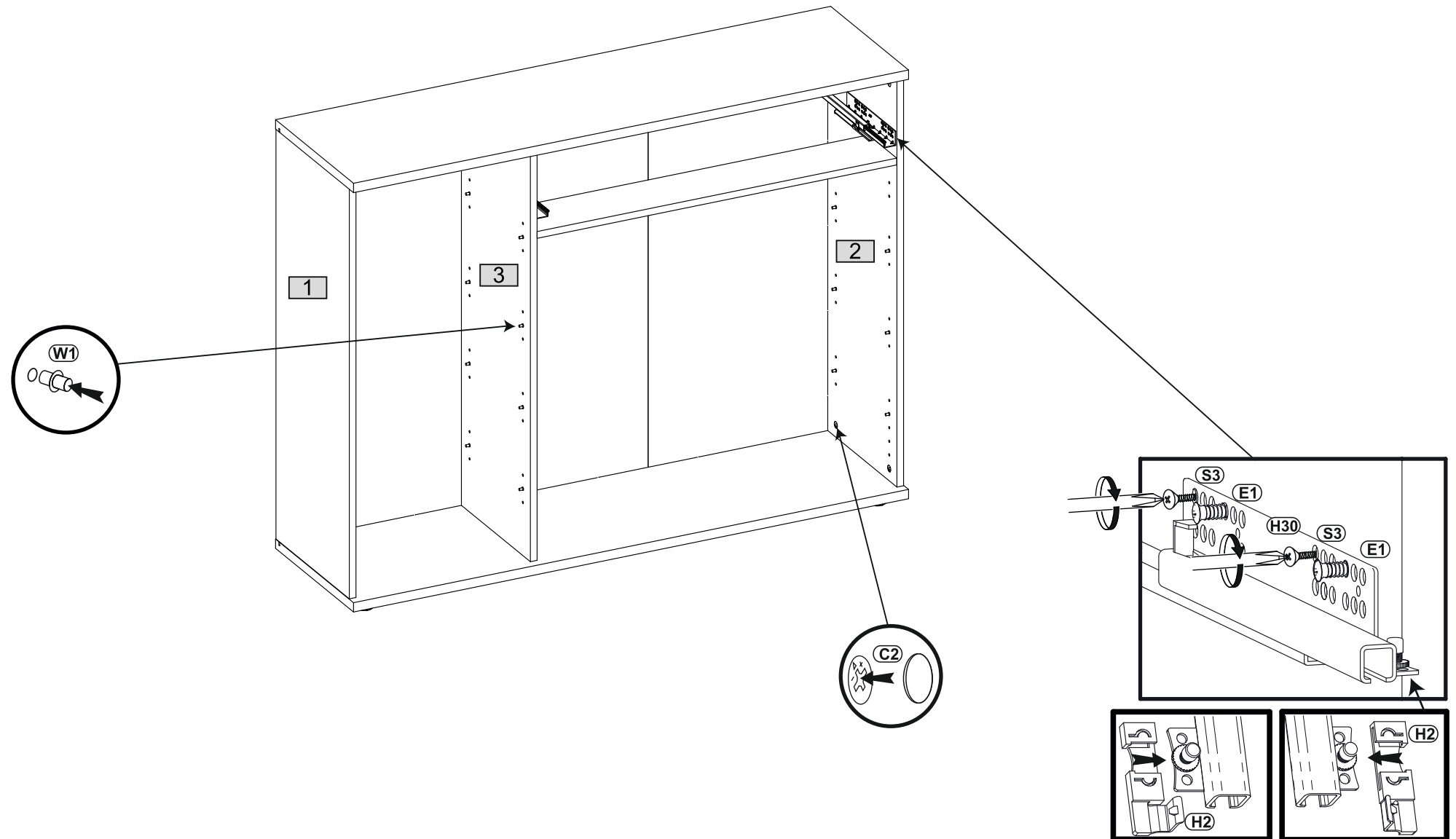
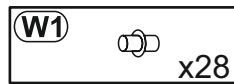
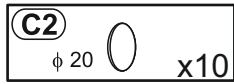
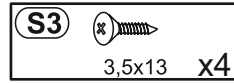
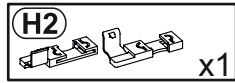
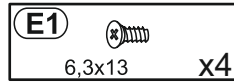
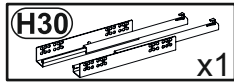

13

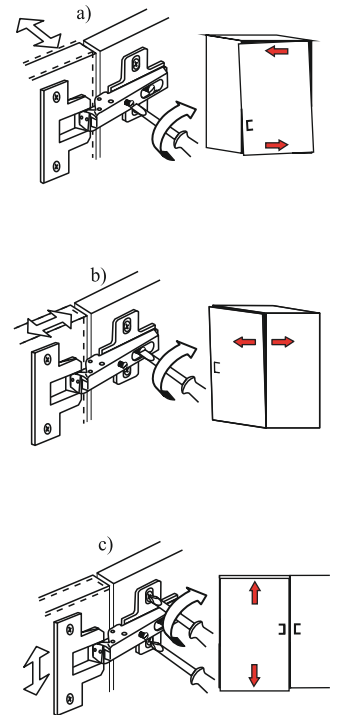
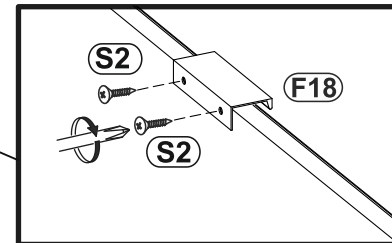
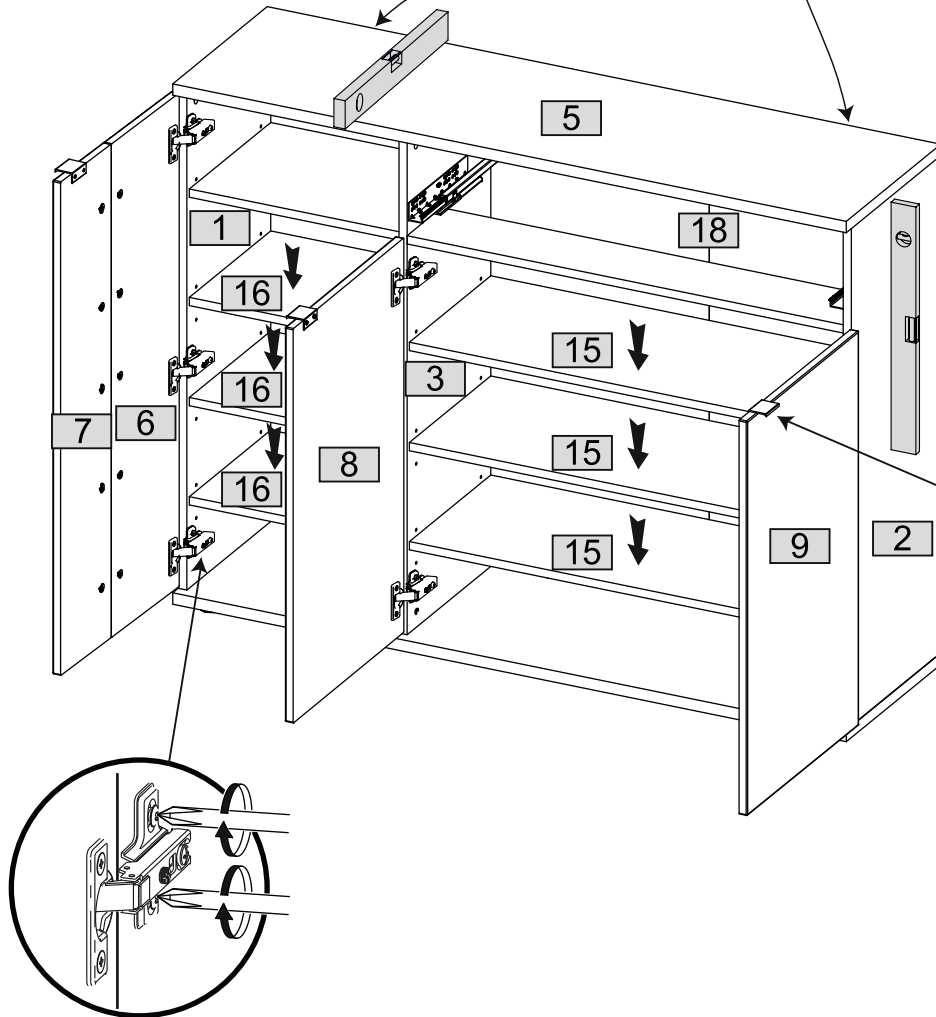
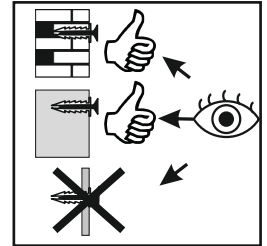
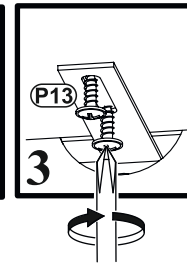
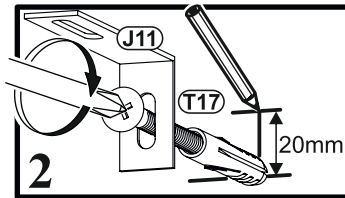
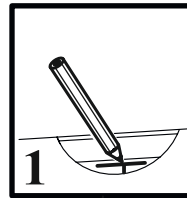
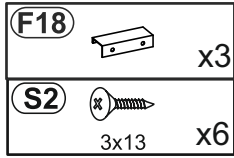
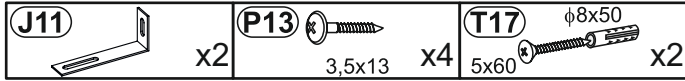

14



15

L6		x6
F18		x1
S2		3x13 x2

