

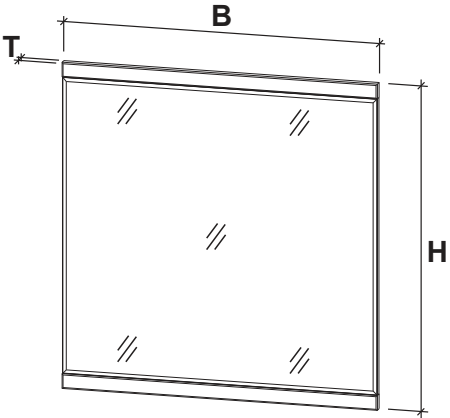

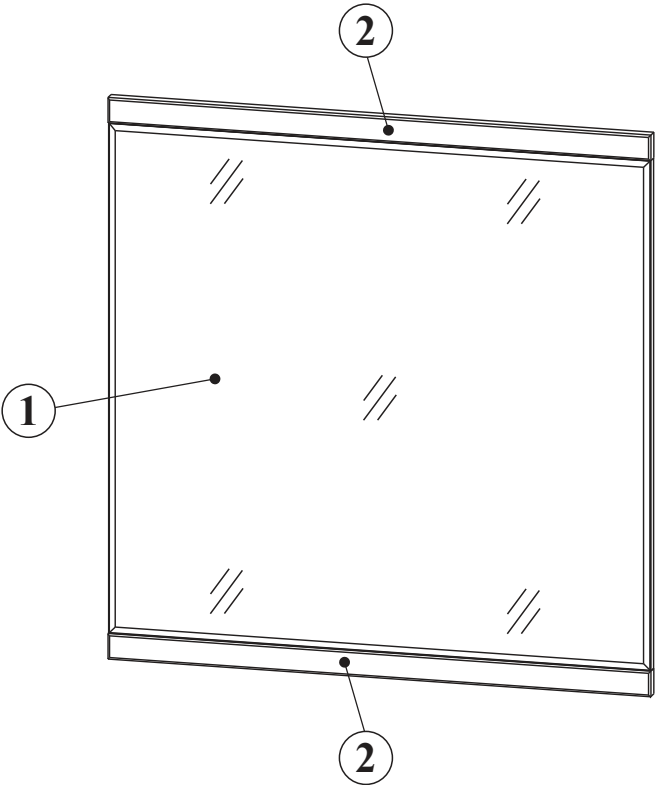



PERSIKO 6A02HH50



B -851mm
 H -880mm
 T -20mm

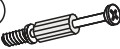

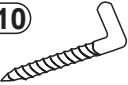
NR1

- B20**  ϕ 8x55 x4
- M1**  ϕ 15x12mm x6
- T1**  5x39mm x6
- C18**  5mm x2
- T10**  x3
- T13**  8x40mm x3

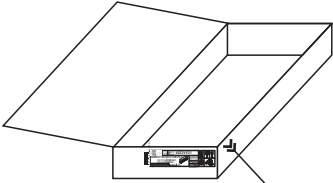

1	850	800	1	1/1
2	851	40	2	1/1

F50  x3

E2  6x9,5 x6

1

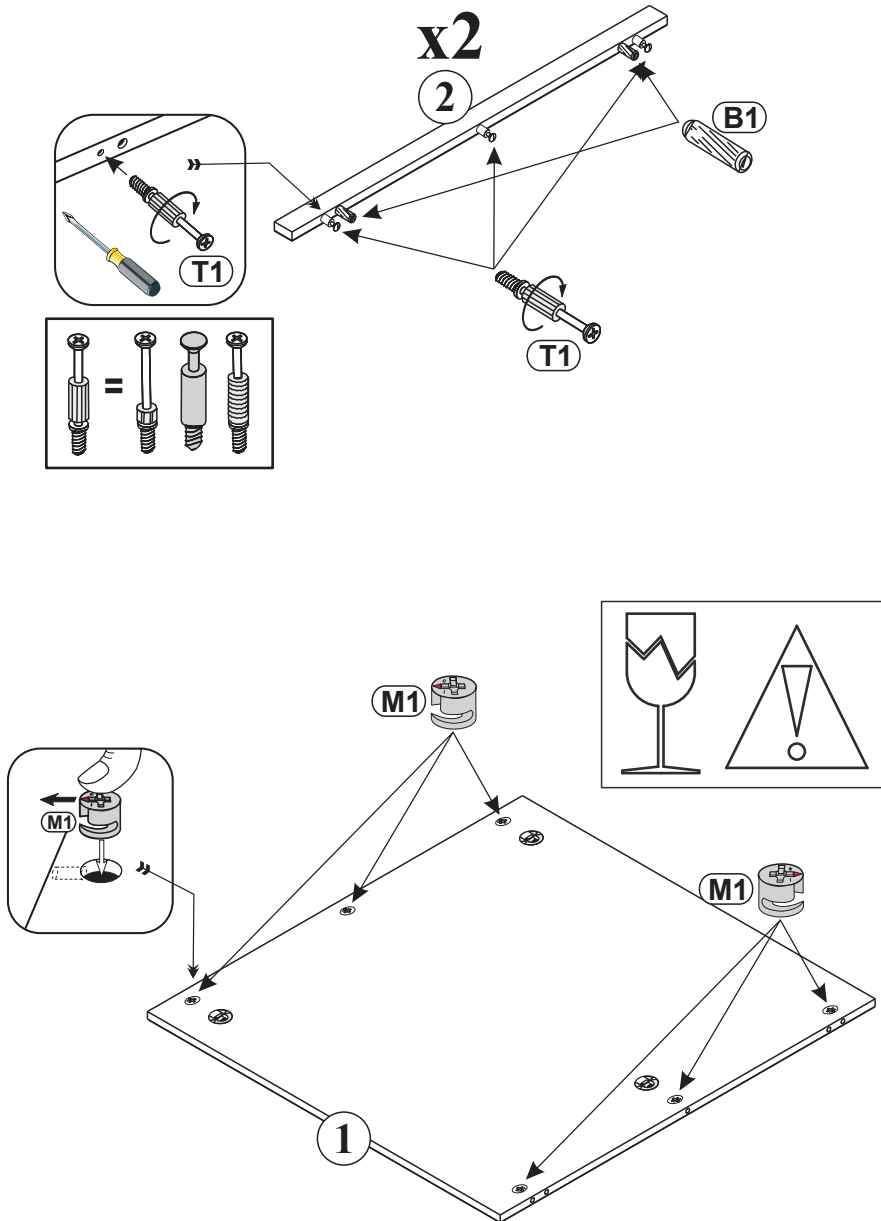
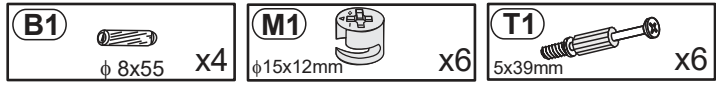

2

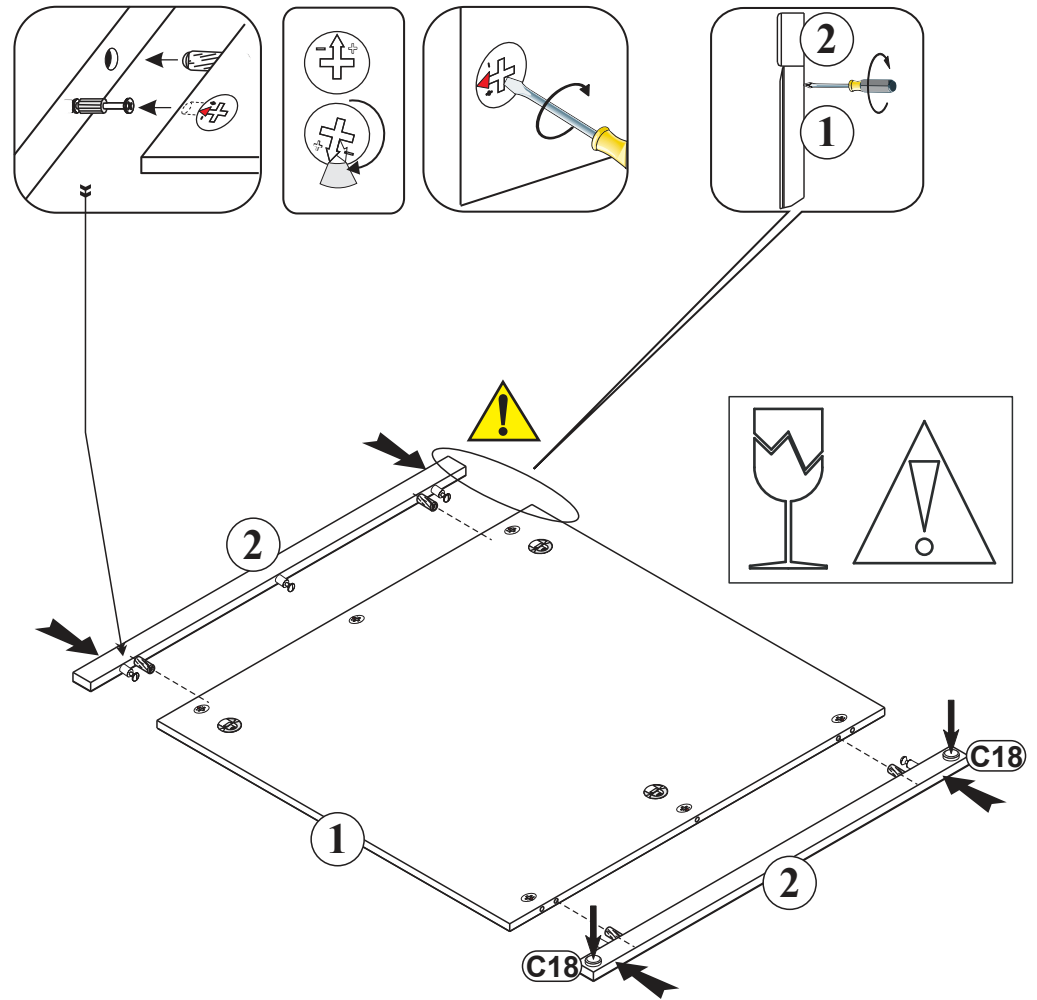
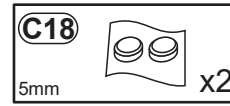

PERSIKO 6A02HH50

3

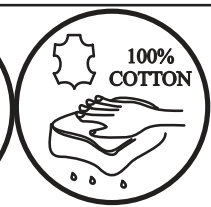
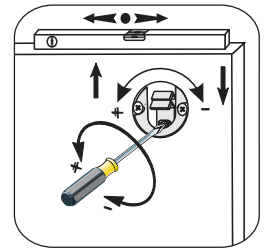
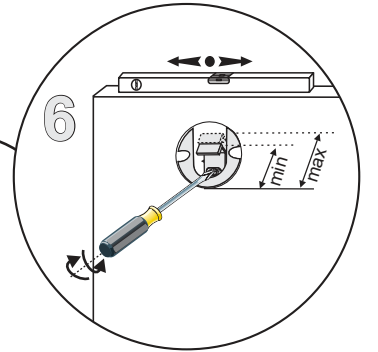
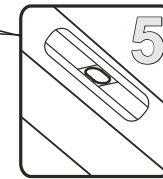
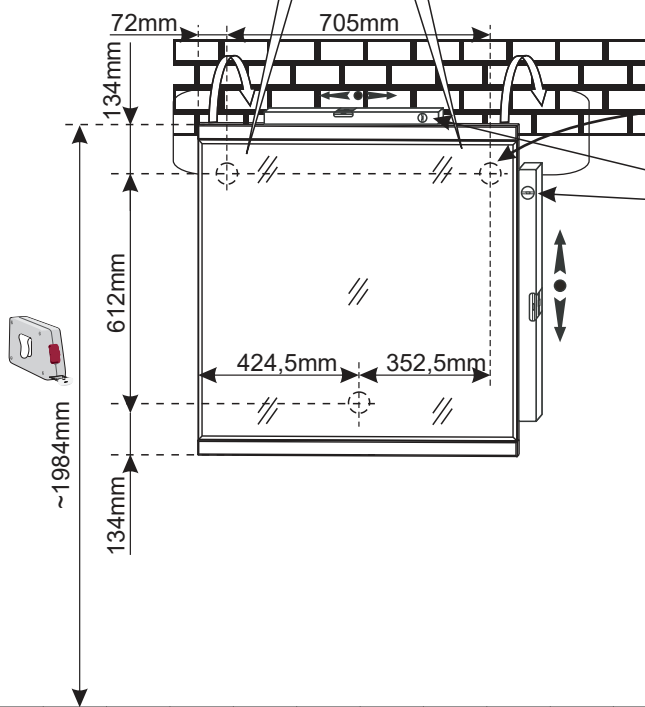
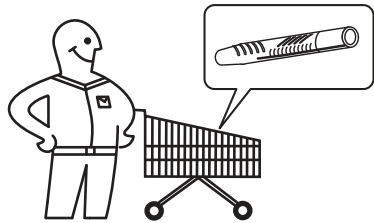
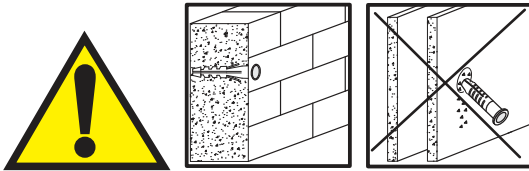
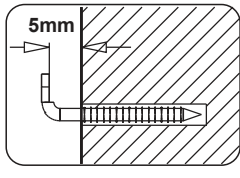
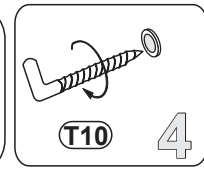
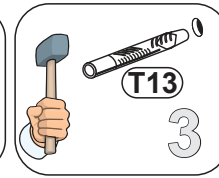
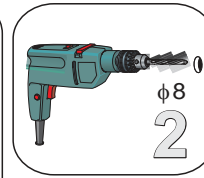
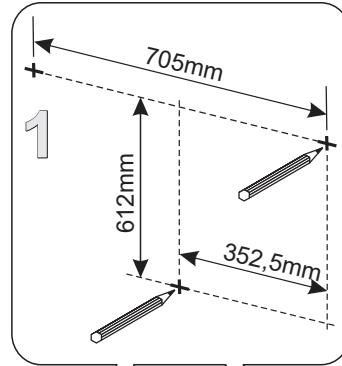
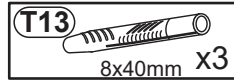
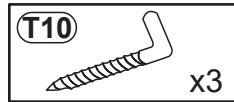
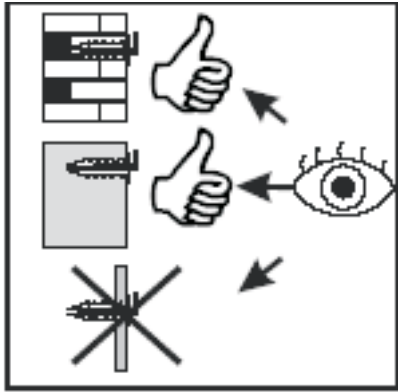

D CH AT LI LU	Kleinteile und Verpackungsfolien bei der Möbelmontage von Kindern fernhalten!
GB US	Keep small parts and plastic film out of the reach of children!
FR BE NC	Tenir les petites pièces et les films plastiques hors de la portée des enfants!
NL	Houd de kleine onderdelen en de plastic folie uit de buurt van kinderen!
IT	Tenere i componenti di piccole dimensioni e le pellicole di plastica fuori dalla portata dei bambini!
SI	Maljinhi delovni in embalažne folije pri montaži pohištva hranite izven dosega otrok!
XS HR BA	Maile dijelove i foliju za pakovanje priklom montaže namještaja držite dalje od djece
HU	Bütorészereles közbén a kis alkatrészek és a csomagoló fóliák gyerekektől távol tartandók!
BG	Дребни детайли и опаковъчни фолия да се държат далеч от деца при монтажа на мебелите!
CZ SK	Při montáži nábytku uchovávejte drobné díly a obalové fólie z dosahu dětí!
SE	Vid möbelformering ska smådelar och förpackningsfolien hållas oåtkomliga för barn!
RO	Tineți departe de copii piesele mici și folia de ambalat la montarea mobilierului!
ES	¡Durante el montaje, mantenga alejados de los niños las piezas pequeñas y el material plástico de embalaje!
D CH AT LI LU	Möbelmontage muss auf ebenem Untergrund erfolgen. Bei Wandmontagen immer geeignetes Befestigungsmaterial verwenden.
GB US	Furniture must be assembled on a flat surface. For assembly to the wall only use suitable fixing materials.
FR BE NC	Le meuble doit être monté sur une surface plane. Pour le montage mural, utilisez des accessoires de fixation adaptés au type de mur.
NL	De meubels dienen op een vlakke ondergrond te worden gemonteerd. Voor wandmontage moeten geschikte bevestigingsmaterialen worden gebruikt.
IT	Il montaggio dei mobili deve avvenire su un fondo piano. Per il montaggio si prega di utilizzare solo materiali adatti.
SI	Pohištvo je treba montirati na ravni podlagi. Pri stenski montaži vedno uporabite pritriljveni material.
XS HR BA	Namještaj se mora montirati na ravnoj podlozi. Kod montaže na zid uvijek koristite prikladan materijal za pričvršćivanje.
HU	A bútoraszereleést silk felületen kell végezni. Falra szereléshez mindig megfelelő rögzítanyagot kell használni.
BG	Монтажът на мебелите да се извършва на равна основа. При стънен монтаж виняги да се използва подходящ крепежен материал.
CZ SK	Montáž nábytku provádějte na rovném podkladu. Při montáži na stěnu používejte vždy vhodný příslušenací materiál.
SE	Montering av möbeln måste göras på jämnt underlag. Vid väggmontering ska lämpligt uppfästingsmaterial användas.
RO	Montarea mobilier trebuie să se realizeze pe o pardoseală dreaptă. La montarea la perete utilizati întotdeauna material de fixare adecvat.
ES	El montaje debe efectuarse sobre una superficie uniforme. En el montaje mural emplee siempre el material de fijación adecuado.
D CH AT LI LU	Bitte beachten Sie die Montageanleitung. Halten Sie immer die angegebenen Wattzahl ein. Verhindern Sie einen Hitzezustand.
GB US	Please observe the assembly instructions. Do not exceed the max. given wattage. Ensure that the heat is not allowed to build up.
FR BE NC	Veuillez respecter la notice de montage. Respectez impérativement le nombre des watts maximal. Veillez à éviter toute accumulation de chaleur.
NL	Lees a.u.b. de montagehandleiding door. Houd u beslist aan het max. orgegeven wattage. Zorg ervoor dat geen hitteopwarming onstaat.
IT	Attenersi alle istruzioni di montaggio. Rispettarsi rigorosamente il numero di watt max. indicato. Assicurarsi che non si verifichi un accumulo di calore.
SI	Prešitevalje navodila za montažo. Vedno upoštevajte navedeno število vatov. Preprečite zastoj vročine.
XS HR BA	Obratite pažnju! Vas pozor na uputu za montažu. Uvijek se pridržavajte navedenog broja vati. Izbjegavajte zastoj vrućine.
HU	Vegye figyelembe a szerelési útmutatót. Mindig tartsa be a megadott wattszámat. Akadályozza meg a hőelődést.
BG	Моля, вземете под внимание ръководството за монтаж. Спазвайте виняги посочените ватове. Избягвайте акумулиране на топлина.
CZ SK	Dodržujte prosím návod k montáži. Vždy dodržujte uvedenou hodnotu výkonu (watt). Zabráňte tak přehřívání.
SE	Följ monteringsanvisningen. Följ alltid angivet wattal. Undvik att hetta uppstår.
RO	Respectati instructiunile de montaj. Respectati întotdeauna numărul de watt impus. Evitați acumularea de căldură.
ES	Le rogamos que tenga presente las instrucciones de montaje. Respete siempre el número indicado de vatios. Evite la acumulación de calor.
D CH AT LI LU	Halten Sie die max. zulässigen Belastungswerte der Möbelteile ein. Details siehe Montageanleitung
GB US	Comply with the max. permissible loads. For details, please refer to the assembly instructions
FR BE NC	Respectez les valeurs de charge max. admissibles des parties de meubles. Pour plus de détails, cf. la notice de
NL	Houd de maximal geoorloofde belastingwaarden van de meubeldelen aan. Voor details verwijzen wij naar de montagehandleiding
IT	Rispettare la portata max. permessa degli elementi del mobile. Per dettagli si vedano le istruzioni di montaggio e si vada
SI	Prešitevalje največjo dovoljeno obremenitev delovih delov pohištva. Podrobnosti najdete v navodilih za montažo in na
XS HR BA	Pridržavajte se maks. dozvoljenih vrijednosti opterećenja elemenata namještaja. Detalje vidj u uputi za montažu
HU	Tartsa be a bútorelemek max. megengedett terhelési értékeit. A részleteket lásd a szerelési útmutatóban
BG	Спазвайте макс. допустимите стойности на натоварване на мебелите. За подробности виж ръководството за монтаж
CZ SK	Dodržujte max. přípustné hodnoty zatížení nábytkových dílů. Podrobnosti viz návod k montáži
SE	Följ max. tillåtna belastning av möbeldelarna. Mer information finns i monteringsanvisningen
RO	Respectati valoarea de solicitare max. admise pentru corpurile de mobilier. Pentru detalii consultati instructiunile de montaj
ES	Respete los valores máximos de carga admisibles para las piezas de los muebles. Consulte los detalles en las instrucciones
D CH AT LI LU	Zur Möbelreinigung ein mit Wasser befeuchtetes, fusselfreies Baumwolltuch verwenden. Geeignigte Flächen immer trockenreiben!
GB US	To clean the furniture only use a water dampened lint-free cotton cloth. Once cleaned, always wipe the surfaces dry.
FR BE NC	Utilisez un chiffon en coton non pelucheux humidifié avec de l'eau pour nettoyer les meubles. Séchez systématiquement les surfaces
NL	nettooyés en les trottant!
IT	Gebruik een met water bevochtigde, pluiscvrije katoenen doek om de meubels te reinigen. Wrijf gereinigde oppervlakken altijd droog!
SI	Per puļliti il mobile utilizzare un panno di cotone inumidito d'acqua e che non perde pelucchi. Asciugare sempre le superfici che si sono
XS HR BA	puļliti!
HU	Za čišćenje pohištva uporabljajte vlažno bombažno krpo, ki ne pušča vlaken. Očiščene površine vedno obrišite do suhlega!
BG	Za čišćenje namještaja koristite sa vodom navlaženu pamučnu krpu koja ne ispušta vlakna. Očišćene površine uvijek obrišite suhom
CZ SK	prosti kromi!
SE	Bütorisztításhoz vizzel benedvesített, nem szárazodó pamukkenőt használjon. A megtisztított felületeket mindig törölje szárazra!
RO	För möbelföringning används en luddfri bomullscduk fuktad med vatten. Rengörda ytor ska alltid torikas torra!
ES	Pentru curăţarea mobilierului utilizaţi o lavetă din bumbac fără scame umezită cu apă. Suprafeţele curăţate se şterg întotdeauna până se usucă!
	Emplee un paño de algodón humedecido con agua y libre de pelusa para la limpieza de los muebles. ¡Seque siempre las superficies que ha limpiado!