

# PABLO 30-H5HG-61

1

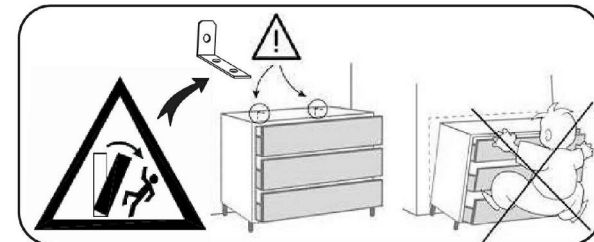
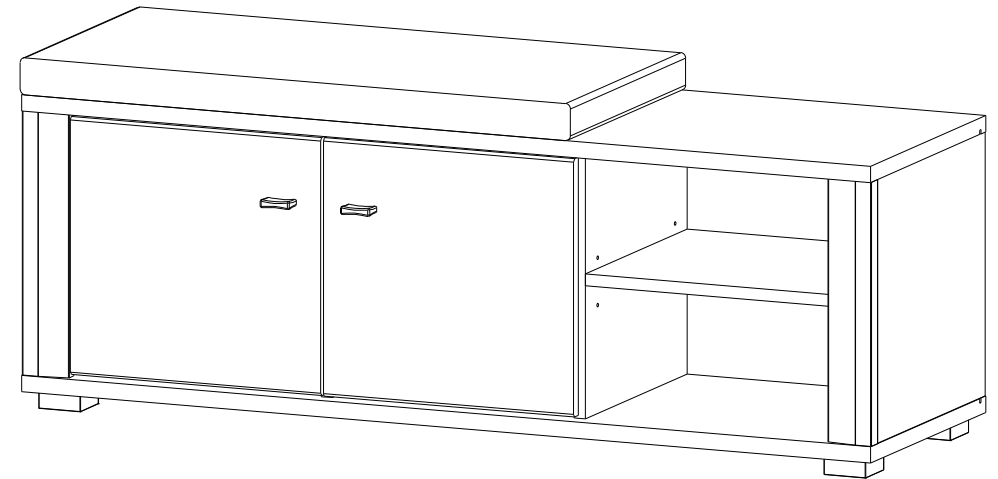
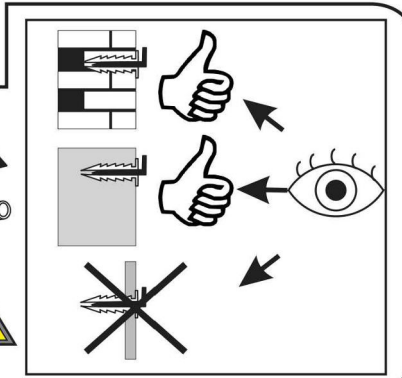
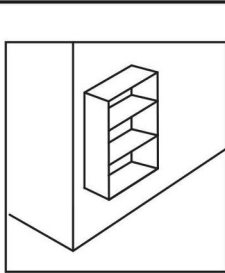
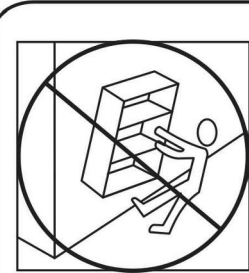
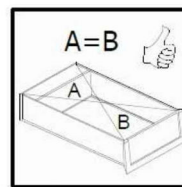
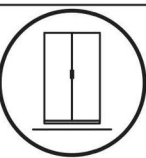
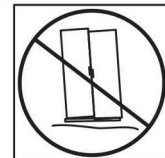
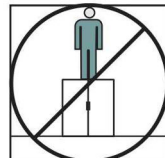
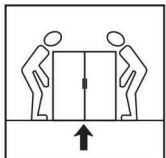
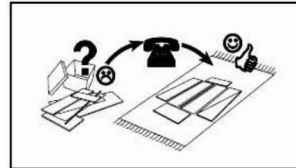
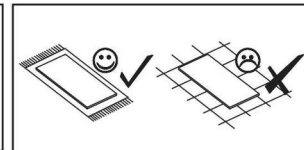
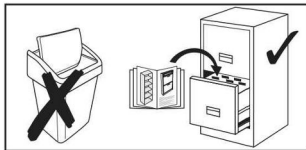
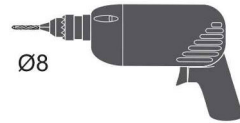
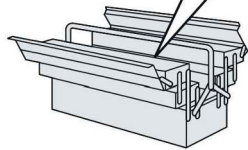
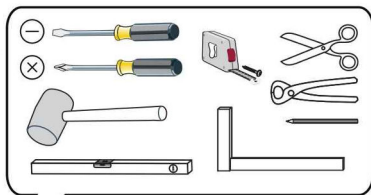
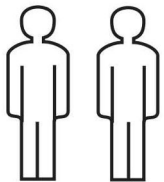

# PABLO 30-H5HG-61

2

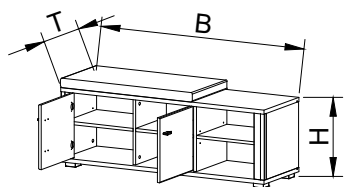

B - 1225  
H - 475  
T - 380

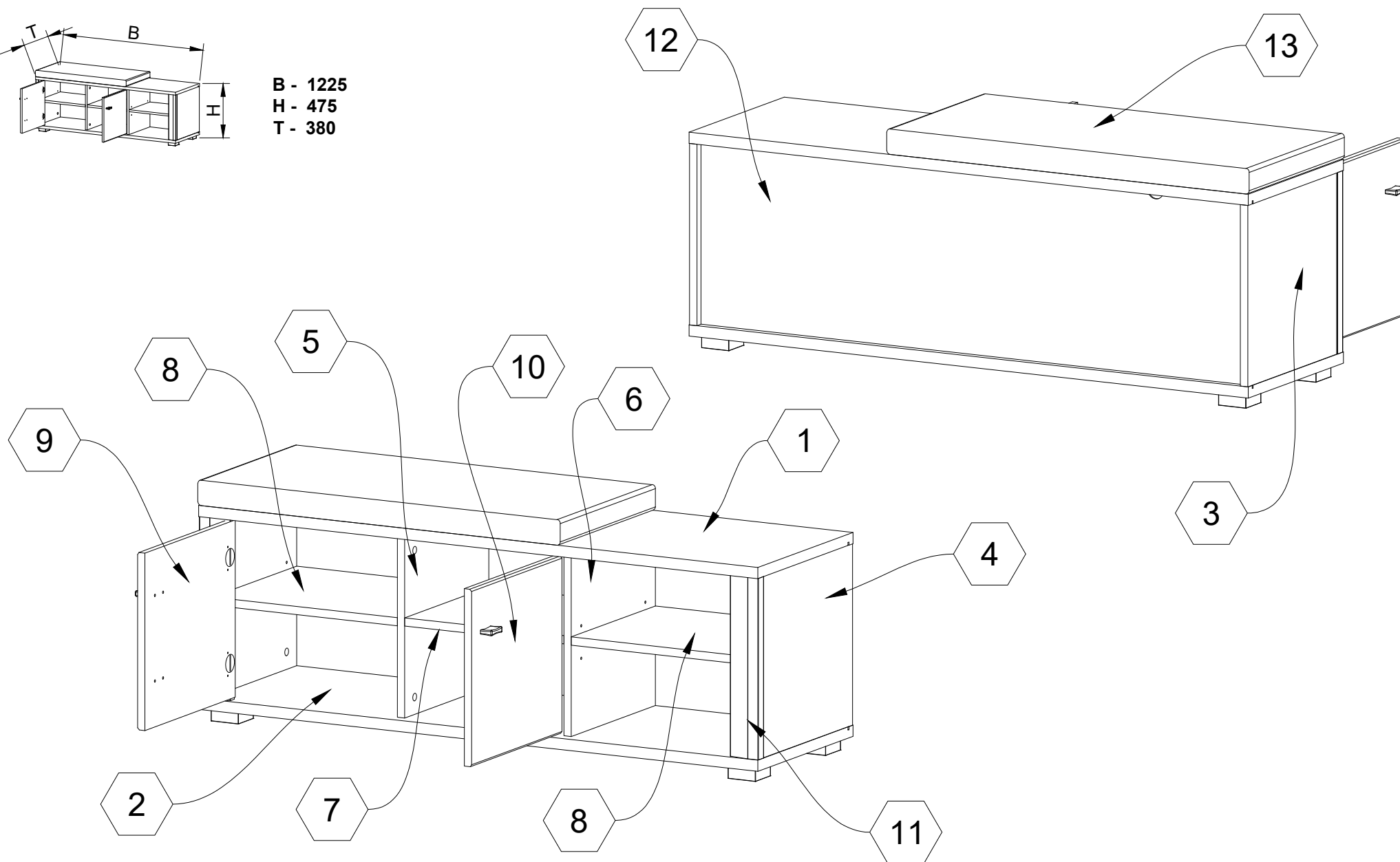

# PABLO 30-H5HG-61

3

B - 1225  
H - 475  
T - 380

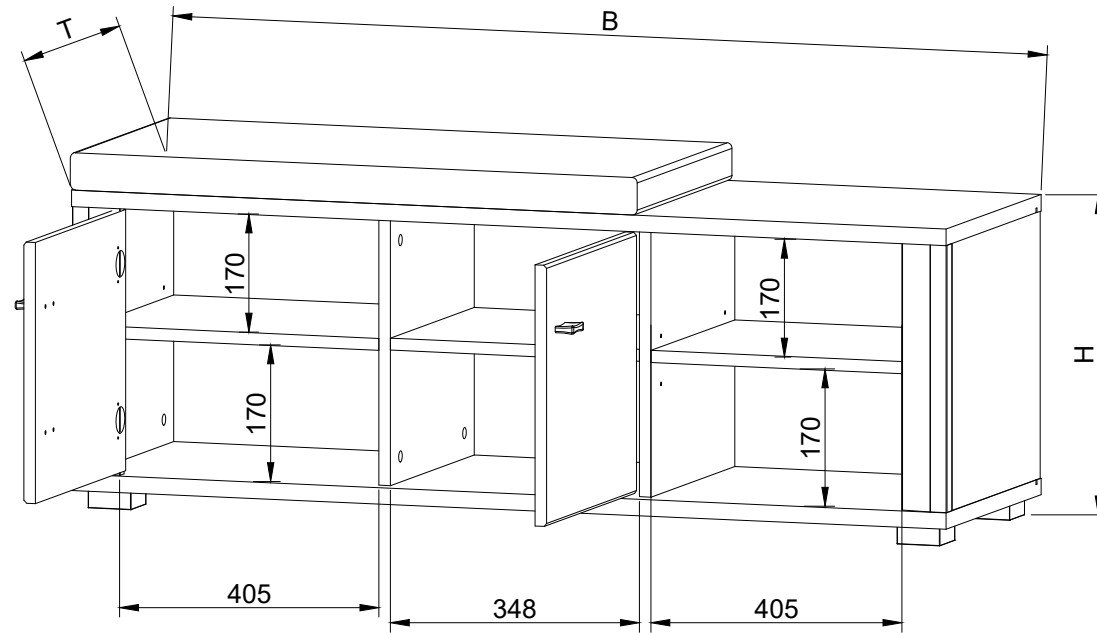





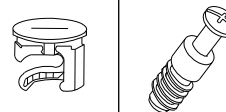
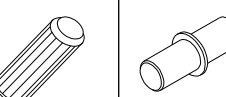
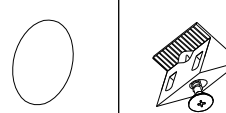
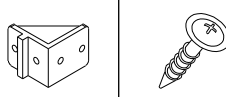
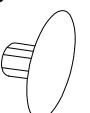

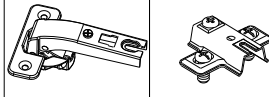
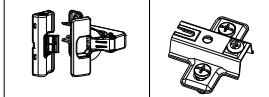
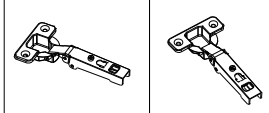
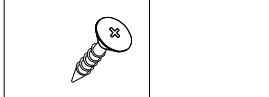
No.	Lenght	Width	Thickness	Quantity	Package No.
1	1225	380	22	1	1
2	1225	380	22	1	1
3	356	356	16	1	1
4	356	356	16	1	1
5	356	336	16	1	1
6	356	336	16	1	1
7	349	336	16	1	1
8	405	336	16	2	1
9	348	361	16	1	1
10	348	361	16	1	1
11	356	65	22	2	1
12	1201	366	3	1	1
13	858	380	50	1	1

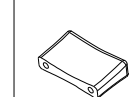
# PABLO 30-H5HG-61

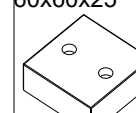
	
A x20	B x20
	
C x20	F x8
	
N x20	E x14
	
H x4	H1 x16
	
N2 x4	

	
Z x1	ZP x2
	
Z1 x1	ZP1 x2
	
Z2 x1	Z3 x1
	
ZS x8	

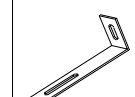
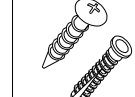
	
L-40mm	
U x2	
	
U1 x4	
	
60x60x25	
SM x6	
	
	
SM1 x12	

	
M x1	
	
M1 x1	
	
	
M2 x2	

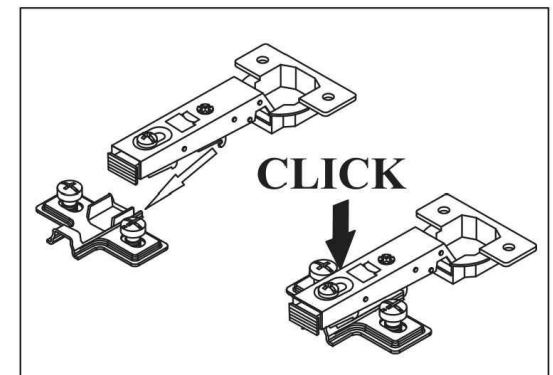
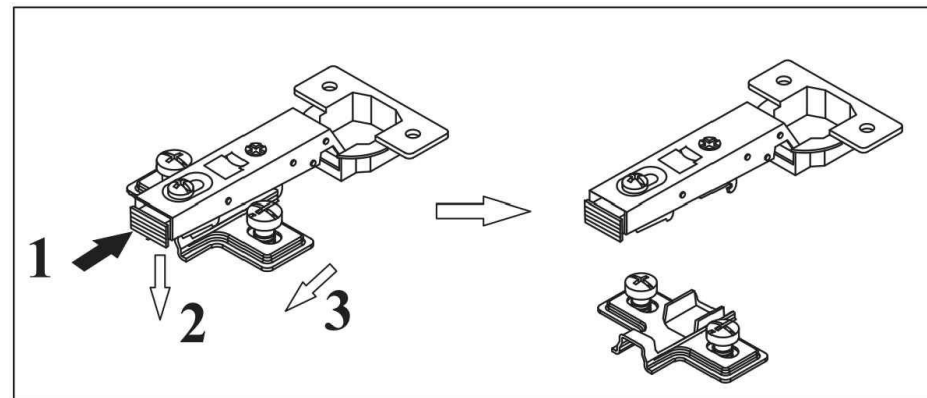

# PABLO 30-H5HG-61

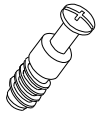
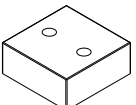

5

# 1

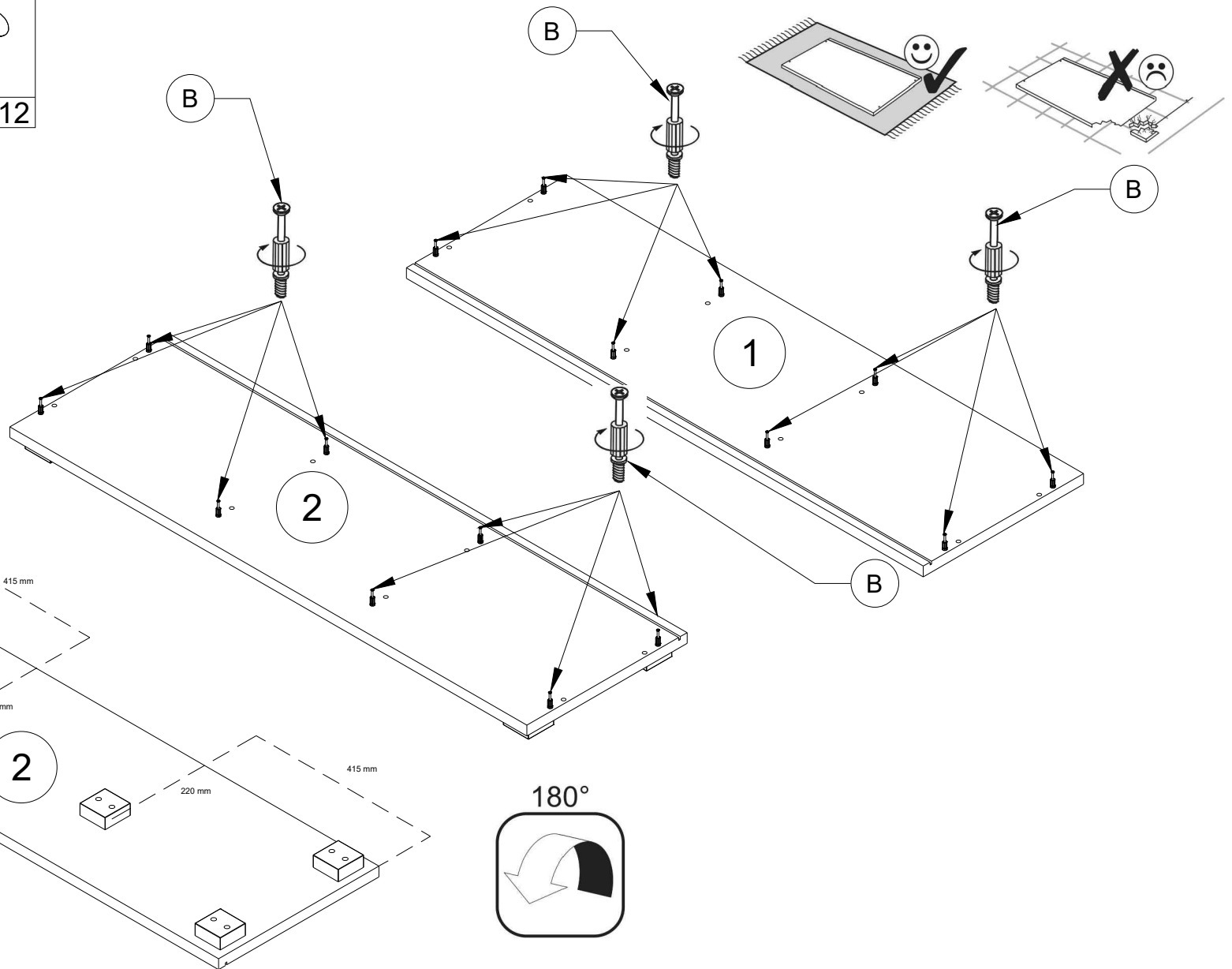
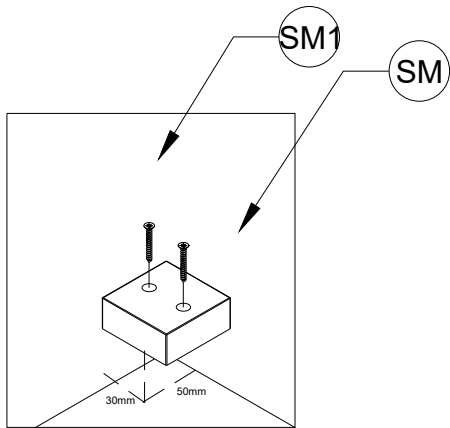
	60x60x25	Ø4x35mm
		
B x16	SM x6	SM1 x12

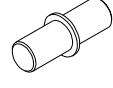

# 2

Ø15x12mm		Ø8x30mm			
					
A	x8	C	x8	F	x4

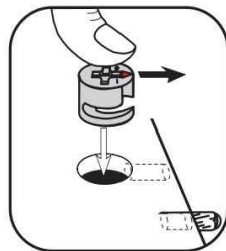
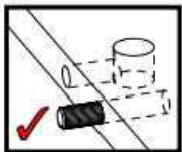
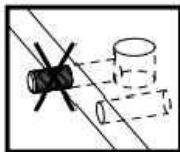
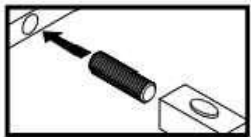
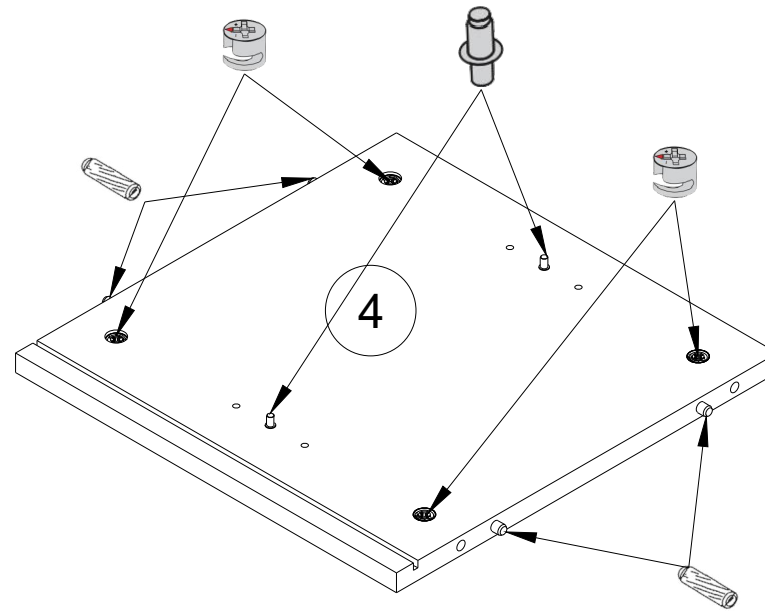
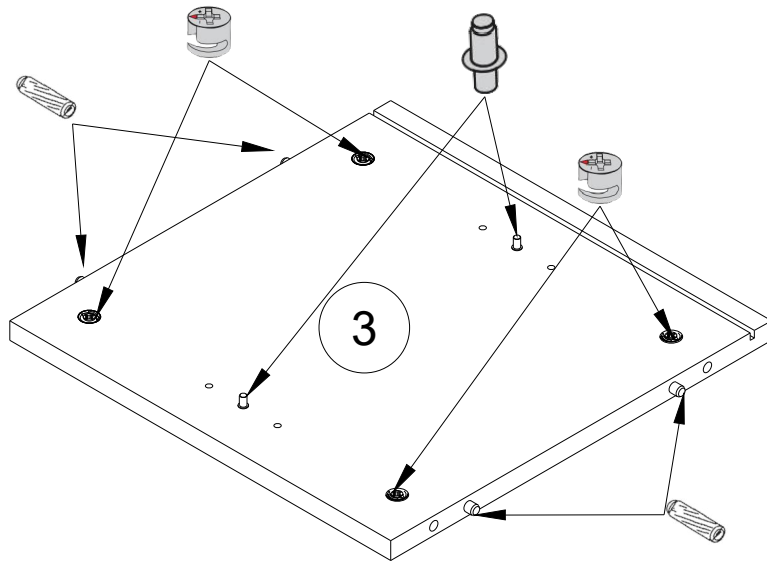
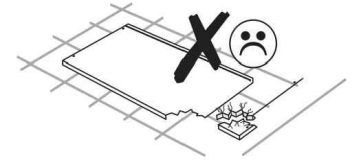
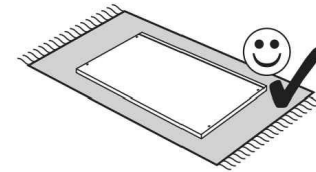

# PABLO 30-H5HG-61

# 3

30x30mm	Ø3,5x13mm						
H	x4	H1	x8	ZP	x1	ZP1	x1

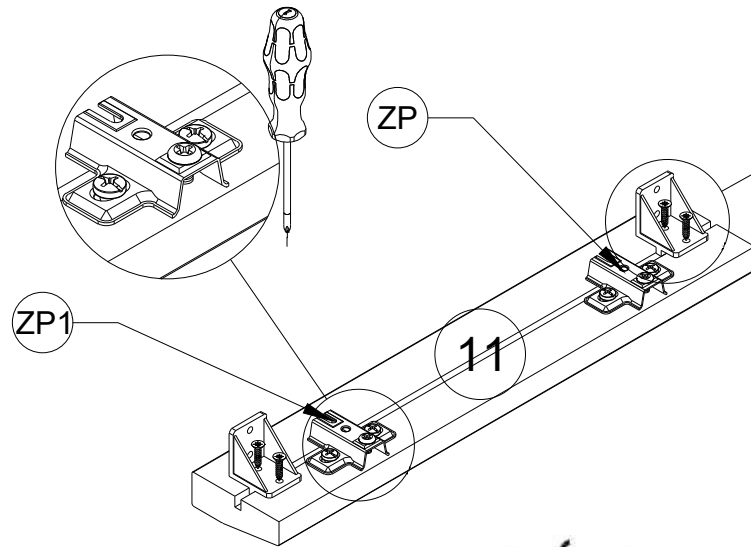
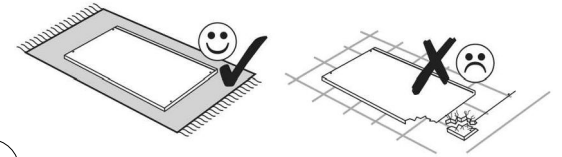

LEFT SIDE

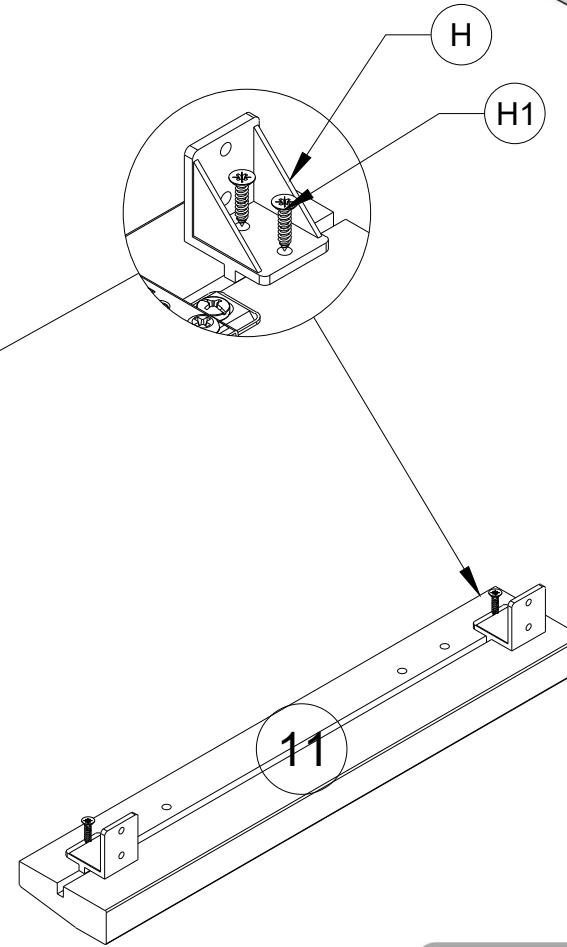
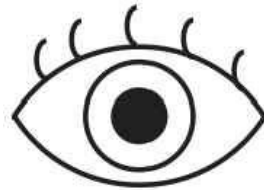

RIGHT SIDE

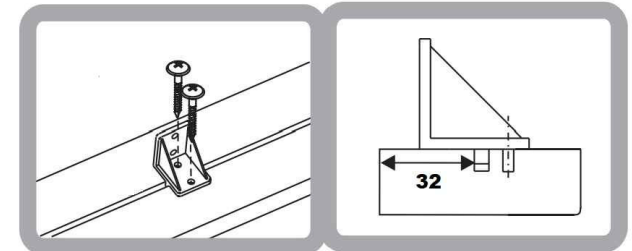

# PABLO 30-H5HG-61

8

# 4

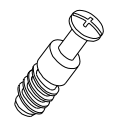
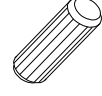
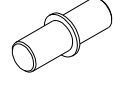
Ø15x12mm		Ø8x30mm	
			
A	x4	B	x2
C	x4	F	x2

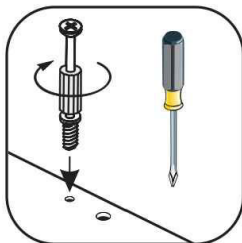
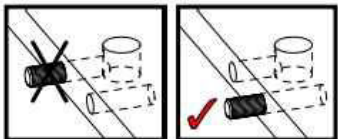
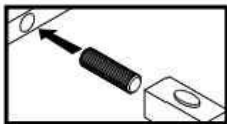
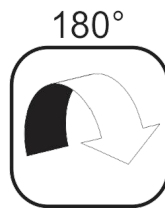
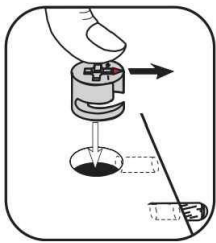
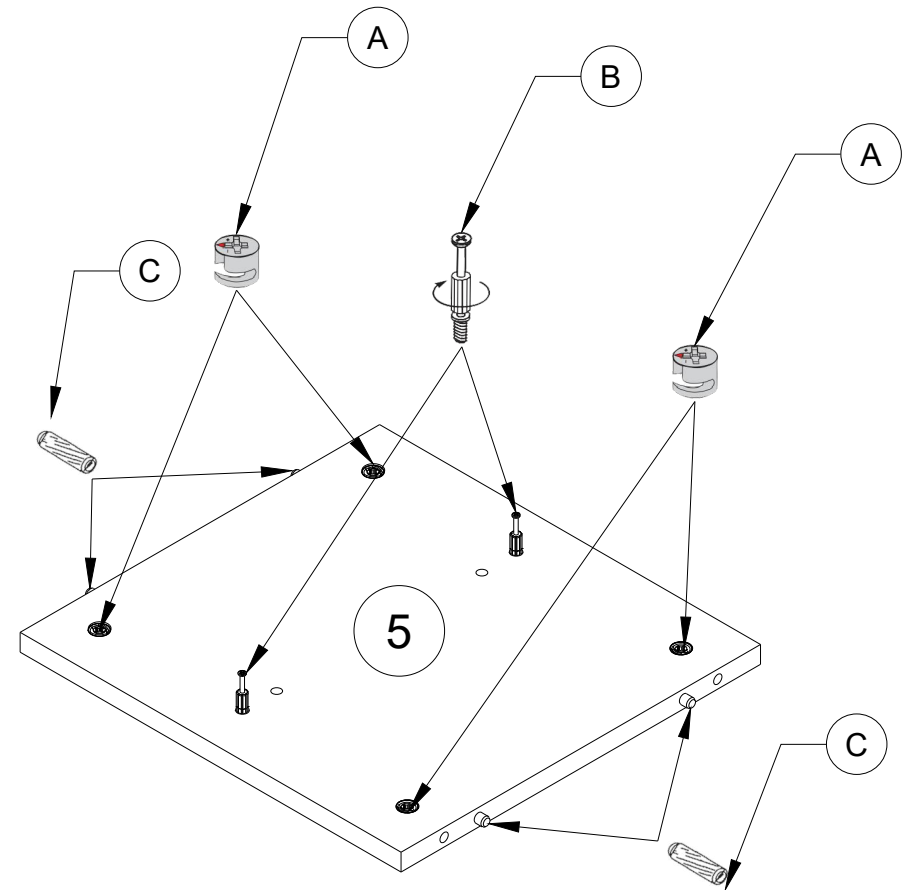
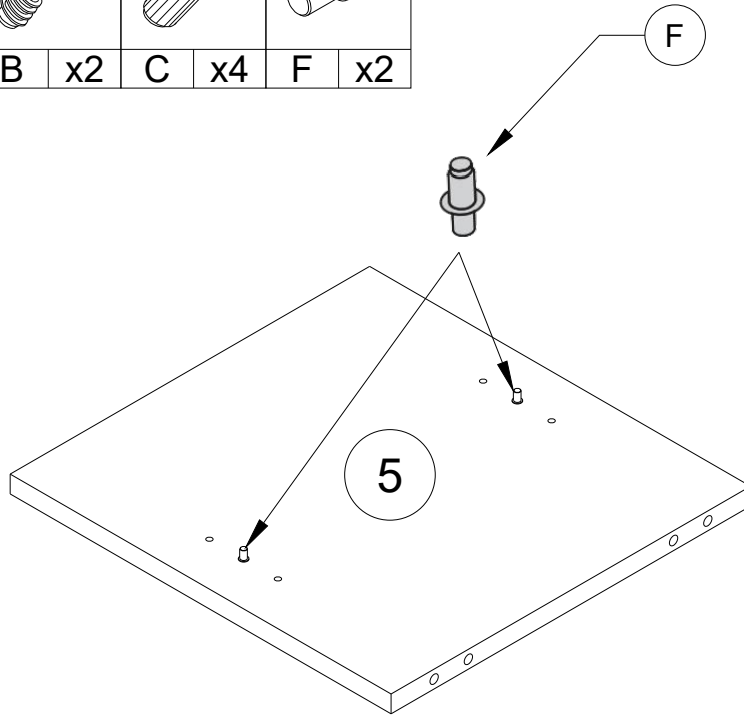
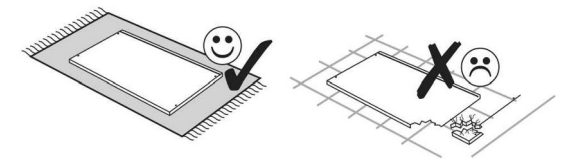



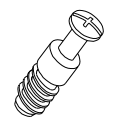
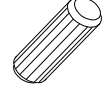
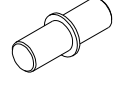
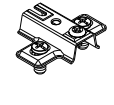

# PABLO 30-H5HG-61

# 5

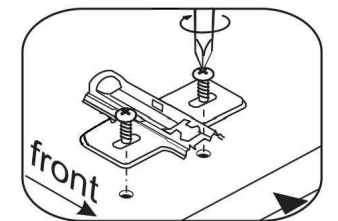
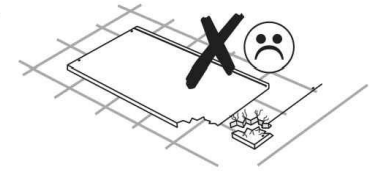
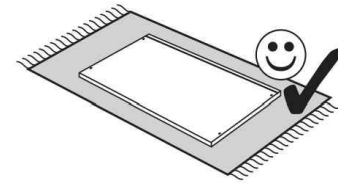
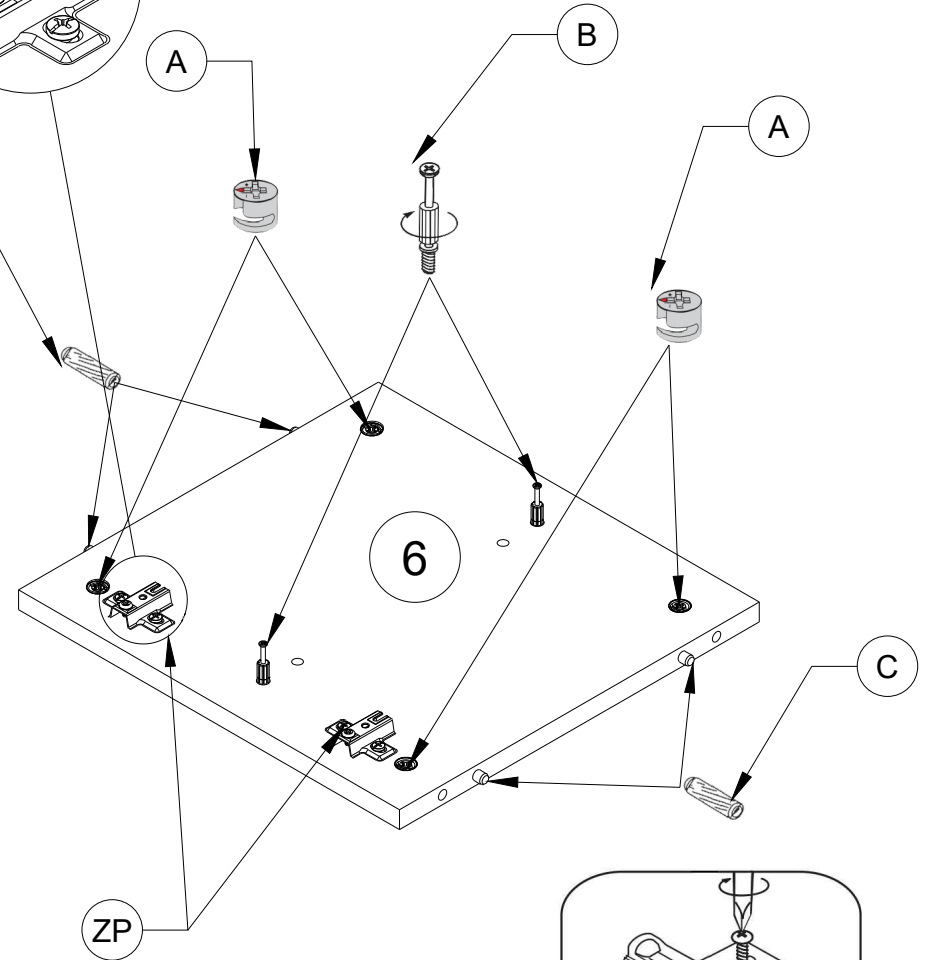
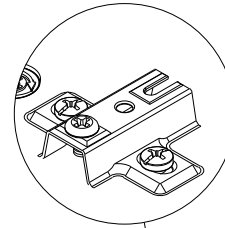
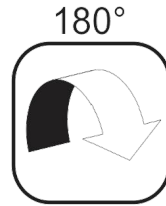
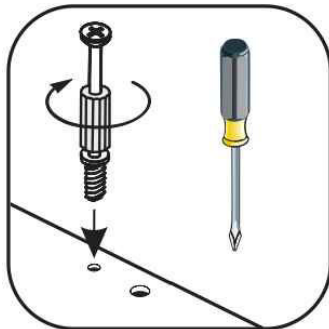
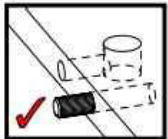
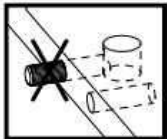
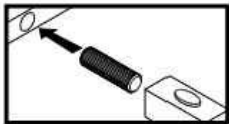
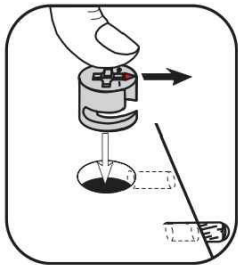
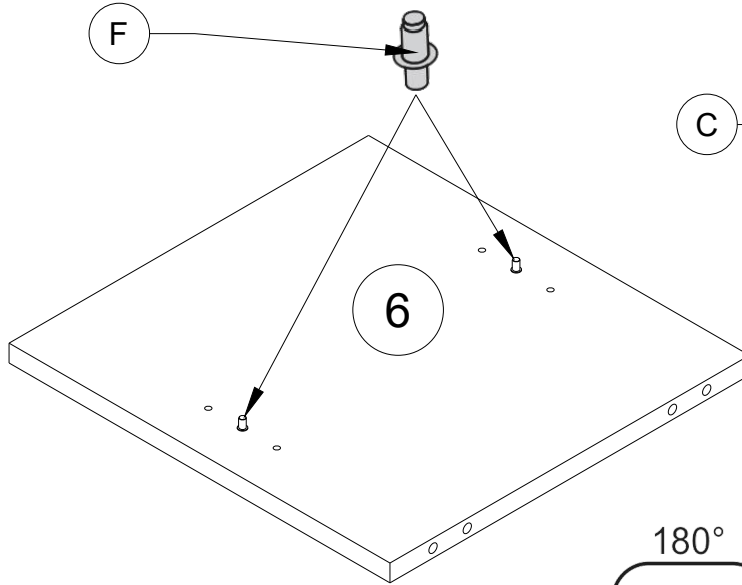
Ø15x12mm		Ø8x30mm			
					
A	x4	B	x2	C	x4
				F	x2
				ZP	x2



## 6

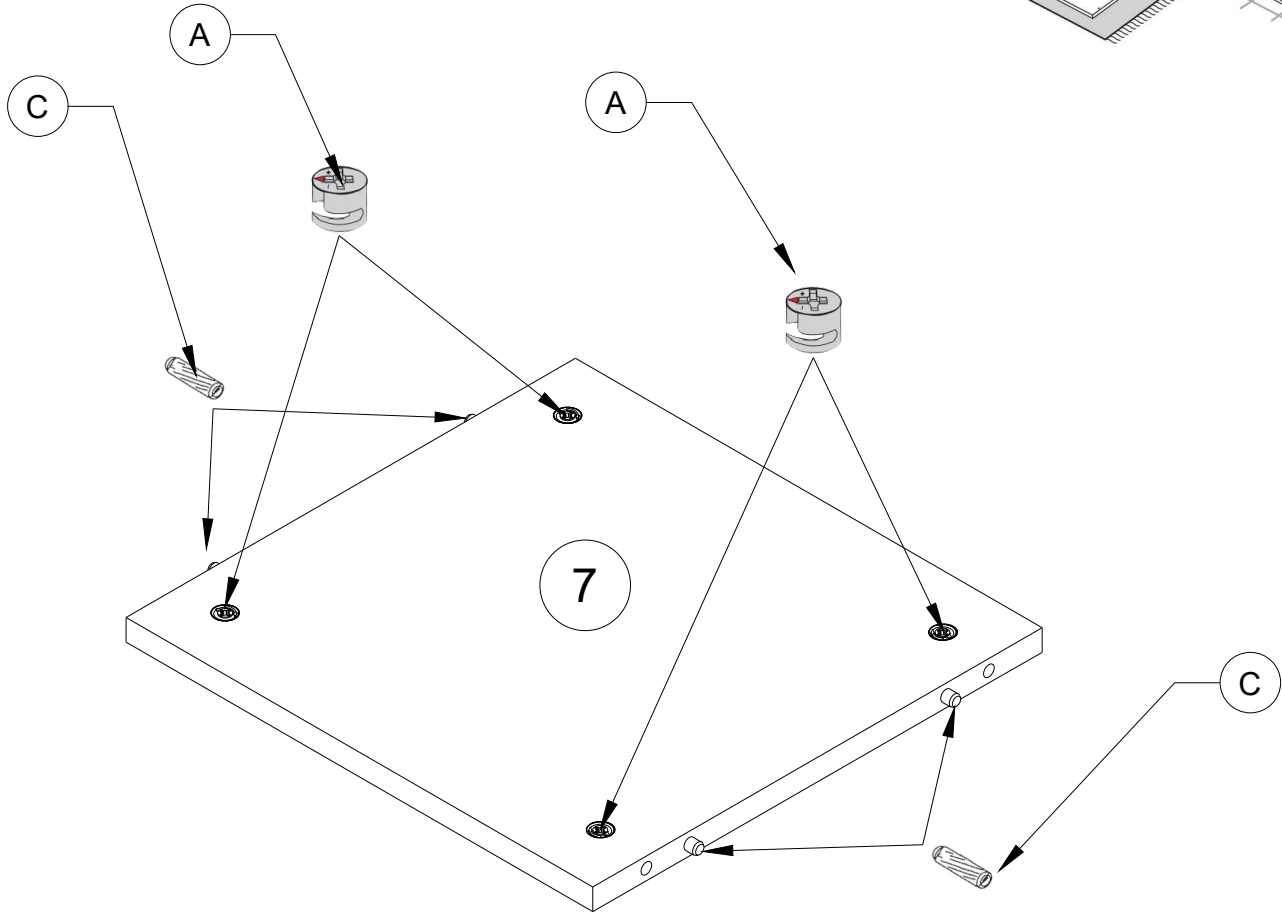
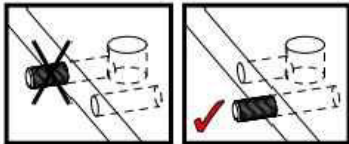
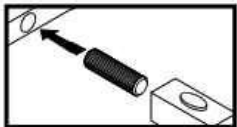
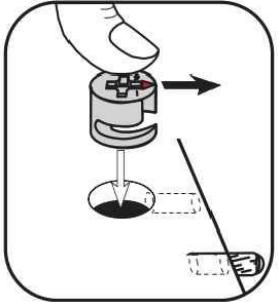
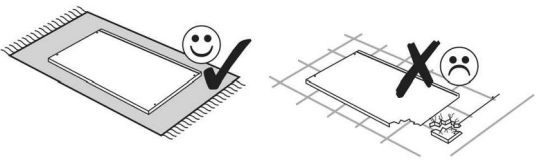

Ø15x12mm	Ø8x30mm
	
A x4	C x4



# PABLO 30-H5HG-61

11

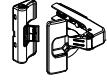
# 7

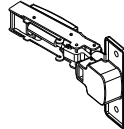
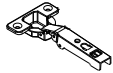
							
Z	x1	ZS	x8	Z2	x1	Z3	x1

Ø3,5x13mm

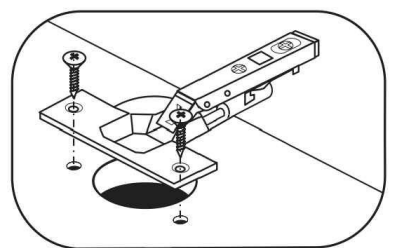
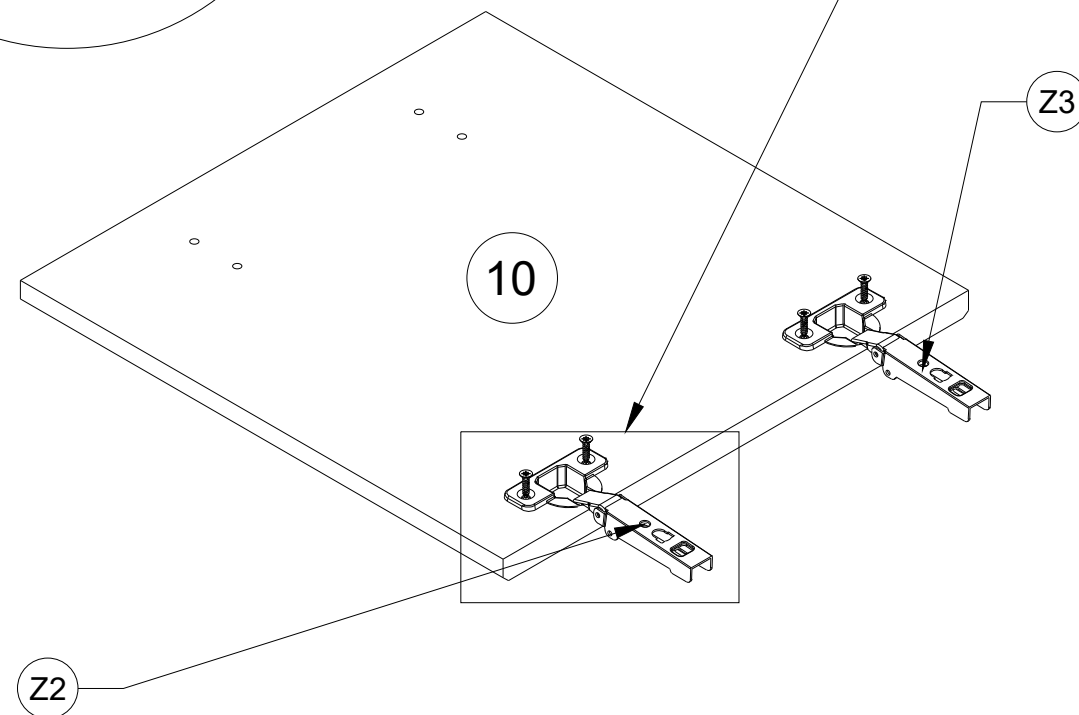
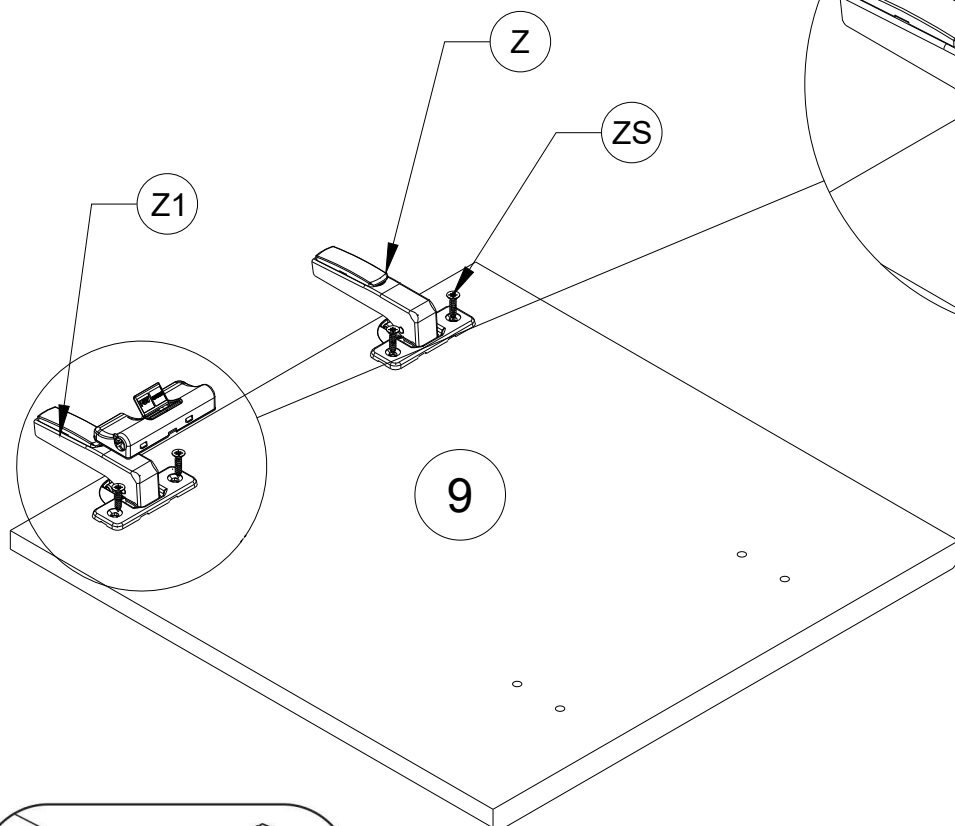
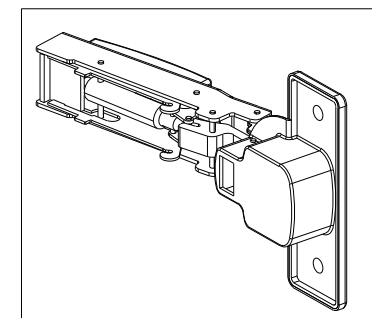
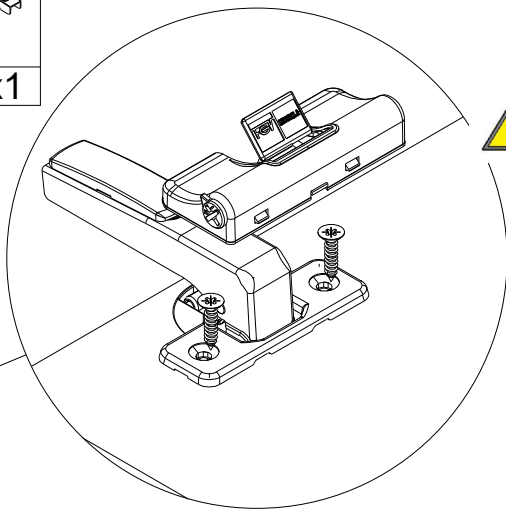
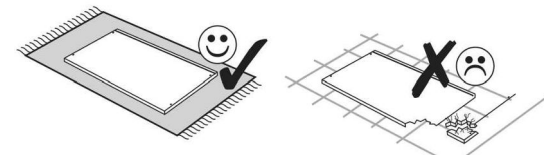

8

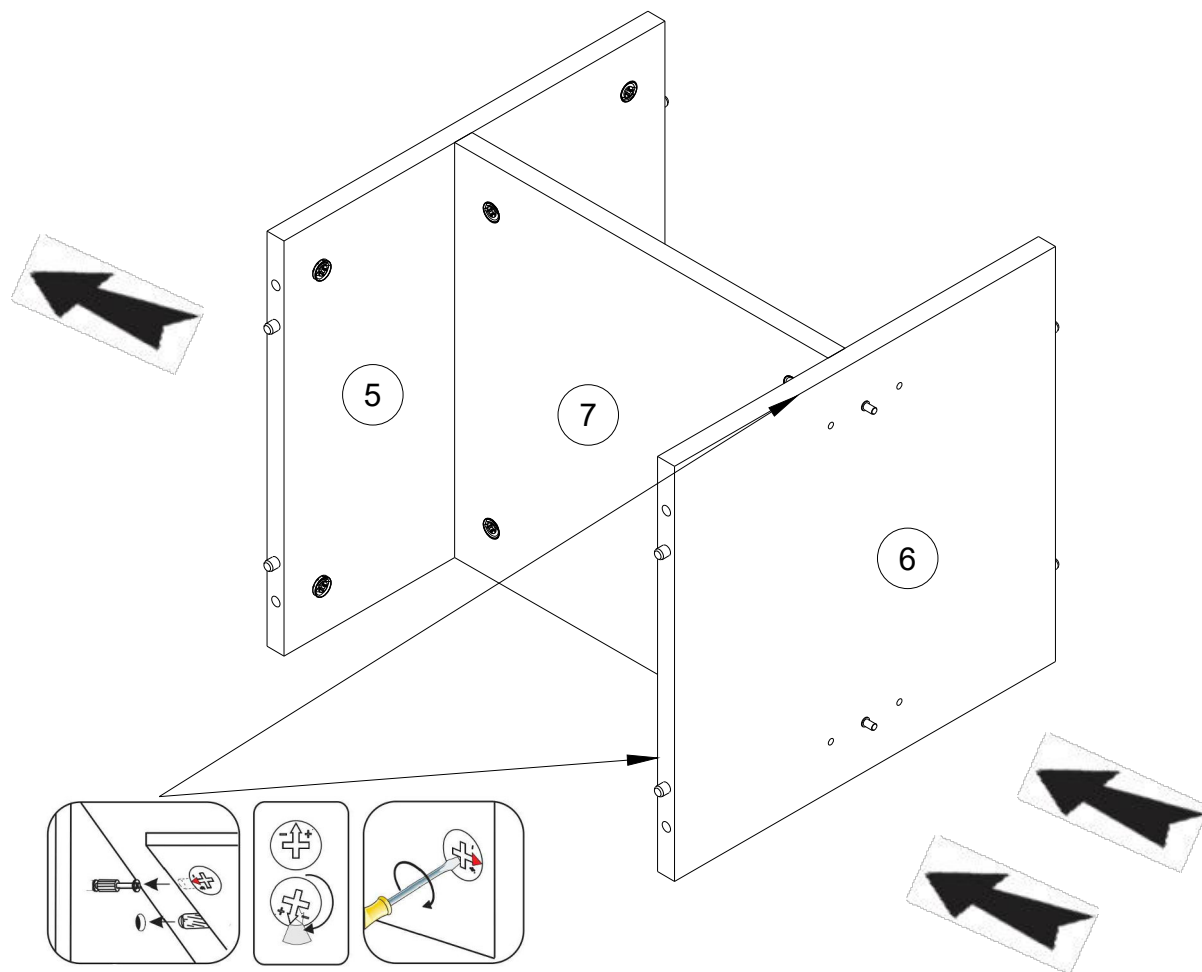
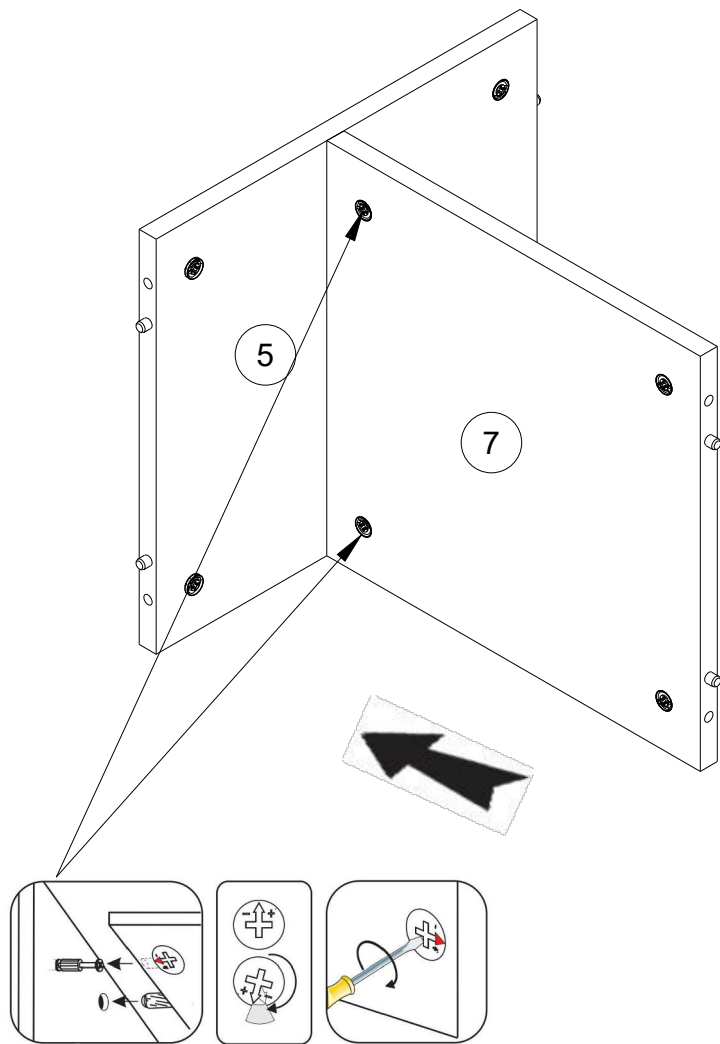
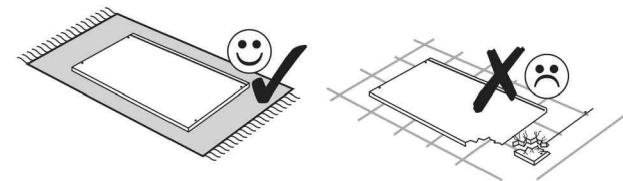
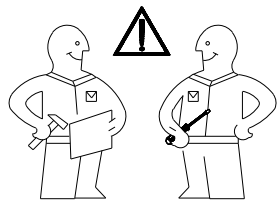

9

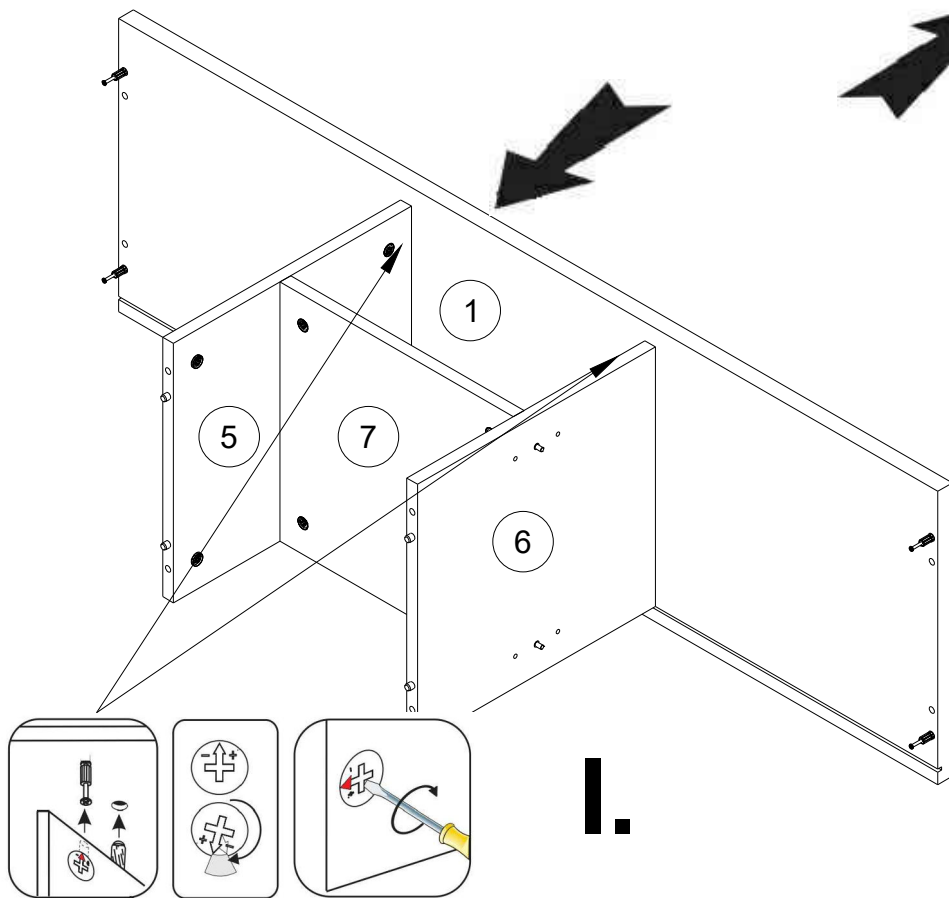
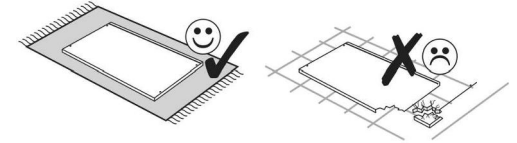
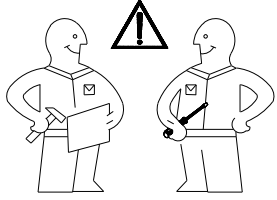

I.

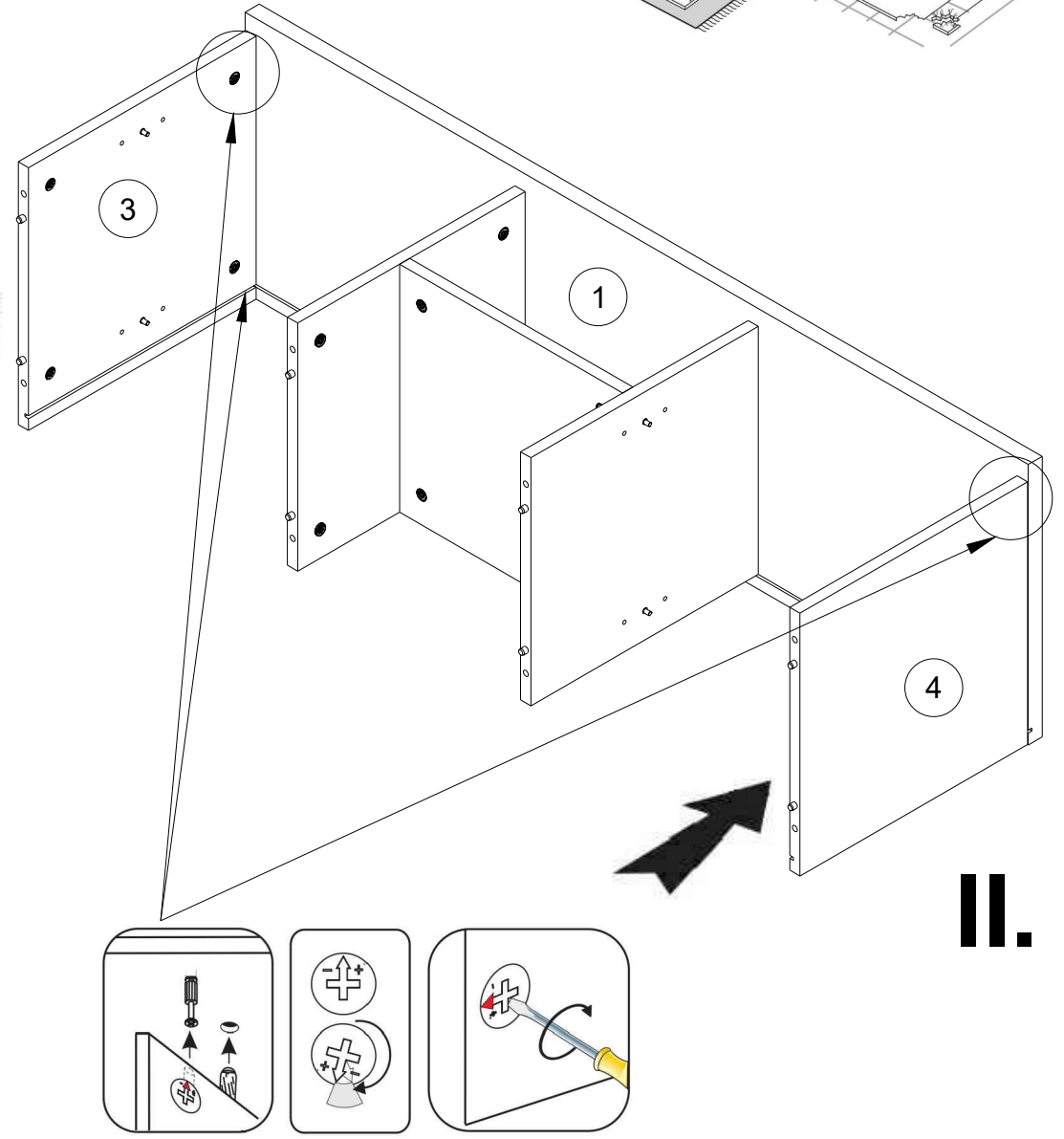

II.

10

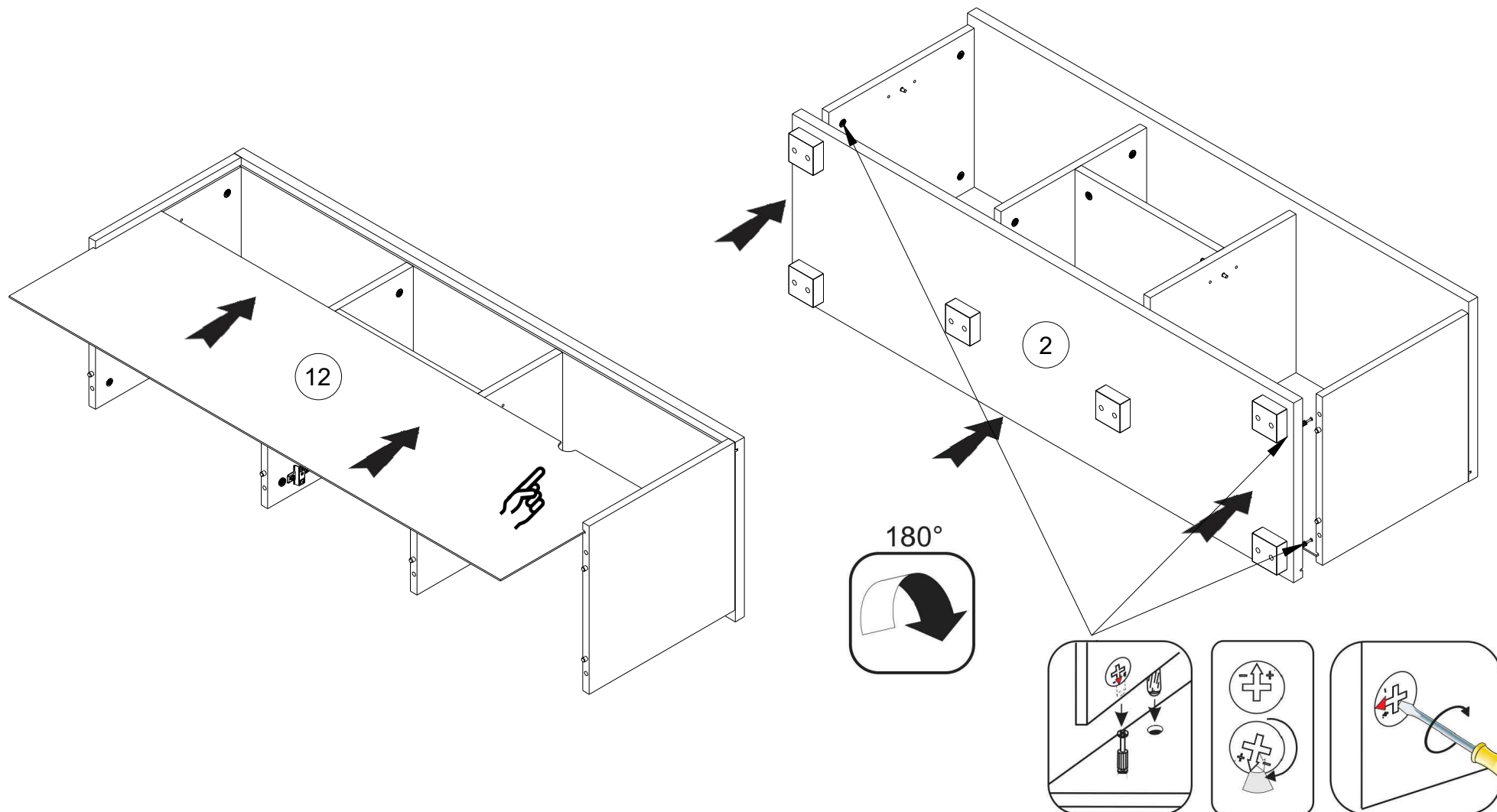
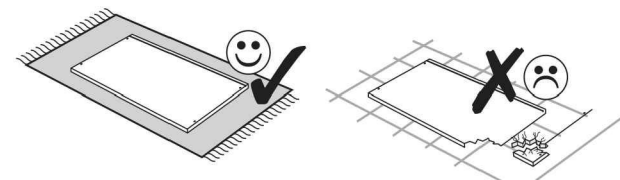
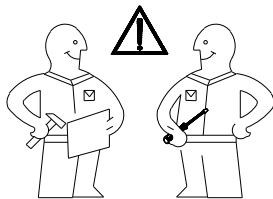

11

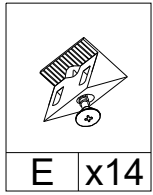

12

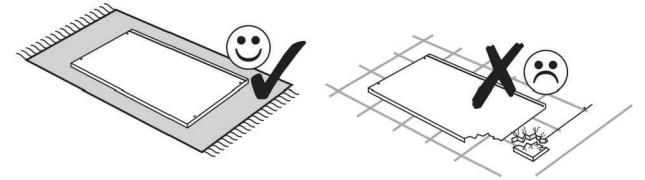
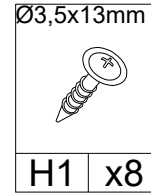

LEFT

RIGHT

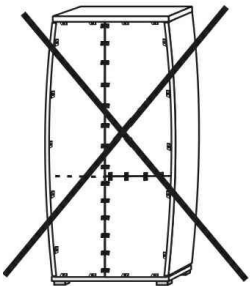
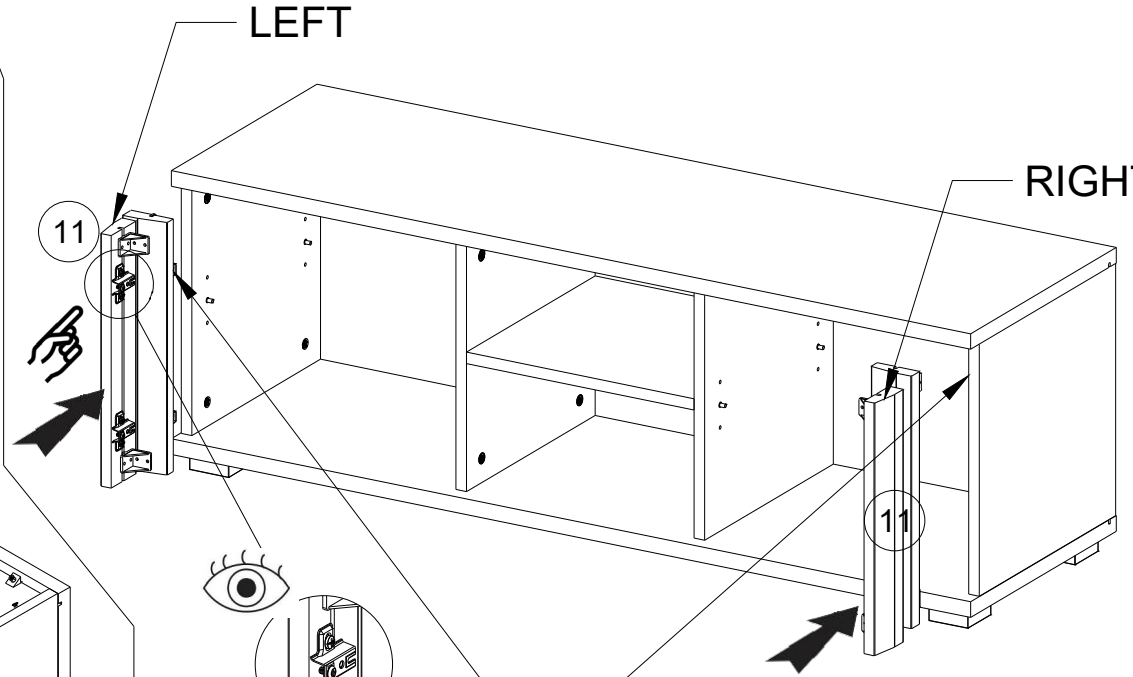
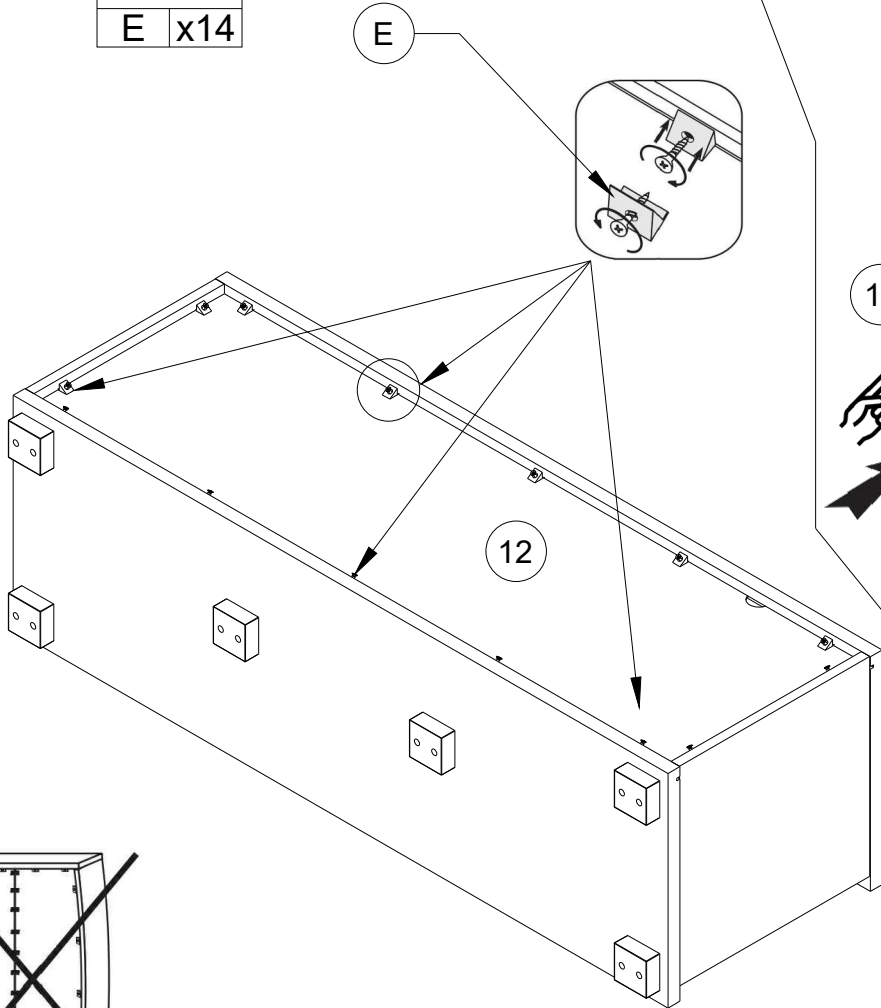

H1

# 13

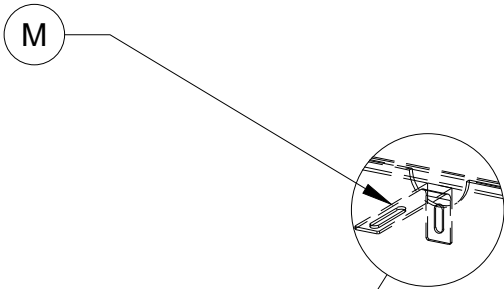
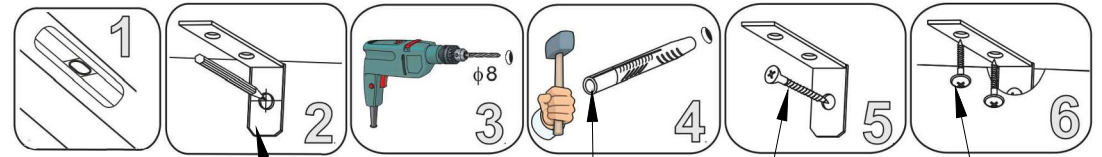



M

M1

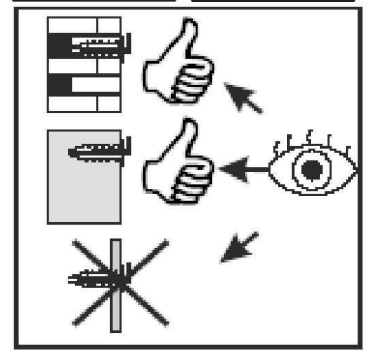
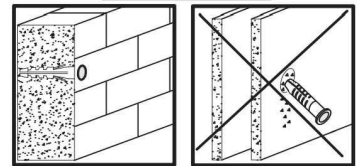
M2

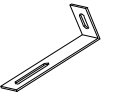

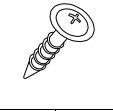
-  M x1
-  M2 x1  
Ø3,5x13mm
-  M2 x2

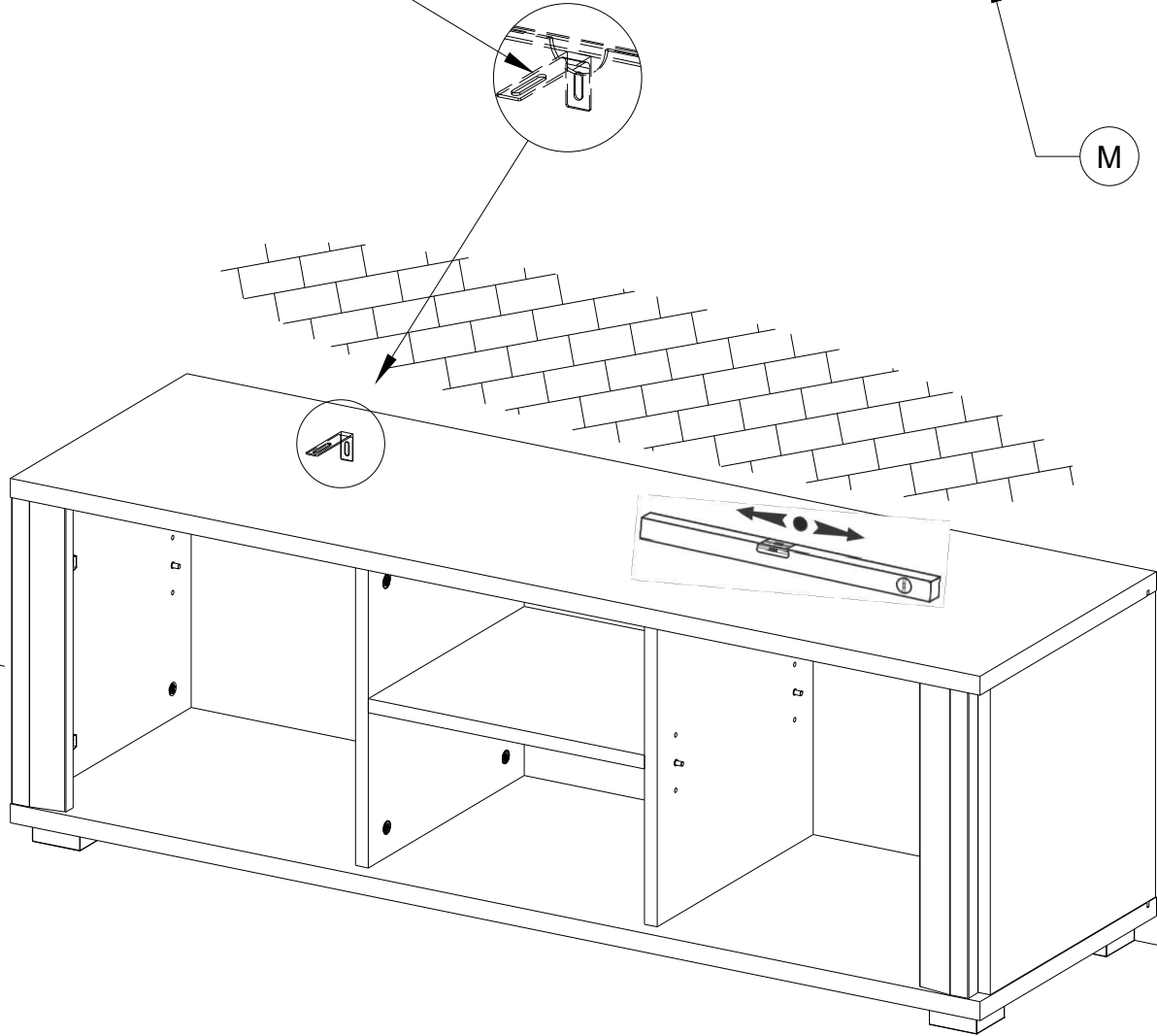



15



Z1

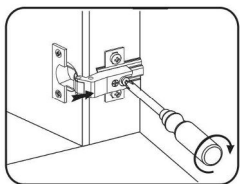
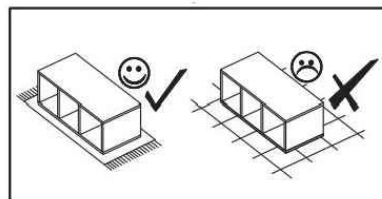

x2

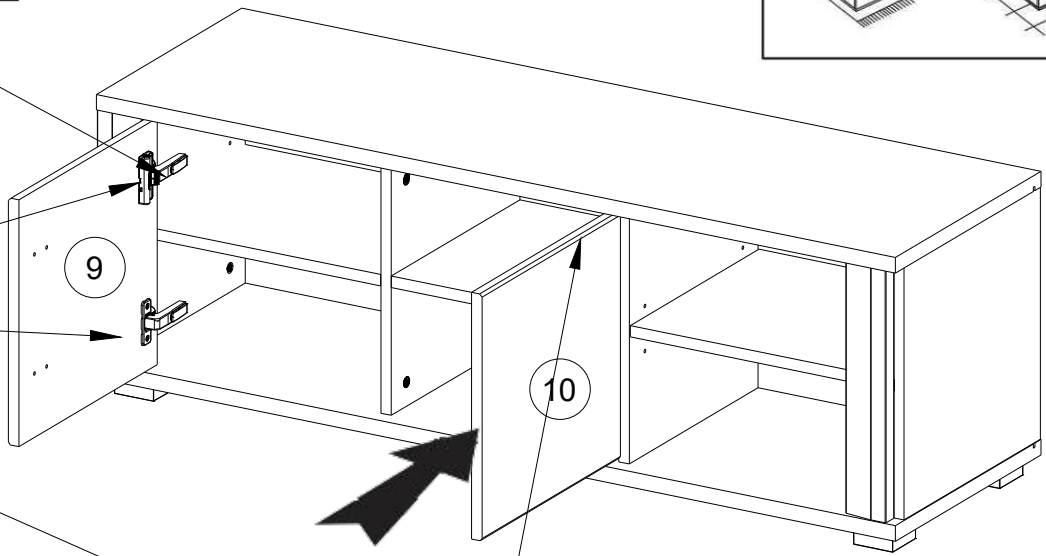

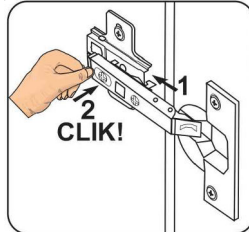
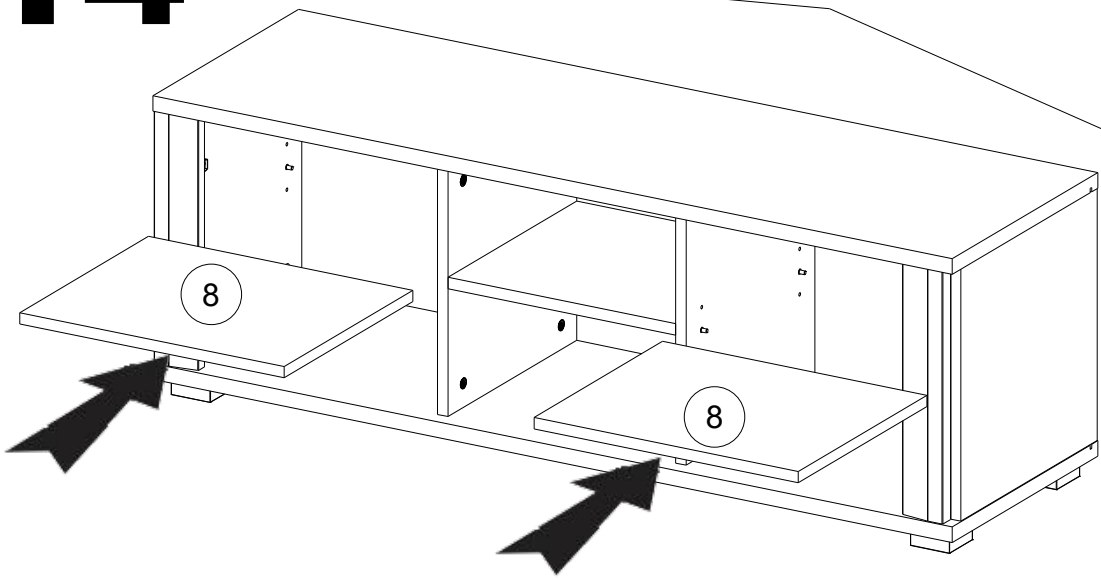

14



Z2



# 16

L-40mm	Ø5	
		
U x2	U1 x4	N2 x4

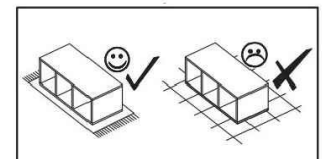
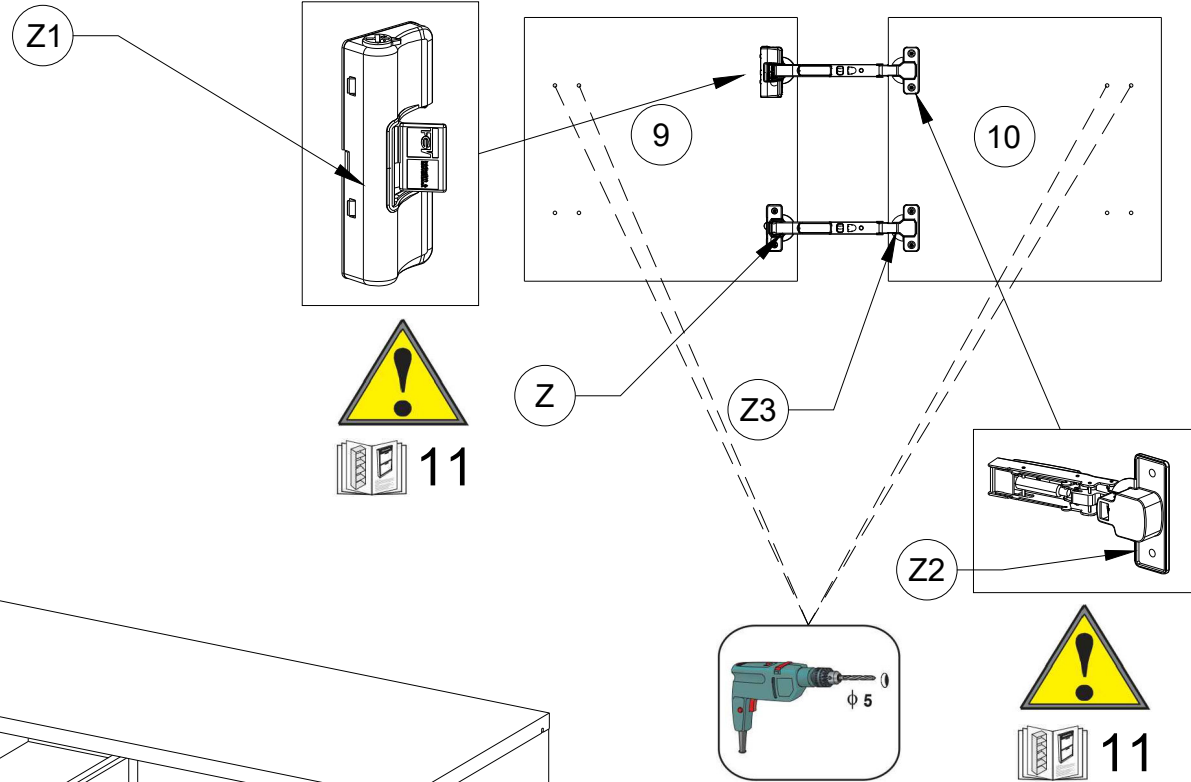
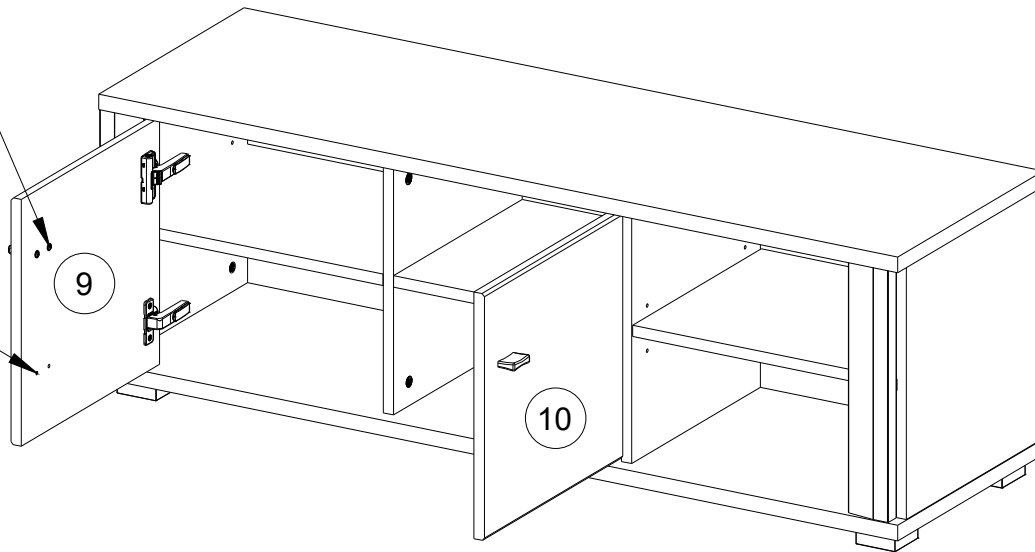
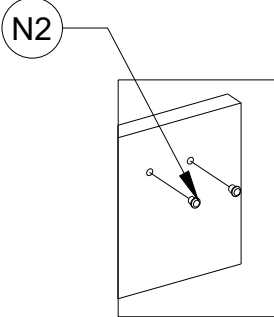
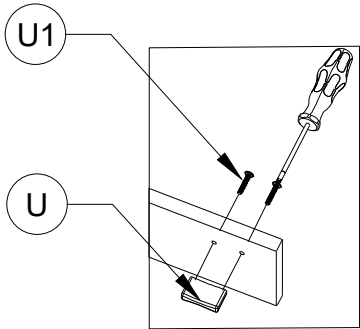

17

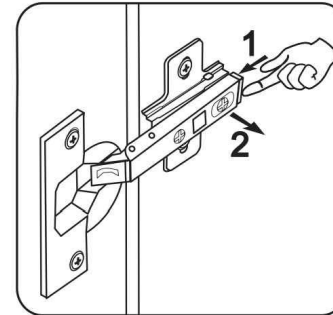
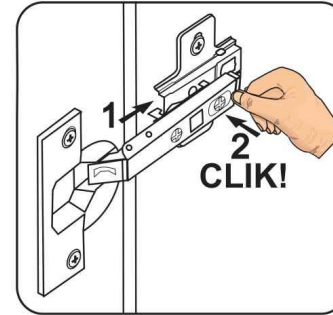
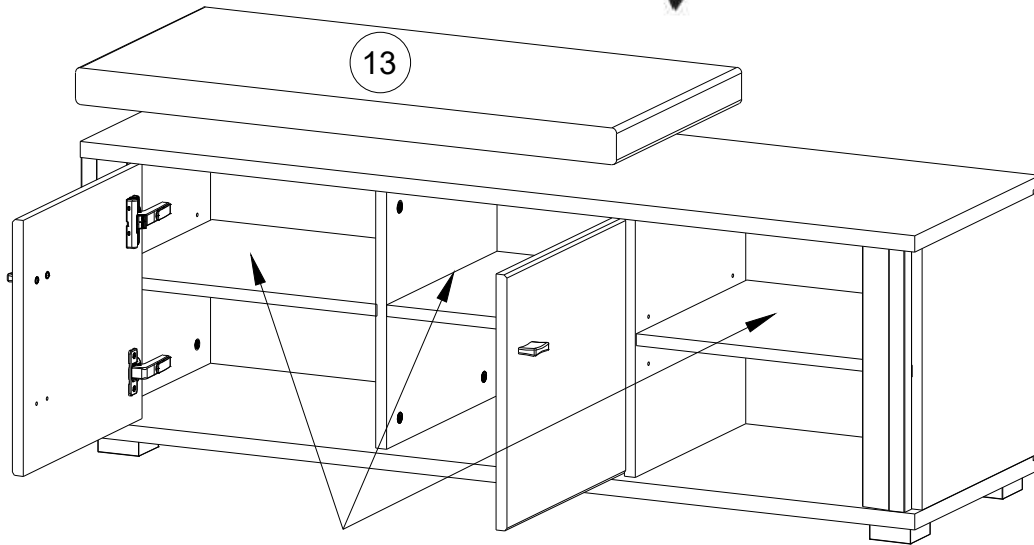
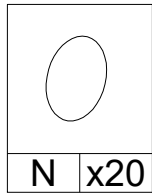

CLIK!

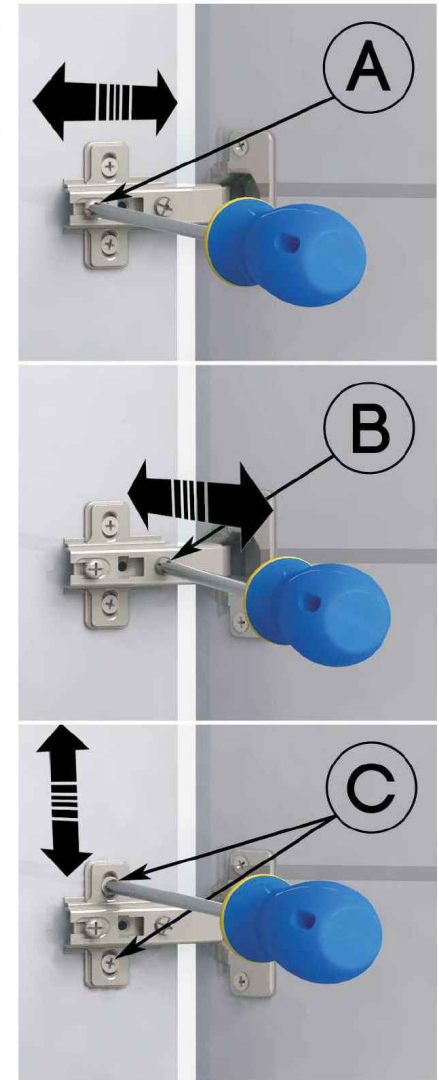
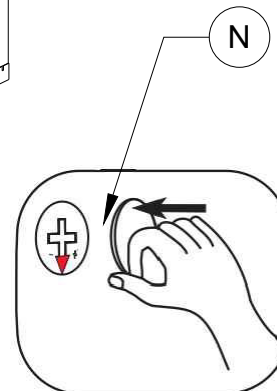

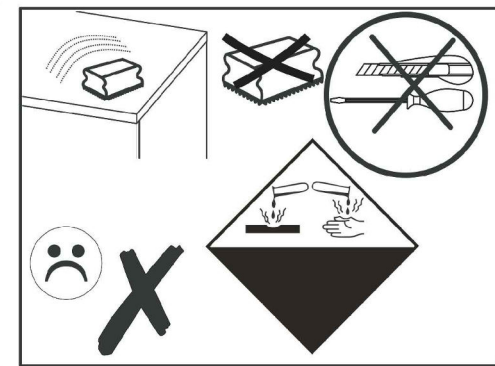
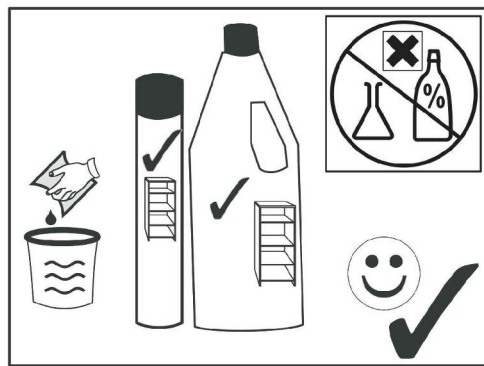
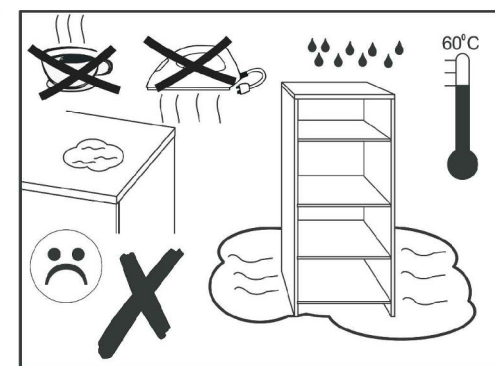
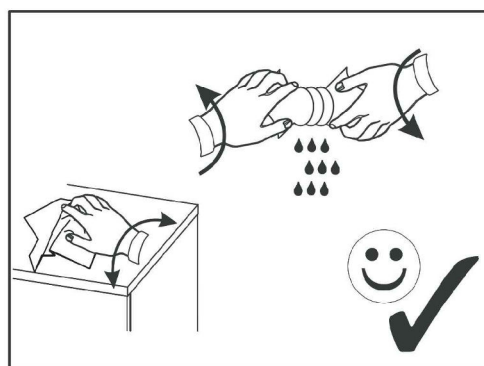
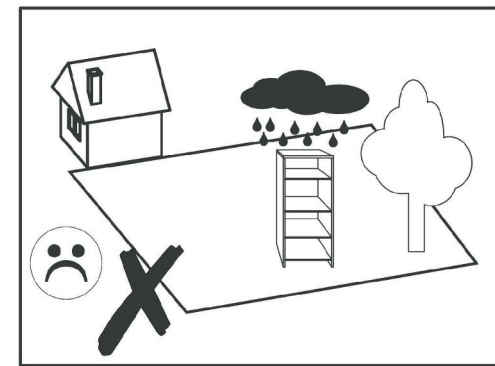
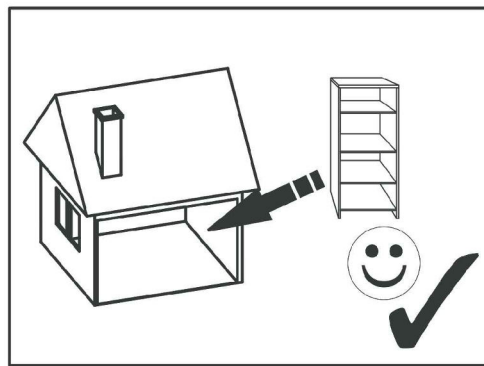
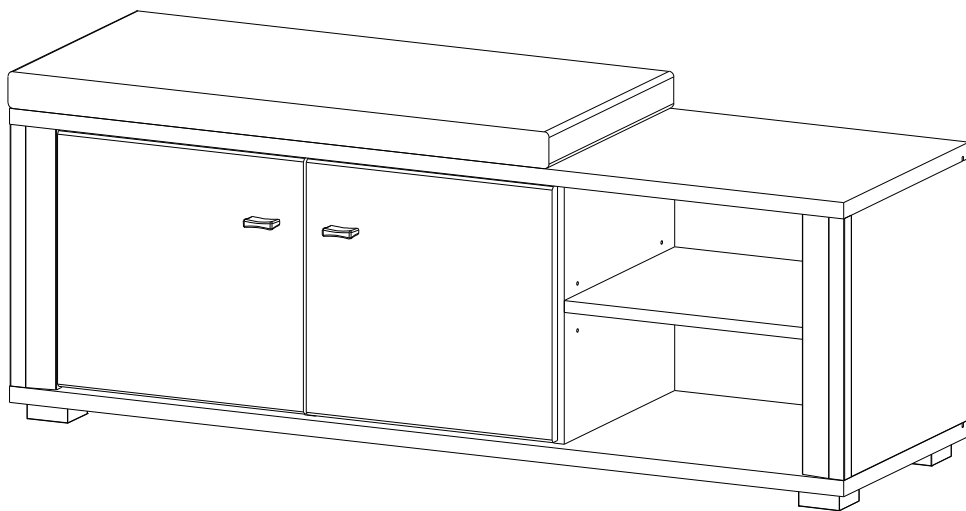

<b>D CH AT LI LU</b> <b>GB US</b> <b>FR BE NC</b> <b>NL</b> <b>IT</b> <b>SI</b> <b>XS HR BA</b> <b>HU</b> <b>BG</b> <b>CZ SK</b> <b>SE</b> <b>RO</b> <b>ES</b>	<p>Kleinstele und Verpackungstoffen bei der Möbelmontage von Kindern fernhalten!</p> <p>Keep small parts and plastic film out of the reach of children!</p> <p>Tenir les petites pièces et les films plastiques hors de la portée des enfants!</p> <p>Houd de kleine onderdelen en de plastic folie uit de buurt van kinderen!</p> <p>Tenere i componenti di piccole dimensioni e la pellicole di plastica fuori dalla portata dei bambini!</p> <p>Majstnih delov in embalažne folije pri montaži pohištva hranite izven dosega otrok!</p> <p>Mate dijelove i foliju za pakovanje priklom montaže namještaja držite dalje od djece!</p> <p>Büroszereles közbén a kis alkatrészek és a csomagoló fóliák gyermekkel távol tartandók!</p> <p>Дребни детайли и опаковъчни фолия да се държат далеч от деца при монтажа на мебелите!</p> <p>Pri montaži nabytku uchovávejte drobné díly a obalové fólie z dosahu dětí!</p> <p>Vid møbelmontering ska smadelar och förpackningsfolien hållas oåtkomliga för barn!</p> <p>Tineți departe de copii piesele mici și folia de ambalat la montarea mobiliei!</p> <p>¡Durante el montaje, mantenga alejados de los niños las piezas pequeñas y el material plástico de embalaje!</p>
<b>D CH AT LI LU</b> <b>GB US</b> <b>FR BE NC</b> <b>NL</b> <b>IT</b> <b>SI</b> <b>XS HR BA</b> <b>HU</b> <b>BG</b> <b>CZ SK</b> <b>SE</b> <b>RO</b> <b>ES</b>	<p>Möbelmontage muss auf ebenem Untergrund erfolgen. Bei Wandmontagen immer geeignetes Befestigungsmaterial verwenden.</p> <p>Furniture must be assembled on a flat surface. For assembly to the wall only use suitable fixing materials.</p> <p>Le meuble doit être monté sur une surface plane. Pour le montage mural, utilisez des accessoires de fixation adaptés au type de mur.</p> <p>De meubels dienen op een vlakke ondergrond te worden gemonteerd. Voor wandmontage moeten geschikte bevestigingsmaterialen worden gebruikt.</p> <p>Il montaggio dei mobili deve avvenire su un fondo piano. Per il montaggio si prega di utilizzare solo materiali adatti.</p> <p>Pohištvo je treba montirati na ravni podlagi. Pri stenski montaži vedno uporabite pritriljveni material.</p> <p>Namještaj se mora montirati na ravnoj podlozi. Kod montaže na zid uvijek koristite prikladan materijal za pričvršćivanje.</p> <p>A bútoraszerelest sük felületen kell végezni. Falra szereléshez mindig megfelelő rögzítanyagot kell használni.</p> <p>Монтажът на мебелите да се извършва на равна основа. При стънен монтаж винаги да се използва подходящ крепежен материал.</p> <p>Montáž nabytku provádějte na rovinném podkladu. Při montáži na stěnu používejte vždy vhodný příravnovací materiál.</p> <p>Montering av möbeln måste göras på jämnt underlag. Vid väggmontering ska lämpligt uppfästingsmaterial användas.</p> <p>Montarea mobiliei trebuie să se realizeze pe o pardoseală dreaptă. La montarea la perete utilizați întodeauna material de fixare adecvat.</p> <p>El montaje debe efectuarse sobre una superficie uniforme. En el montaje mural emplee siempre el material de fijación adecuado.</p>
<b>D CH AT LI LU</b> <b>GB US</b> <b>FR BE NC</b> <b>NL</b> <b>IT</b> <b>SI</b> <b>XS HR BA</b> <b>HU</b> <b>BG</b> <b>CZ SK</b> <b>SE</b> <b>RO</b> <b>ES</b>	<p>Bitte beachten Sie die Montageanleitung. Halten Sie immer die angegebene Wattzahl ein. Verhindern Sie einen Hitzezustand. Please observe the assembly instructions. Do not exceed the max. given wattage. Ensure that the heat is not allowed to build up. Veuillez respecter la notice de montage. Respectez impérativement le nombre des watts maximal. Veillez à éviter toute accumulation de chaleur.</p> <p>Lees a.u.b. de montagehandleiding door. Houd u deslist aan het max. opgegeven wattage. Zorg ervoor dat geen hitteopbouw ontstaat. Attenersi alle istruzioni di montaggio. Rispettarsi rigorosamente il numero di watt max. indicato. Assicurarsi che non si verifichi un accumulo di calore.</p> <p>Upoštevajte navodila za montažo. Vedno upoštevajte navedeno število vatov. Preprečite zastoj vročine.</p> <p>Obraťte miľno Vas pozor na uputú za montažu. Vždy se pridržavajte navedenog broja vati. Izbjegavajte zastoj vrućine.</p> <p>Всегда соблюдайте мощность и соблюдайте правила монтажа. Всегда соблюдайте указанную мощность. Избегайте аккумуляции на топлицы.</p> <p>Dodržujte prosim navod k montaži. Vždy dodržujte uvedenou hodnotu výkonu (watt). Zabráňte tak přehřívání.</p> <p>Főli montírsanvisningén. Főli alildt angivel wattal. Udvik att hetta uppstår.</p> <p>Respectați instrucțiunile de montaj. Respectați întodeauna numărul de wați impus. Evitați acumularea de căldură.</p> <p>Le togamos que tenga presente las instrucciones de montaje. Respete siempre el número indicado de vatios. Evite la acumulación de calor.</p>
<b>D CH AT LI LU</b> <b>GB US</b> <b>FR BE NC</b> <b>NL</b> <b>IT</b> <b>SI</b> <b>XS HR BA</b> <b>HU</b> <b>BG</b> <b>CZ SK</b> <b>SE</b> <b>RO</b> <b>ES</b>	<p>Halten Sie die max. zulässigen Belastungswerte der Möbelteile ein. Details siehe Montageanleitung</p> <p>Comply with the max. permissible loads. For details, please refer to the assembly instructions</p> <p>Respectez les valeurs de charge max. admissibles des parties de meubles. Pour plus de détails, cf. la notice de</p> <p>Houd de maximaal geoorloofde belastingwaarden van de meubeldelen aan. Voor details verwijzen wij naar de montagehandleiding</p> <p>Rispettare la portata max. permessa degli elementi del mobile. Per dettagli si vedano le istruzioni di montaggio e si vada</p> <p>Upoštevajte največje dovoljeno obremenitve delov pohištva. Podrobnosti najdete v navodilih za montažo in na</p> <p>Pridržavajte se maks. Dozvoljenih vrijednosti opterećenja elemenata namještaja. Detalje vidj u uputi za montažu</p> <p>Tartsa be a bútorelemek max. megengedett terhelési értékeit. A részleteket lásd a szerelési útmutatóban</p> <p>Спазвайте макс. допустимите стокности на частите на мебелите. За подробности виж ръководството за монтаж</p> <p>Dodržujte max. přípustné hodnoty zatížení nábytkových dílů. Podrobnosti viz návod k montáži</p> <p>Főli max. tilálatlan beárlásning av möbeldelana. Mer íformátion finni í monteringsanvisningun</p> <p>Respectați valorile de solicitare max. admise pentru corpurile de mobilier. Pentru detalii consultați instrucțiunile de montaj</p> <p>Respete los valores máximos de carga admisibles para las piezas de los muebles. Consulte los detalles en las instrucciones</p>
<b>D CH AT LI LU</b> <b>GB US</b> <b>FR BE NC</b> <b>NL</b> <b>IT</b> <b>SI</b> <b>XS HR BA</b> <b>HU</b> <b>BG</b> <b>CZ SK</b> <b>SE</b> <b>RO</b> <b>ES</b>	<p>Zur Möbelerichtung ein mit Wasser befeuchtetes, fusselfreies Baumwolltuch verwenden. Gereinigte Flächen immer trockenreiben!</p> <p>To clean the furniture only use a water dampened lint-free cotton cloth. Once cleaned, always wipe the surfaces dry.</p> <p>Utilisez un chiffon en coton non pelucheux humidifié avec de l'eau pour nettoyer les meubles. Séchez systématiquement les surfaces nettoyées en les frottant!</p> <p>Gebruik een met water bevochtigde, pluistvrije katoenen doek om de meubels te reinigen. Wrijf gereinigde oppervlakken altijd droog!</p> <p>Per pulire il mobile utilizzare un panno di cotone inumidito da acqua e che non perde pelucchi. Asciugare sempre le superfici che si sono pulite!</p> <p>Za čišćenje pohištva uporabljajte vlažno bombažno krpo, ki ne pušča vlaken. Očiščene površine vedno obrišite do suhlega!</p> <p>Za čišćenje namještaja koristite sa vodom navlaženu ramušnu krpu koja ne ispušta vlakna. Očišćene površine uvijek obrišite suhom krpom!</p> <p>Bútorírálláshoz vízzel be nedvesített, nem szállázódó pamukkenet használjon. A megírástólól felületeket mindig törőlje szárazra!</p> <p>За почистване на мебелите използвайте навлажнена с вода, неиспушваща влакна памучна кърпа. Почиствените повърхности винаги да се изтриват до сухи!</p> <p>K čišćení nabytku používejte navlžený hadr neuvolňující vlákna, navlhčenu ve vodě. Využívané plochy vždy utřete do sucha!</p> <p>För möbelerättning används en luddfri bomullsduk fuktad med vatten. Rengörda ytor ska alltid torkas torra!</p> <p>Pentru curățarea mobiliei utilizați o lavetă din bumbac fără scame umezită cu apă. Suprafețele curățate se șterg întodeauna până se usucă!</p> <p>Empiee un paño de algodón humedecido con agua y líbre de pelusa para la limpieza de los muebles. ¡Seque siempre las superficies que ha limpiado!</p>

# PABLO 30-H5HG-61