

Modellname:  
Nazwa modelu:

**Nature Plus**

Modellreihe:  
Numer modelu: **3205FF40**

Type: **40**  
Typ:

Blatt Nr **1** von: **3**  
Strona **1** z: **3**

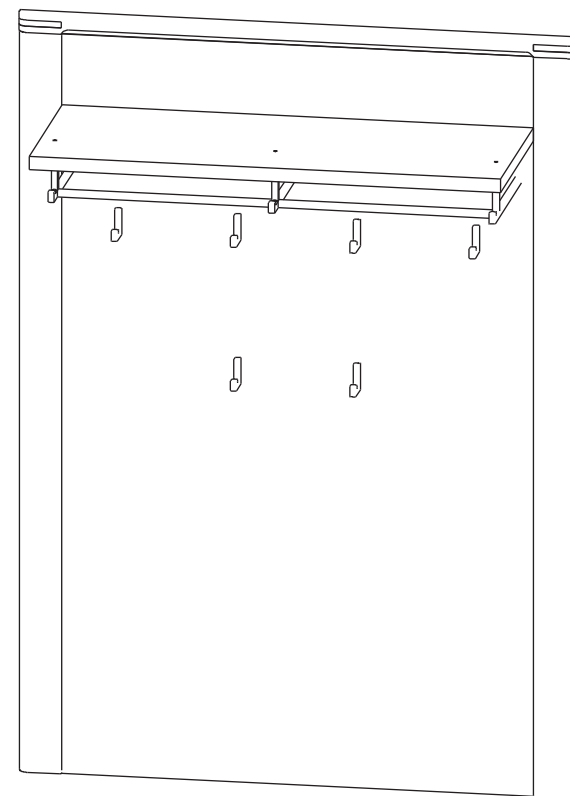
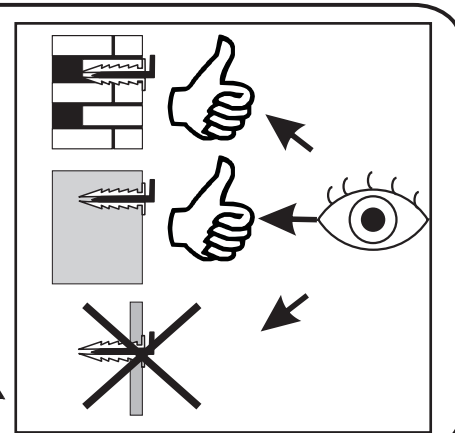
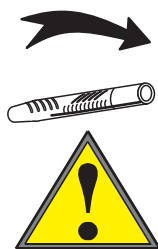
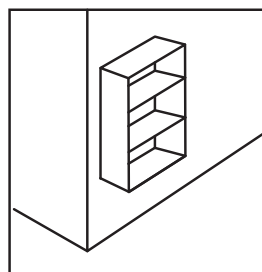
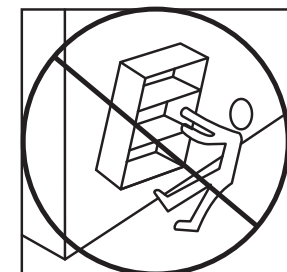
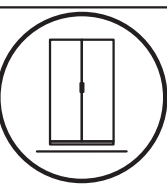
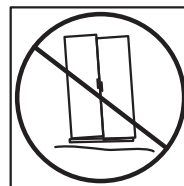
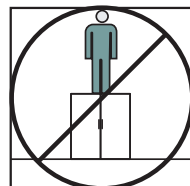
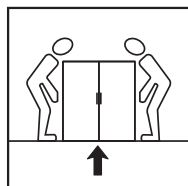
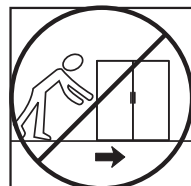
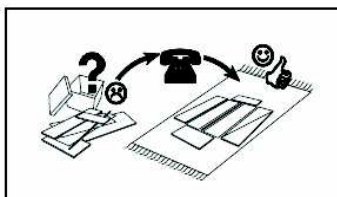
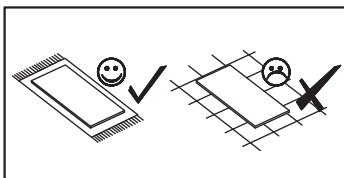
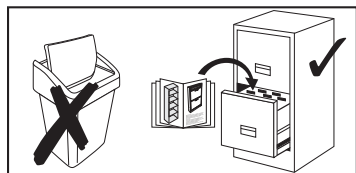
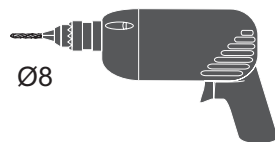
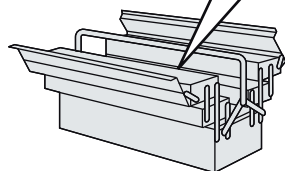
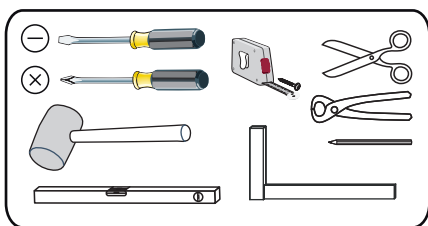
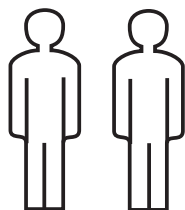

Modellname: **Nature Plus**  
 Nazwa modelu:

Modellreihe: **3205FF40**  
 Numer modelu:

Type: **40**  
 Typ:

Blatt Nr **2** von: **3**  
 Strona **2** z: **3**

B - 900 mm  
 H - 1600 mm  
 T - 315 mm

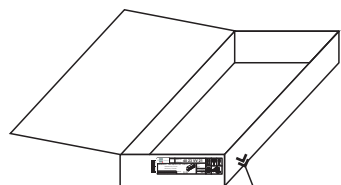
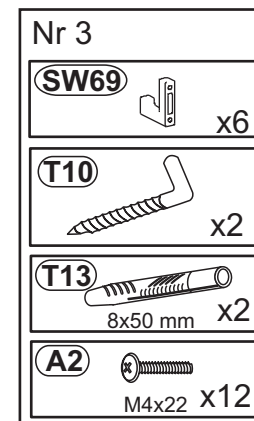
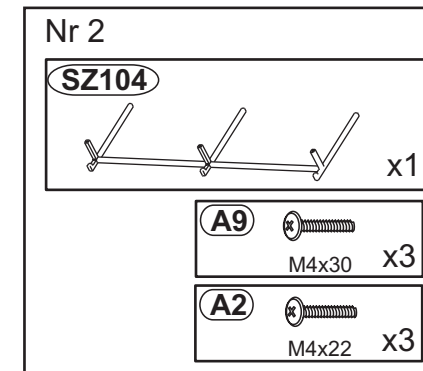
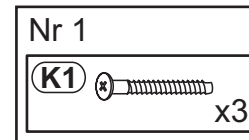
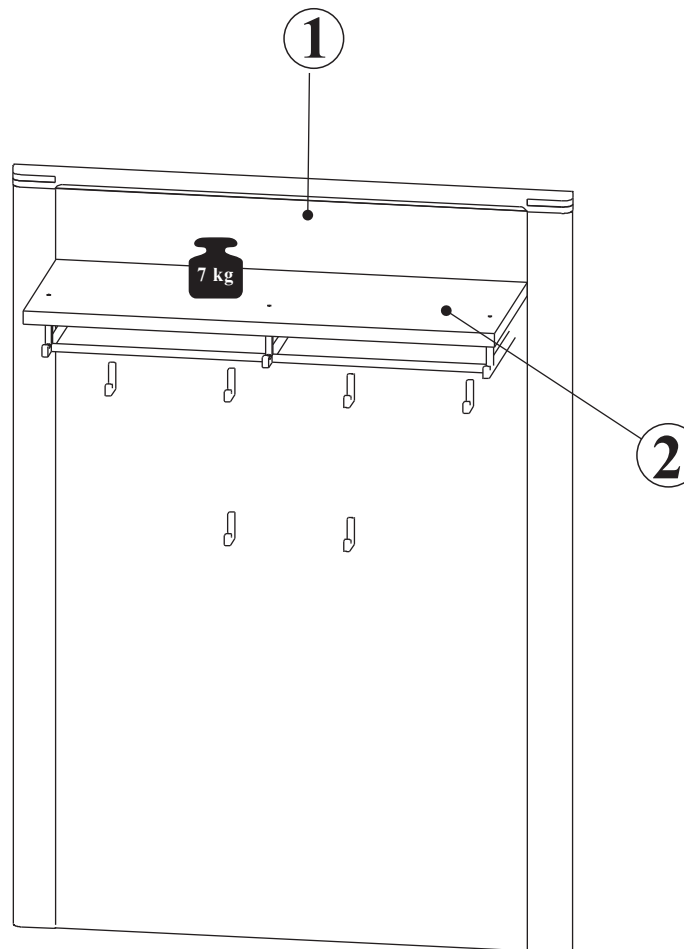
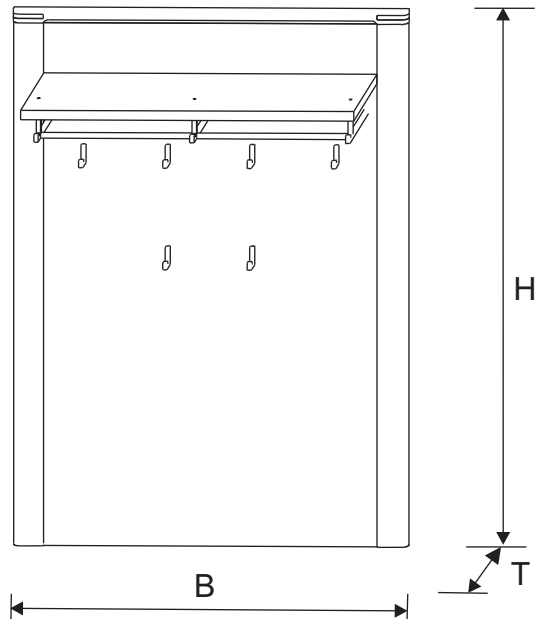

1	900	1600	1	1/1
2	758	300	1	1/1



Modellname:  
Nazwa modelu:

# Nature Plus

Modellreihe:  
Numer modelu:

## 3205FF40

Type:  
Typ:

## 40

Blatt Nr  
Strona

von:  
z:

# 1

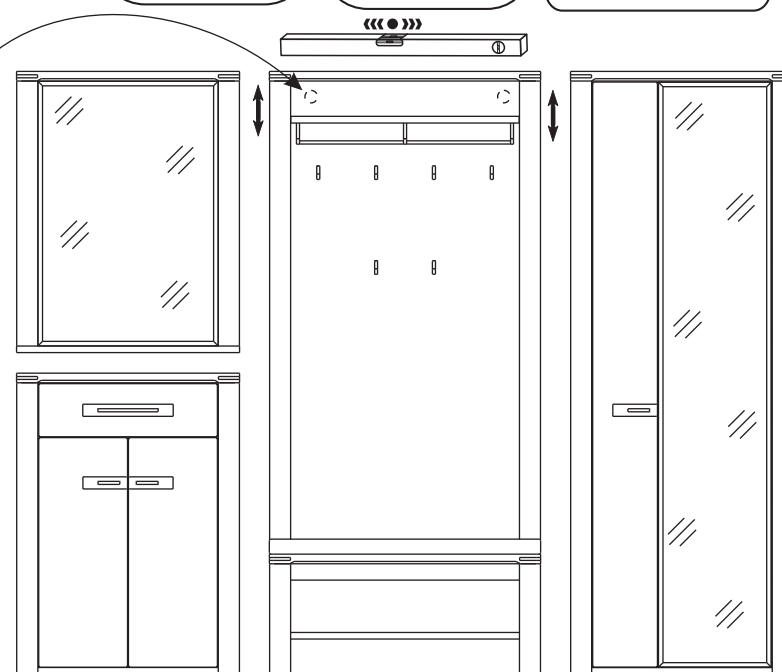
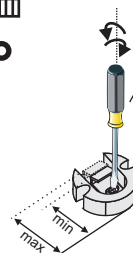
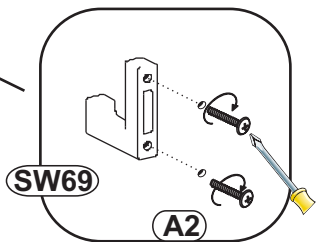
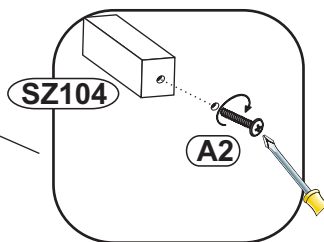
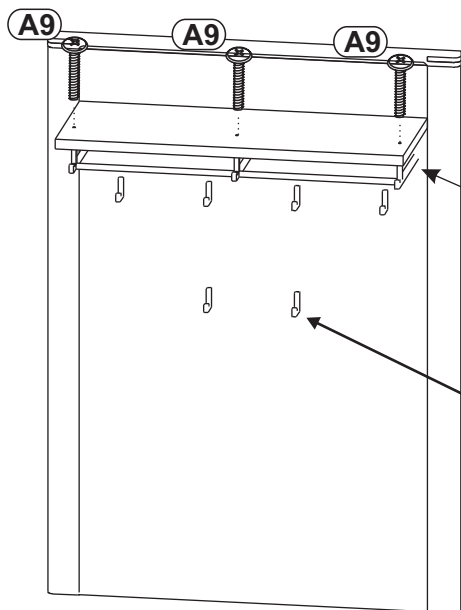
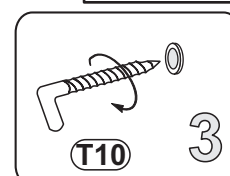
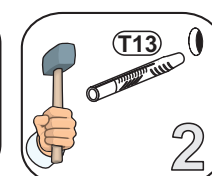
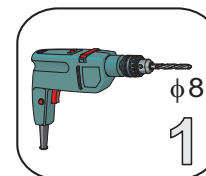
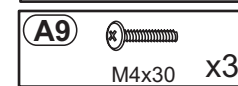
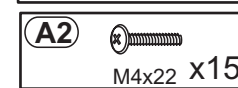
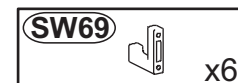
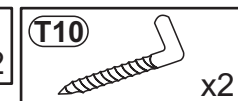
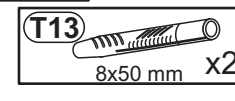
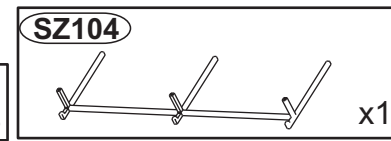
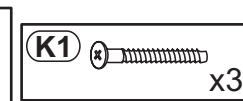
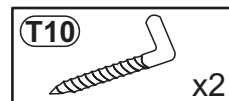
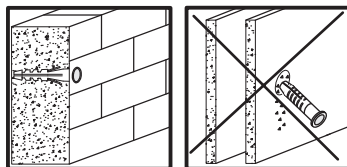
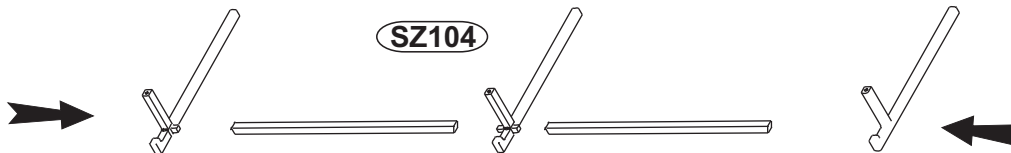
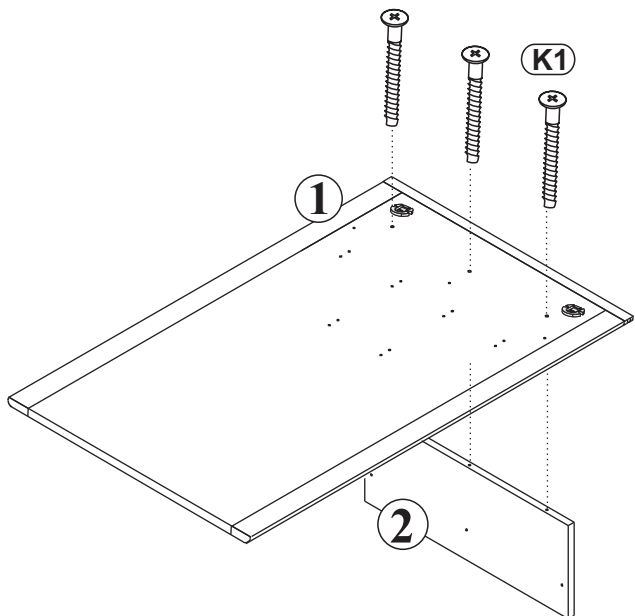

**D CH AT LI LU** Kleinstele und Verpackungsfolien bei der Möbelmontage von Kindern fernhalten!  
**GB US** Keep small parts and plastic film out of the reach of children!  
**FR BE NC** Tenir les petites pièces et les films plastiques hors de la portée des enfants!  
**NL** Hou de kleine onderdelen en de plastic folie uit de buurt van kinderen!  
**IT** Tenere i componenti di piccole dimensioni e le pellicole di plastica fuori dalla portata dei bambini!  
**SI** Malhni delov i foliju za pakovanje priklom montaži pohištna priane izven dosega otrok!  
**XS HR BA** Mahe dijelove i foliju za pakovanje priklom montaže namještaja držite dalje od djece  
**HU** Bútorészeket közbden a kis alkatrészek és a csomagoló fóliák gyerekekkel távol tartandók!  
**BG** Дребни детайли и опаковъчни фолиа да се държат далеч от деца при монтажа на мебелите!  
**CZ SK** Vid montáži nábytku uchovávejte drobné díly a obalové fólie z dosahu dětí!  
**SE** Vid möbelföringen ska smådelar och förpackningsfolien hållas oåtkomliga för barn!  
**RO** Țineți departe de copil piesele mici și folia de ambalat la montarea mobiliei!  
**ES** ¡Durante el montaje, mantenga alejados de los niños las piezas pequeñas y el material plástico de embalaje!

**D CH AT LI LU** Möbelmontage muss auf ebennem Untergrund erfolgen. Bei Wandmontagen immer geeignetes Befestigungsmaterial verwenden.  
**GB US** Furniture must be assembled on a flat surface. For assembly to the wall only use suitable fixing materials.  
**FR BE NC** Le meuble doit être monté sur une surface plane. Pour le montage mural, utilisez des accessoires de fixation adaptés au type de mur.  
**NL** De meubels dienen op een vlakke ondergrond te worden gemonteerd. Voor wandmontage moeten geschikte bevestigingsmaterialen worden gebruikt.  
**IT** Il montaggio dei mobili deve avvenire su un fondo piano. Per il montaggio si prega di utilizzare solo materiali adatti.  
**SI** Pohištvo je treba montirati na ravni podlagi. Pri stenski montaži vedno uporabite pritrilveni material.  
**XS HR BA** Namještaj se mora montirati na ravnoj podlozi. Kod montaže na zid uvijek koristite prikladan materijal za pričvršćivanje.  
**HU** A bútorcszerelési silk felületen kell végezni. Falra szereléshez mindig megfelelő rögzítianyagot kell használni.  
**BG** Монтажът на мебелите да се извършва на равна основа. При стенен монтаж винаги да се използва подходящ крепежен материал.  
**CZ SK** Montáž nábytku provádějte na rovném podkladu. Při montáži na stěnu používejte vždy vhodný příslušenací materiál.  
**SE** Monteringen av möbeln måste göras på jämnt underlag. Vid väggmontering ska lämpligt uppfästingsmaterial användas.  
**RO** Montarea mobiliei trebuie să se realizeze pe o pardoseală dreaptă. La montarea la perete utilizați întotdeauna material de fixare adecvat.  
**ES** El montaje debe efectuarse sobre una superficie uniforme. En el montaje mural emplee siempre el material de fijación adecuado.

**D CH AT LI LU** Bitte beachten Sie die Montageanleitung. Halten Sie immer die angegebene Wattzahl ein. Verhindern Sie einen Hitzestau.  
**GB US** Please observe the assembly instructions. Do not exceed the max. given wattage. Ensure that the heat is not allowed to build up.  
**FR BE NC** Veuillez respecter la notice de montage. Respectez impérativement le nombre des watts maximal. Veillez à éviter toute accumulation de chaleur.  
**NL** Lees a.u.b. de montagehandleiding door. Hou de beslist aan het max. opgegeven wattage. Zorg ervoor dat geen hittehuwling onstaat.  
**IT** Attenersi alle istruzioni di montaggio. Rispettarsi rigorosamente il numero di watt max. indicato. Assicurarsi che non si verifichi un accumolo di calore.  
**SI** Upoštevajte navodila za montažo. Vedno upoštevajte navedeno število vatov. Preprečite zastoj vročine.  
**XS HR BA** Obratite pažnju! Vas pozor na uputu za montažu. Uvijek se pridržavajte navedenog broja vai. Izbjegavajte zastoj vrućine.  
**HU** Vegye figyelembe a szerelési útmutatót. Mindig tartsa be a megadott wattszámot. Akadályozza meg a hőelődést.  
**BG** Моля, вземете под внимание ръководството за монтаж. Спазвайте винаги посочените ватове. Избягвайте акумулиране на топлина.  
**CZ SK** Dodržujte prosím návod k montáži. Vždy dodržujte uvedenou hodnotu výkonu (watt). Zabráňte tak přehřívání.  
**SE** Följ monteringsanvisningen. Följ alltid angivet watttal. Undvik att hetta uppstår.  
**RO** Respectați instrucțiunile de montaj. Respectați întotdeauna numărul de watt impus. Evitați acumularea de căldură.  
**ES** Le rogamos que tenga presente las instrucciones de montaje. Respete siempre el número indicado de vatios. Evite la acumulación de calor.

**D CH AT LI LU** Halten Sie die max. zulässigen Belastungswerte der Möbelteile ein. Details siehe Montageanleitung  
**GB US** Comply with the max. permissible loads. For details, please refer to the assembly instructions  
**FR BE NC** Respectez les valeurs de charge max. admissibles des parties de meubles. Pour plus de détails, cf. la notice de  
**NL** Hou de maximaal geoorloofde belastingwaarden van de meubeldelen aan. Voor details verwijzen wij naar de montagehandleiding  
**IT** Rispettare la portata max. permessa degli elementi del mobile. Per dettagli si vedano le istruzioni di montaggio e si vada  
**SI** Upoštevajte največjo dovoljeno obremenitev delov pohištna. Podrobnosti najdete v navodilih za montažo in na  
**XS HR BA** Tartsa be a bútorelemek max. megengedett terhelési értékét. A részleteket lásd a szerelési útmutatóban  
**HU** Snaazaita max. dopustimite stoinosti na natovaravne na mebelite. Za podrobnosti vjv rýkovodstvoto za montaz  
**BG** Dodržujte max. přípustné hodnoty zatížení nábykových dílů. Podrobnosti viz návod k montáži  
**CZ SK** Fólj máx. tilátlen belasting av möbeldelarna. Mer information finns i monteringsanvisningen  
**SE** Respektati valoite de solicitare max. admise pentru corpurile de mobilier. Pentru detalii consultați instrucțiunile de montaj  
**RO** Respecte los valores máximos de carga admisibles para las piezas de los muebles. Consulte los detalles en las instrucciones  
**ES**

**D CH AT LI LU** Zur Möbelfeinigung ein mit Wasser befeuchtetes, fusselfreies Baumwolltuch verwenden. Geeignigte Flächen immer trockenreiben!  
**GB US** To clean the furniture only use a water dampened lint-free cotton cloth. Once cleaned, always wipe the surfaces dry.  
**FR BE NC** Utilisez un chiffon en coton non pelucheux humidifié avec de l'eau pour nettoyer les meubles. Séchez systématiquement les surfaces  
**NL** nettoeës en les frotlanti!  
**IT** Gebuik een met water bevochtigde, pluivrije katoenen doek om de meubels te reinigen. Wrijf gereinigde oppervlakken altijd droog!  
**SI** Per pulire il mobile utilizzare un panno di cotone inumidito d'acqua e che non perde pelucchi. Asciugare sempre le superfici che si sono  
**XS HR BA** kromi!  
**HU** Za čišćenje pohištva uporabljajte vlažno bombažno krpo, ki ne pušča vlaken. Očišćene površine vedno obrišite do suhnega!  
**BG** Za čišćenje namještaja koristite sa vodom navlaženu pamučnu krpu koja ne ispušta vlakna. Očišćene površine uvijek obrišite suhom  
**CZ SK** K čištění nábytku používejte bavlněný hadr neuvloňující vlákna, navlhčený ve vodě. Učištěné plochy vždy utřete do sucha!  
**SE** För möbelföring används en luddfri bomullsduk fuktad med vatten. Rengjorda ytor ska alltid torkas torra!  
**RO** Pentru curățarea mobiliei utilizați o lavetă din bumbac fără scame umezită cu apă. Suprafețele curățate se șterg întotdeauna până se usucă!  
**ES** Emplee un paño de algodón humedecido con agua y libre de pelusa para la limpieza de los muebles. ¡Seque siempre las superficies que ha limpiado!