







1	S507-1003	1210	340	1/1
2	S507-1004	1210	340	1/1
3	S507-2003	400	363	1/1
4	S507-3005	367	320	1/1
5	S507-3006	367	320	1/1
6	S507-3007	366	310	1/1
7	S507-7003	736	396	1/1
8	S507-7004	241	396	1/1
9	S507-7802	255,	396,	1/1
10	S507-9003	715	377	1/1
11	S507-9004	282	377	1/1
12	S507-9005	221	377	1/1





3x  a158	1x  a133	3x  b82
1x  96mm c418	4x  Ø5x17 mm d1	16x  Ø8x30 mm f1
2x  M4x25 mm j8	8x  l2	6x  20x13x3,5 n108
1x  n216/L	1x  n216/P	4x  Ø4x30 mm p21
6x  Ø3,5x15 mm p51	6x  Ø2,9x16 mm p55	2x  Ø2x8 mm p123
8x  Ø4x50 mm p150	16x  Ø15x12 mm #16 r1	16x  20/11 r42
16x  Ø 20mm s68	3x  Ø35x62x40x10 s71	
1x  o86/1	1x  o86/2	1x  o80/3
		1x  o80/12
4x  Ø10x50 mm f35	2x  n217	4x  Ø5x60 mm p17

1x  o86/1	1x  o86/2	1x  o80/3	1x  o80/12
-----------------	-----------------	-----------------	------------------

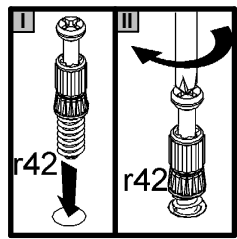
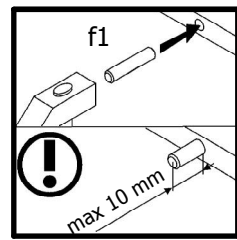
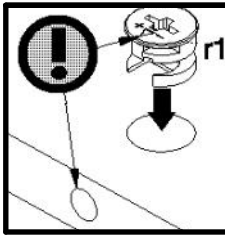
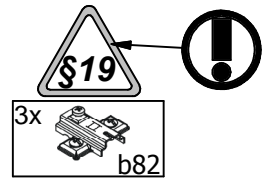
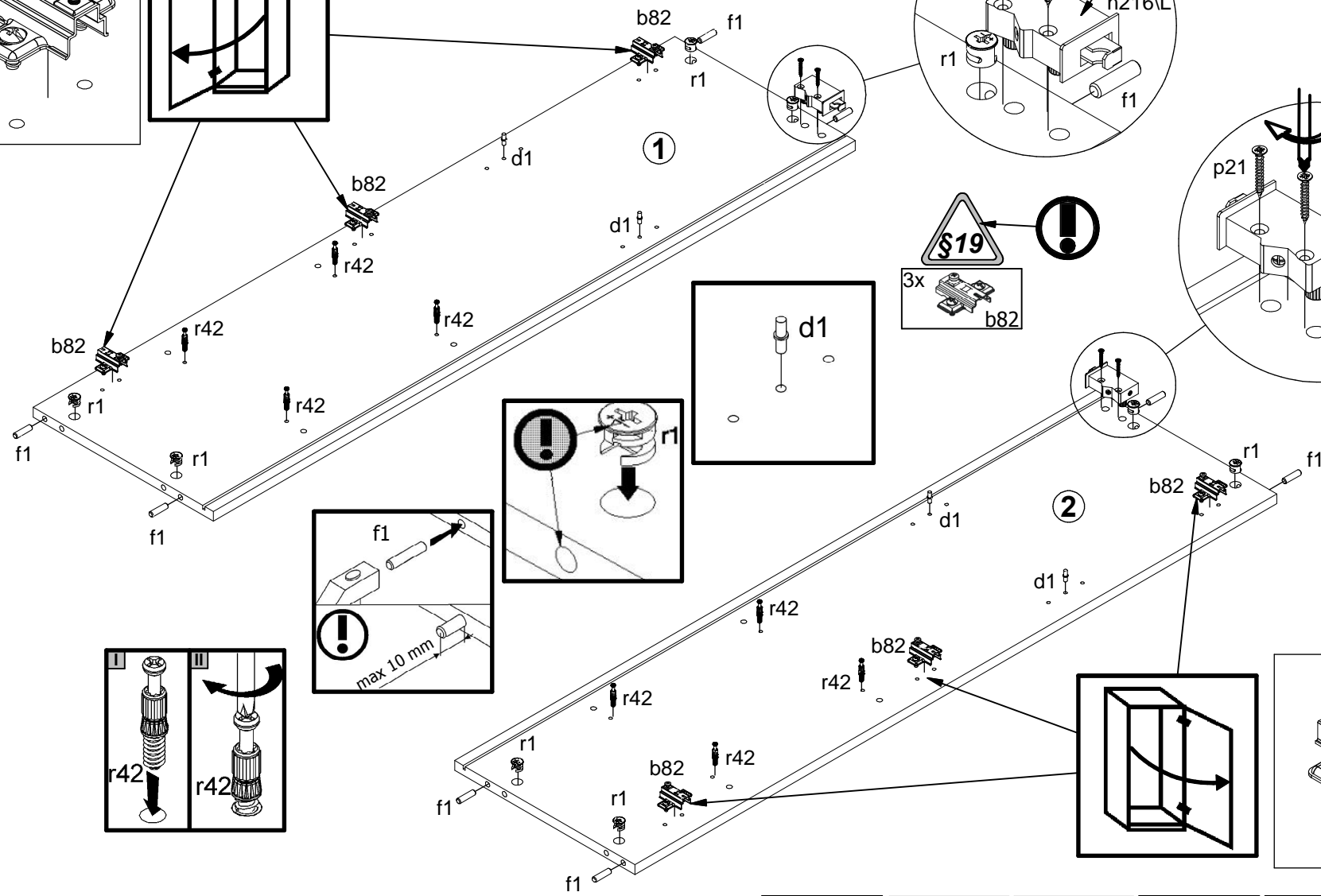
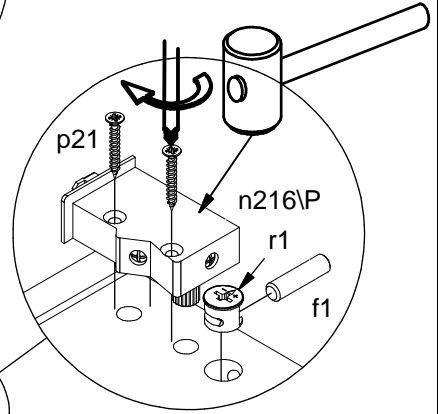
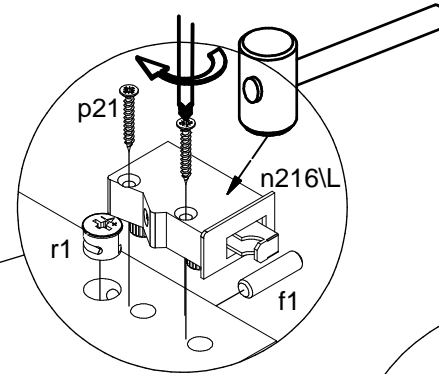
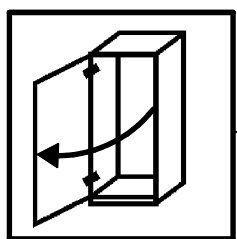
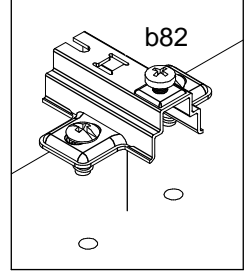

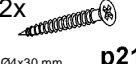
- 2x  d1  $\varnothing 5 \times 17 \text{ mm}$
- 4x  r1  $\varnothing 15 \times 12 \text{ mm} \#16$
- 4x  f1  $\varnothing 8 \times 30 \text{ mm}$
- 1x  n216L
- 2x  p21  $\varnothing 4 \times 30 \text{ mm}$
- 4x  r42  $\varnothing 4 \times 30 \text{ mm}$

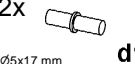

- 4x  r42  $\varnothing 4 \times 30 \text{ mm}$
- 2x  p21  $\varnothing 4 \times 30 \text{ mm}$
- 1x  n216P
- 2x  d1  $\varnothing 5 \times 17 \text{ mm}$
- 4x  r1  $\varnothing 15 \times 12 \text{ mm} \#16$
- 4x  f1  $\varnothing 8 \times 30 \text{ mm}$

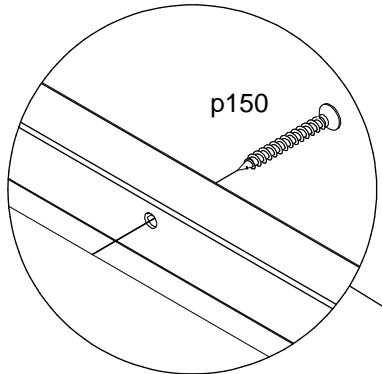
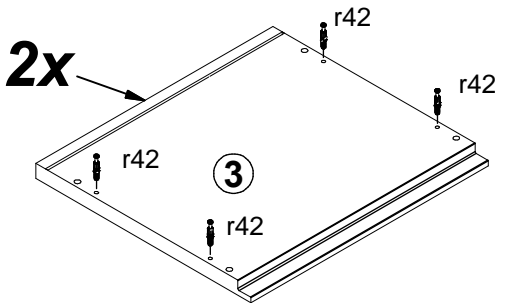
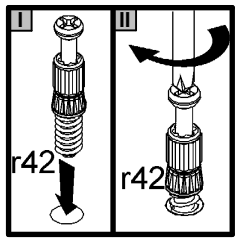

1

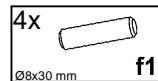
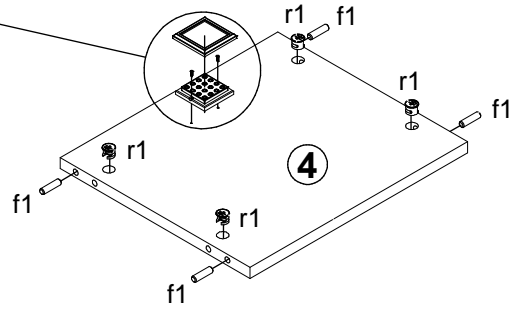
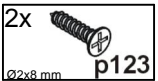
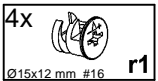
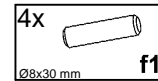
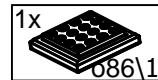
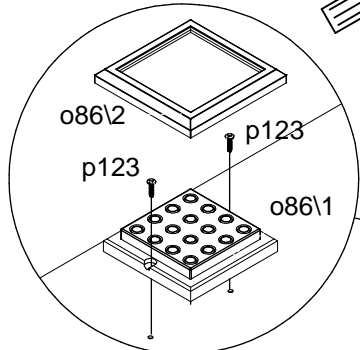
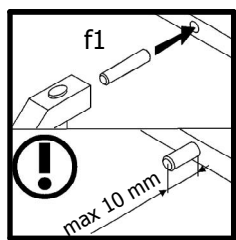
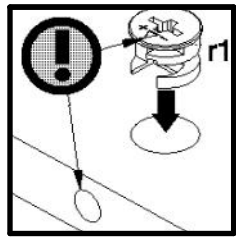
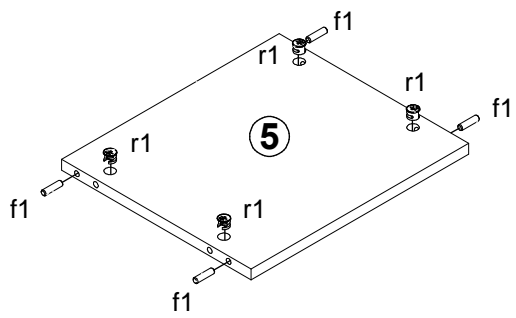
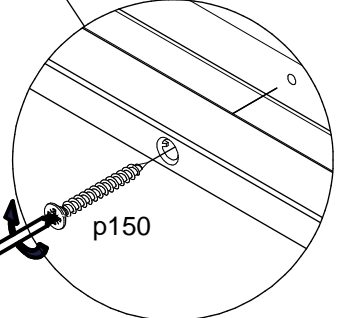
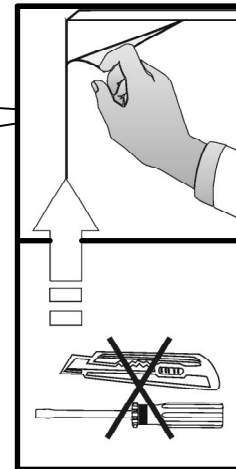
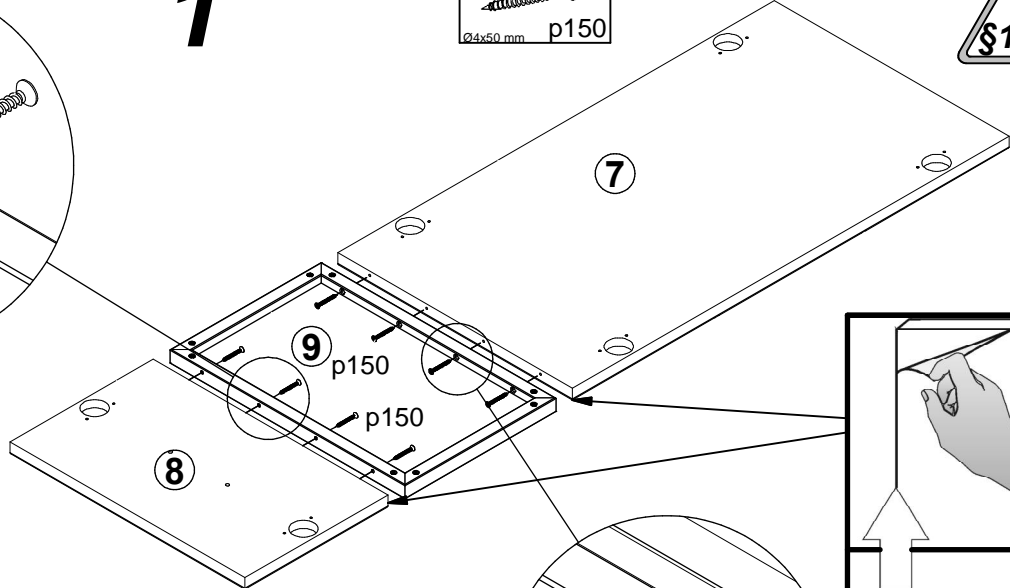
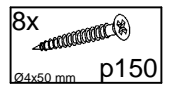

A

S507-SFW1W/13/4



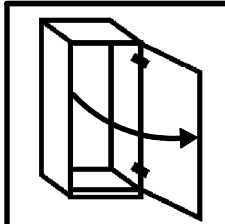

10 H9 -- 10

5 / 9

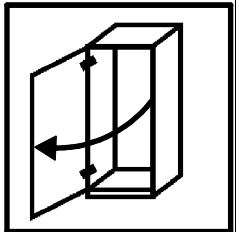
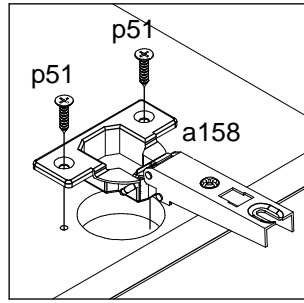
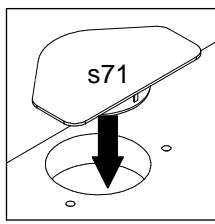
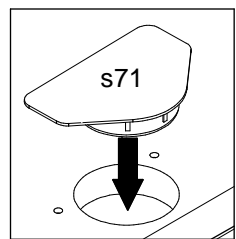
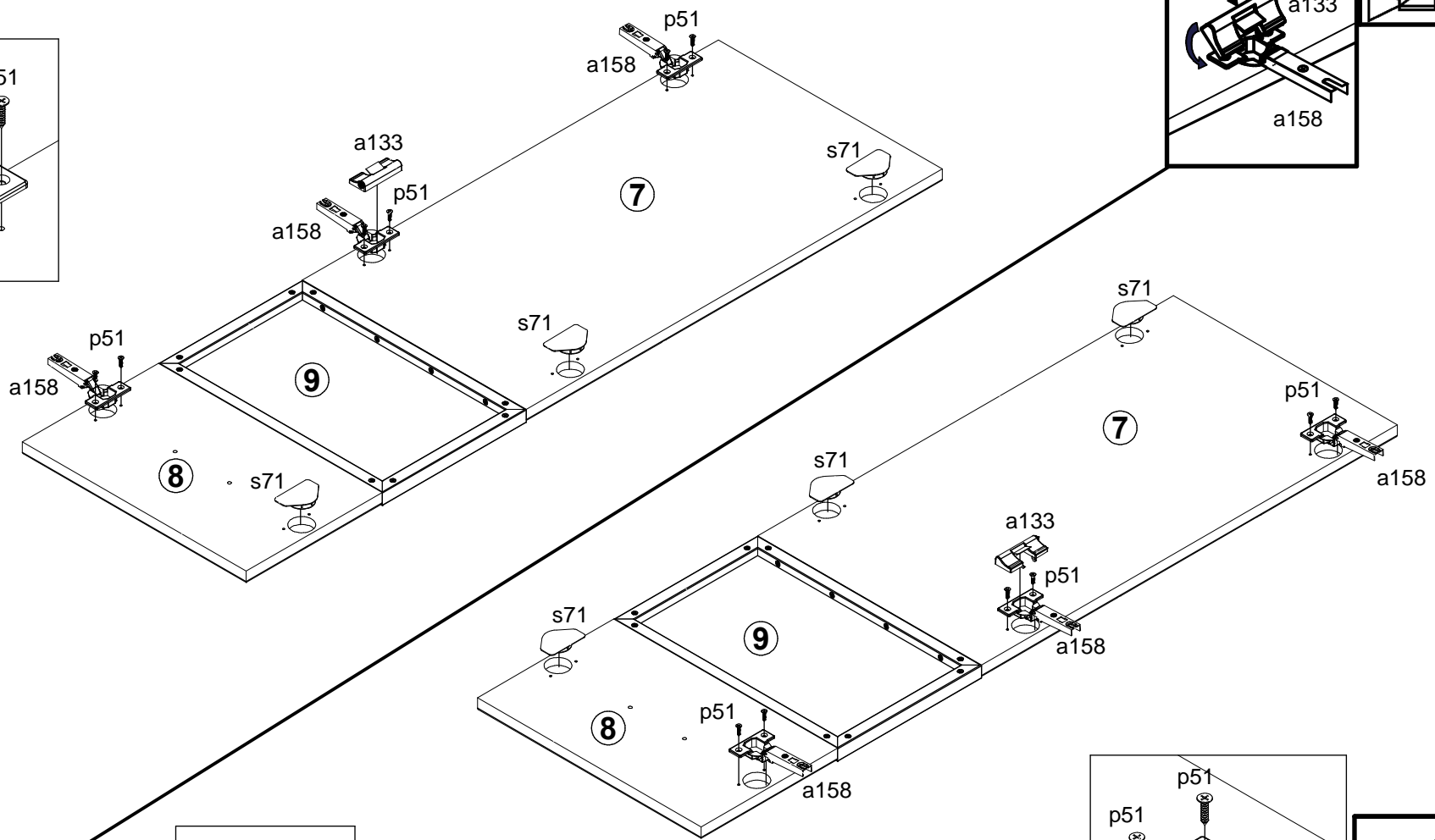
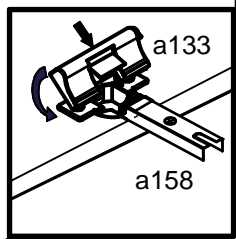
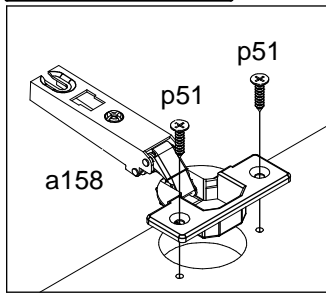
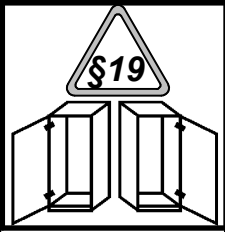

1



- 3x  a158
- 1x  a133
- 6x  p51
- 3x  s71

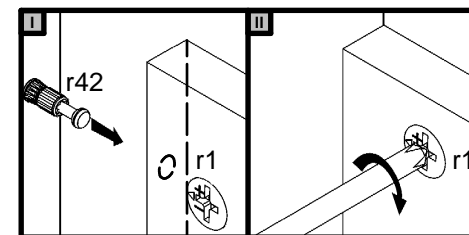
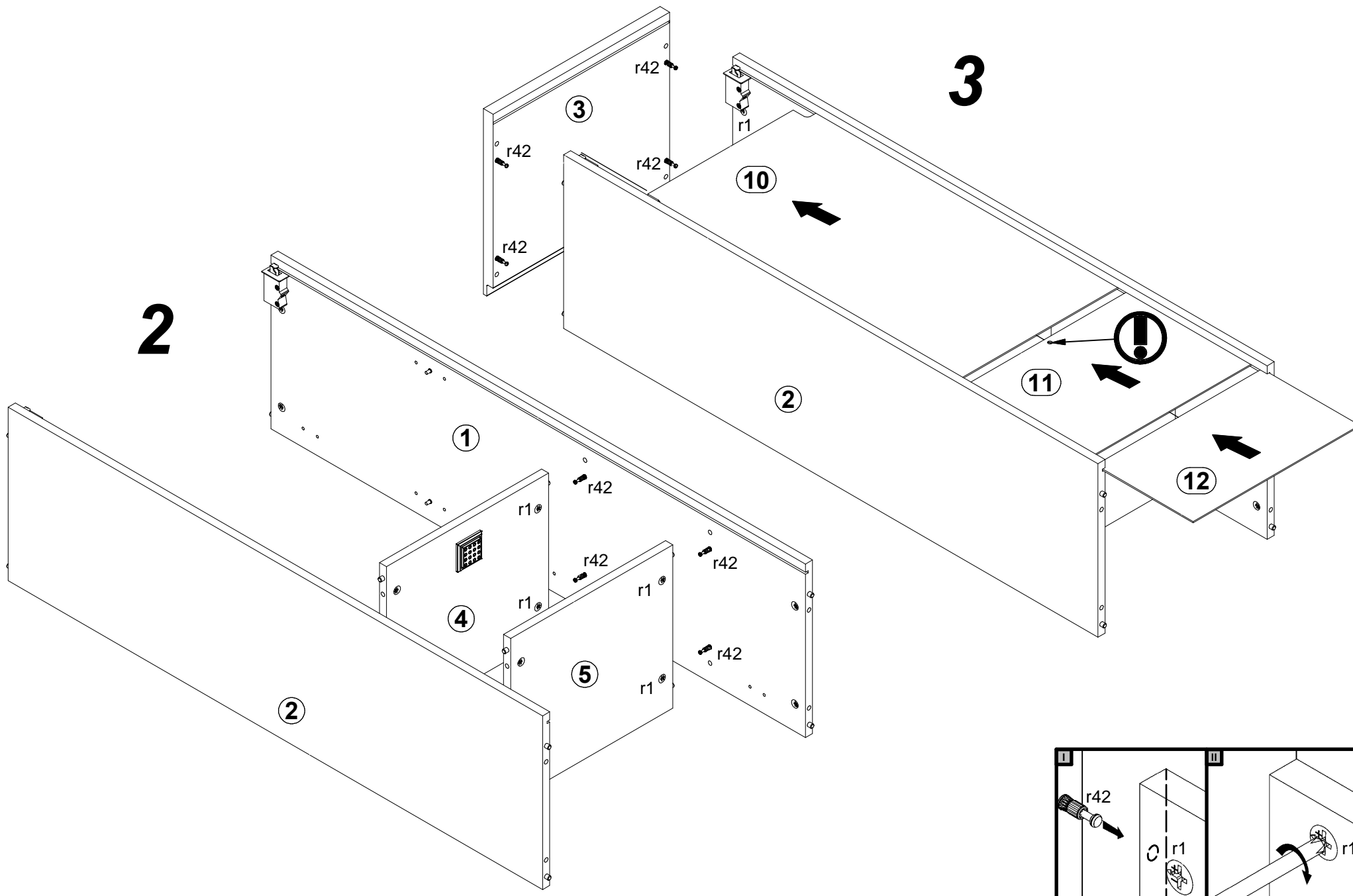

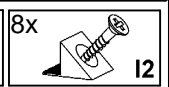
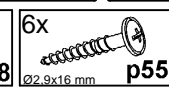
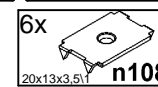
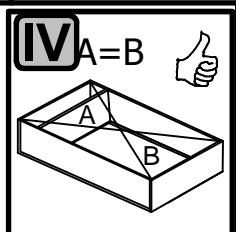
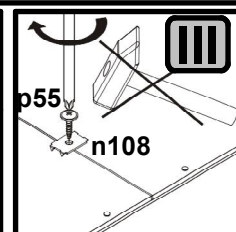
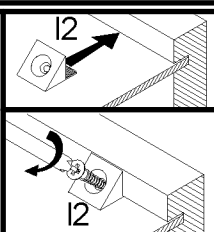
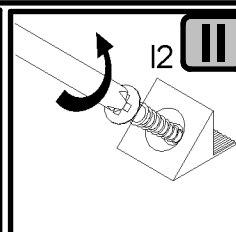
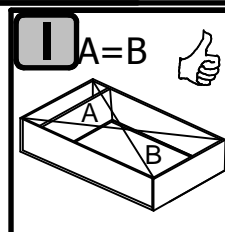

4

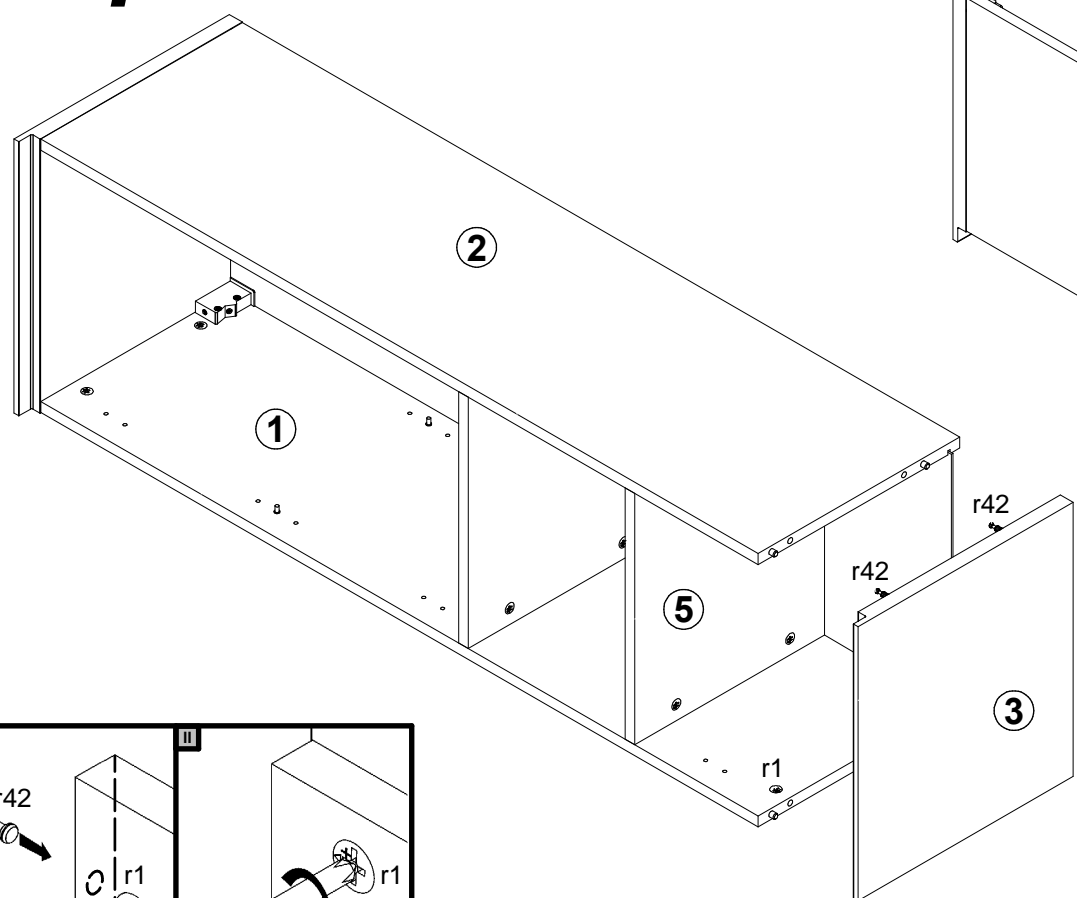

5

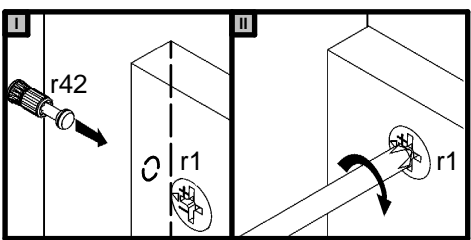
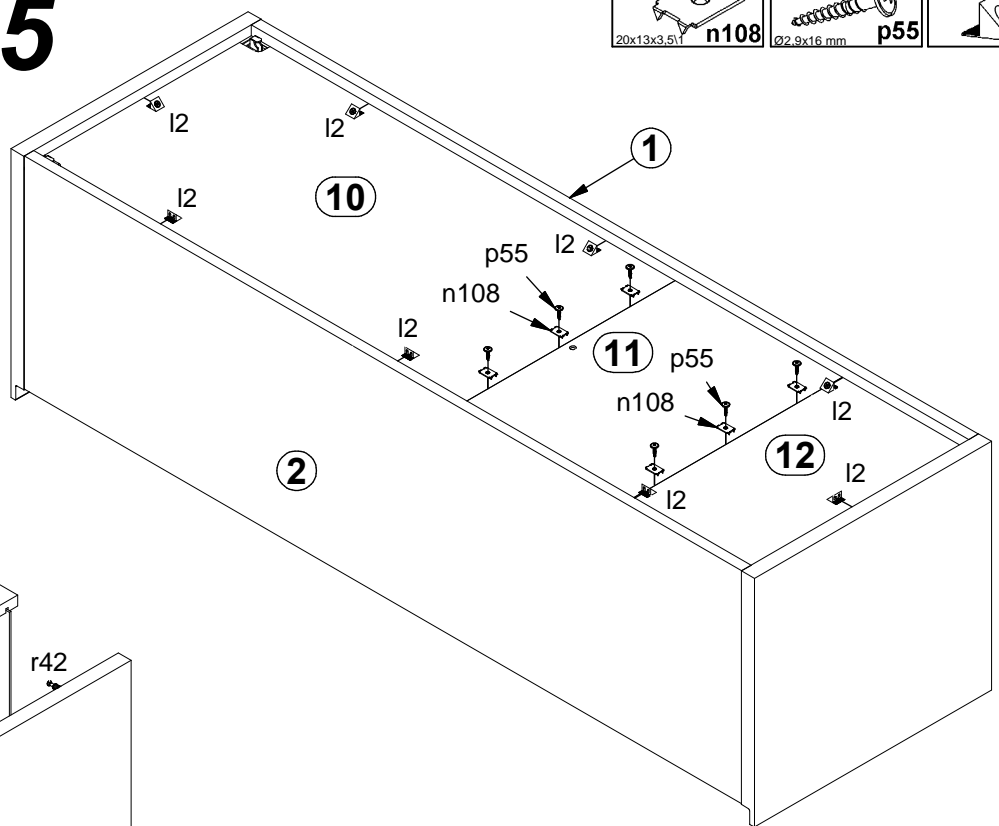

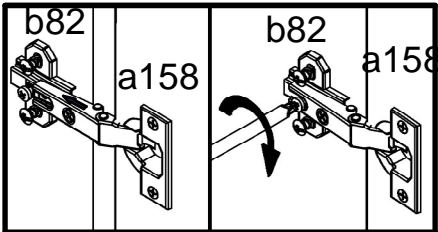

6

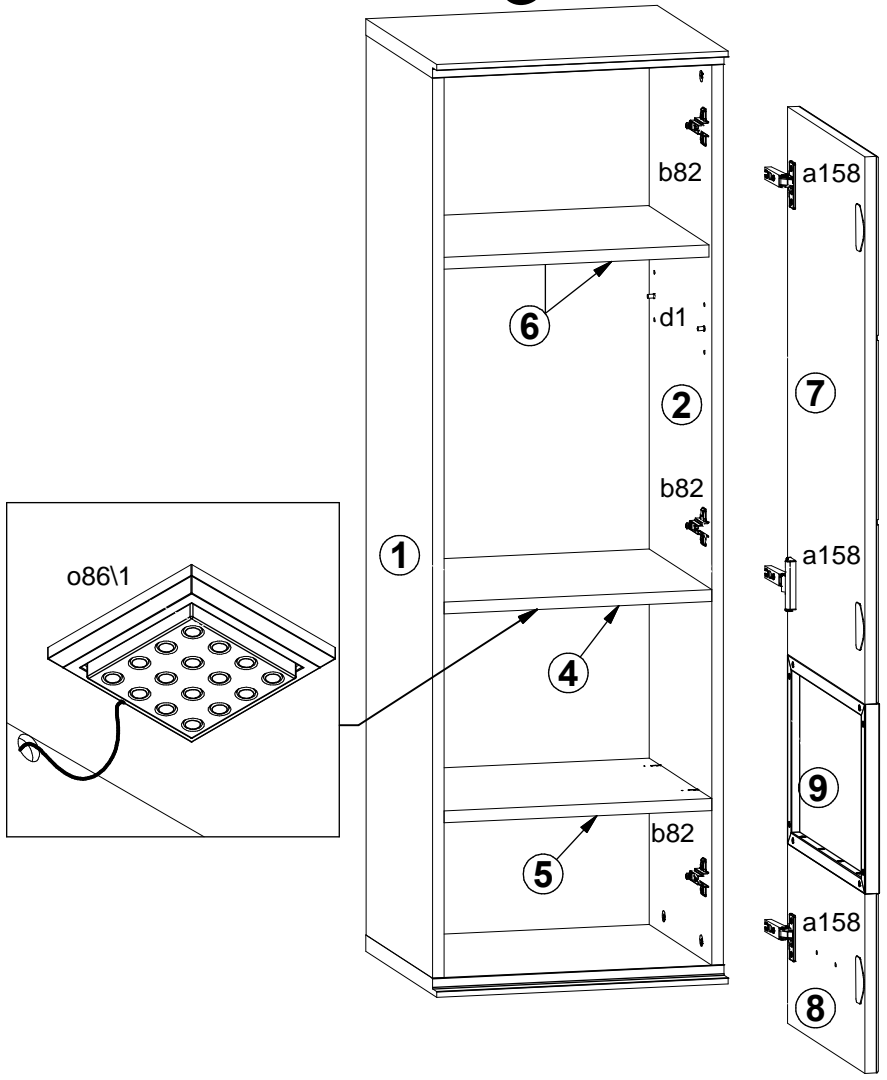

7

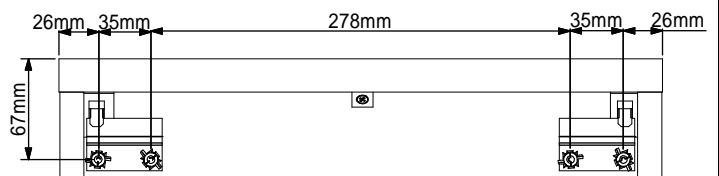
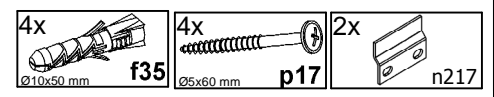
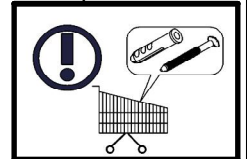
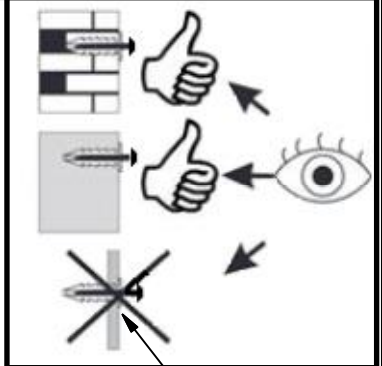
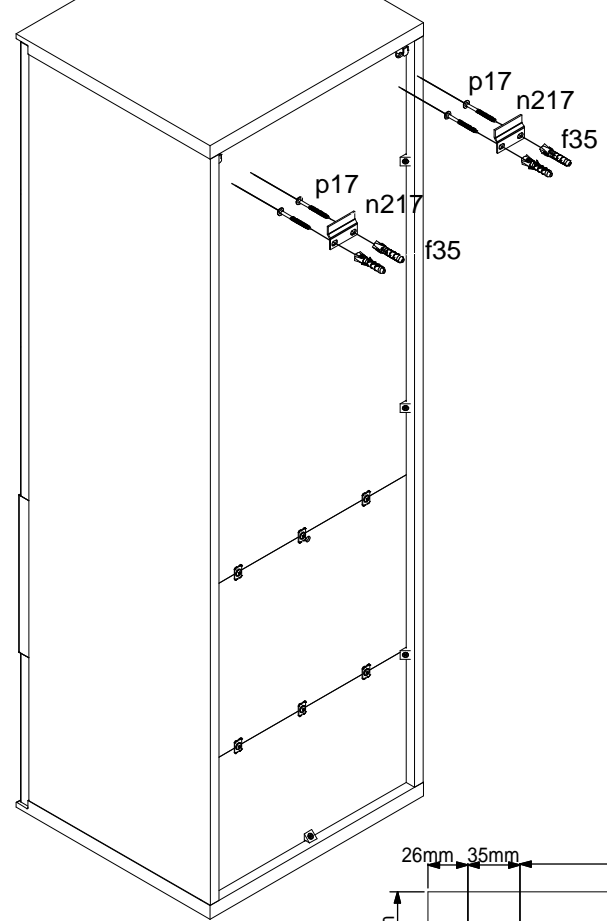
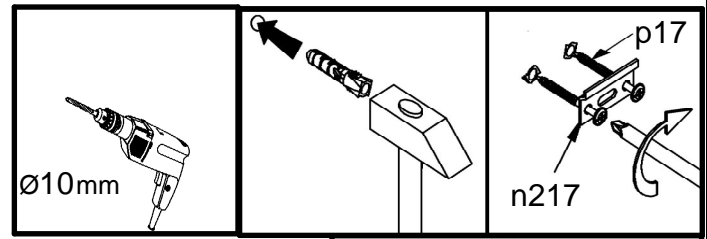



8

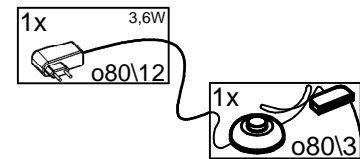
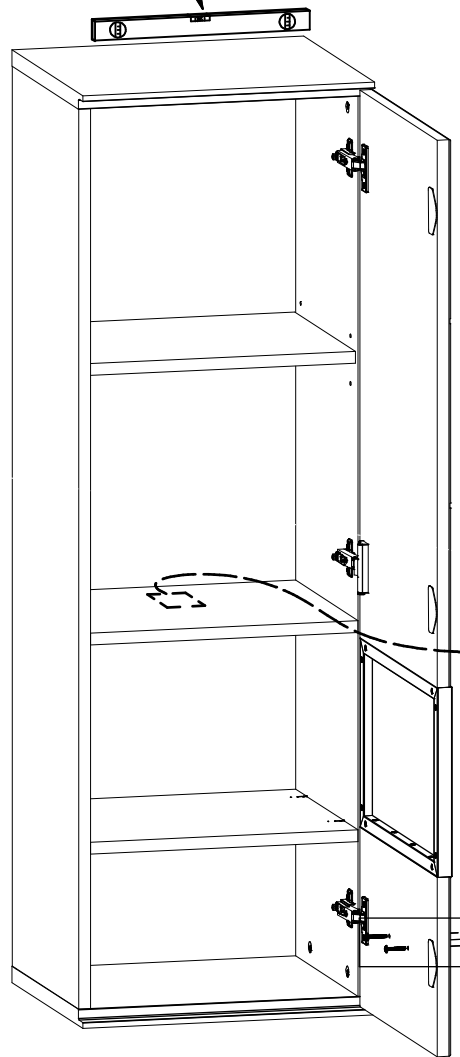
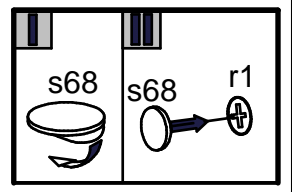
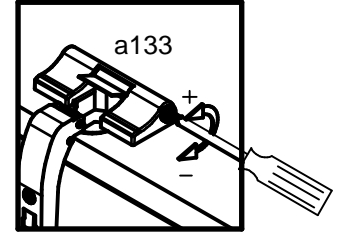
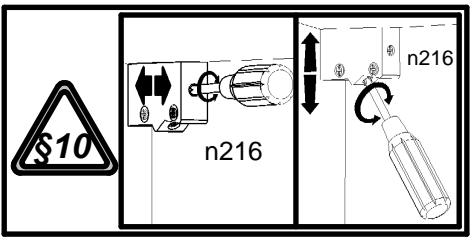
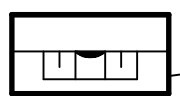

o86\1

