

30min

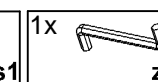

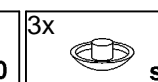

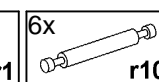
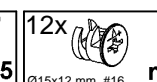
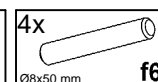
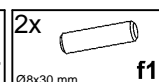
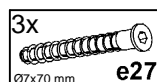
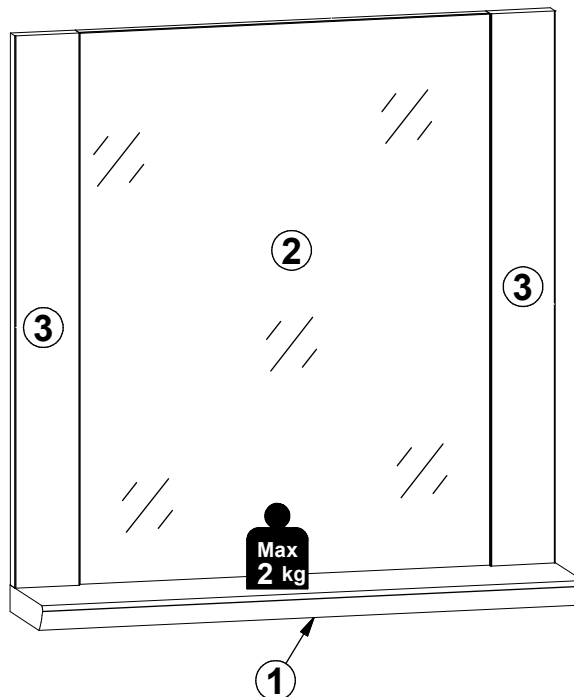
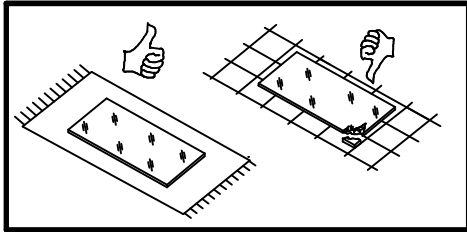
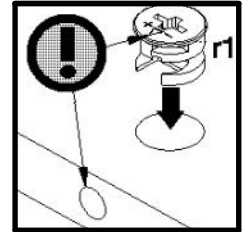

A	B	C (mm)		D
1	M222-3001	668	150	1/1
2	M222-4501	668,	507	1/1
3	M222-5001	668,	80	1/1



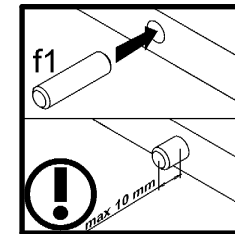
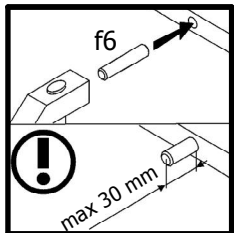
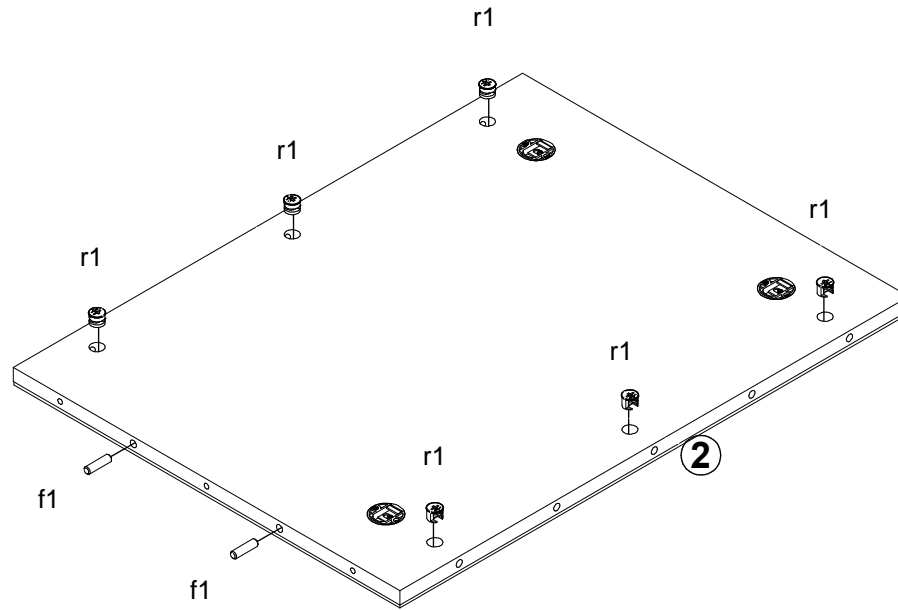
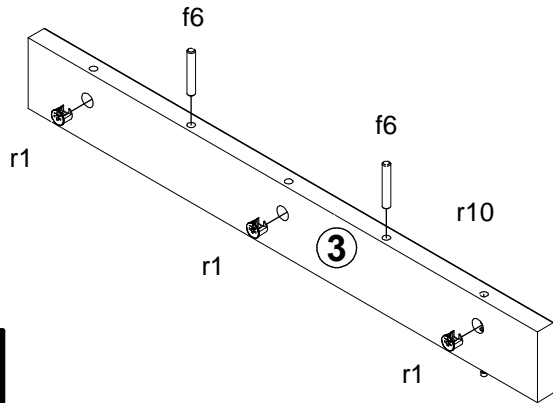

2x

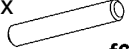

- 2x  f1
- 4x  f6
- 9x  r1

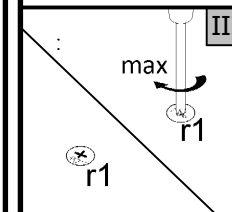
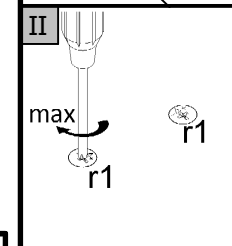
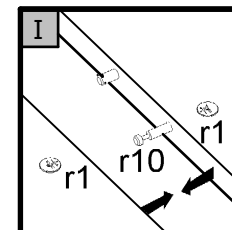
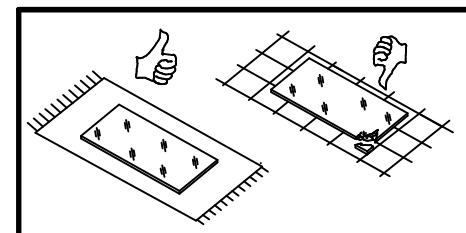
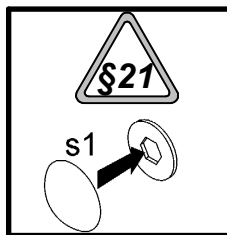
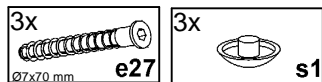
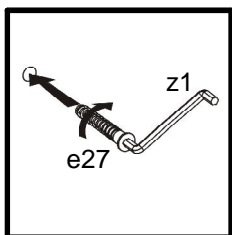
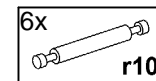
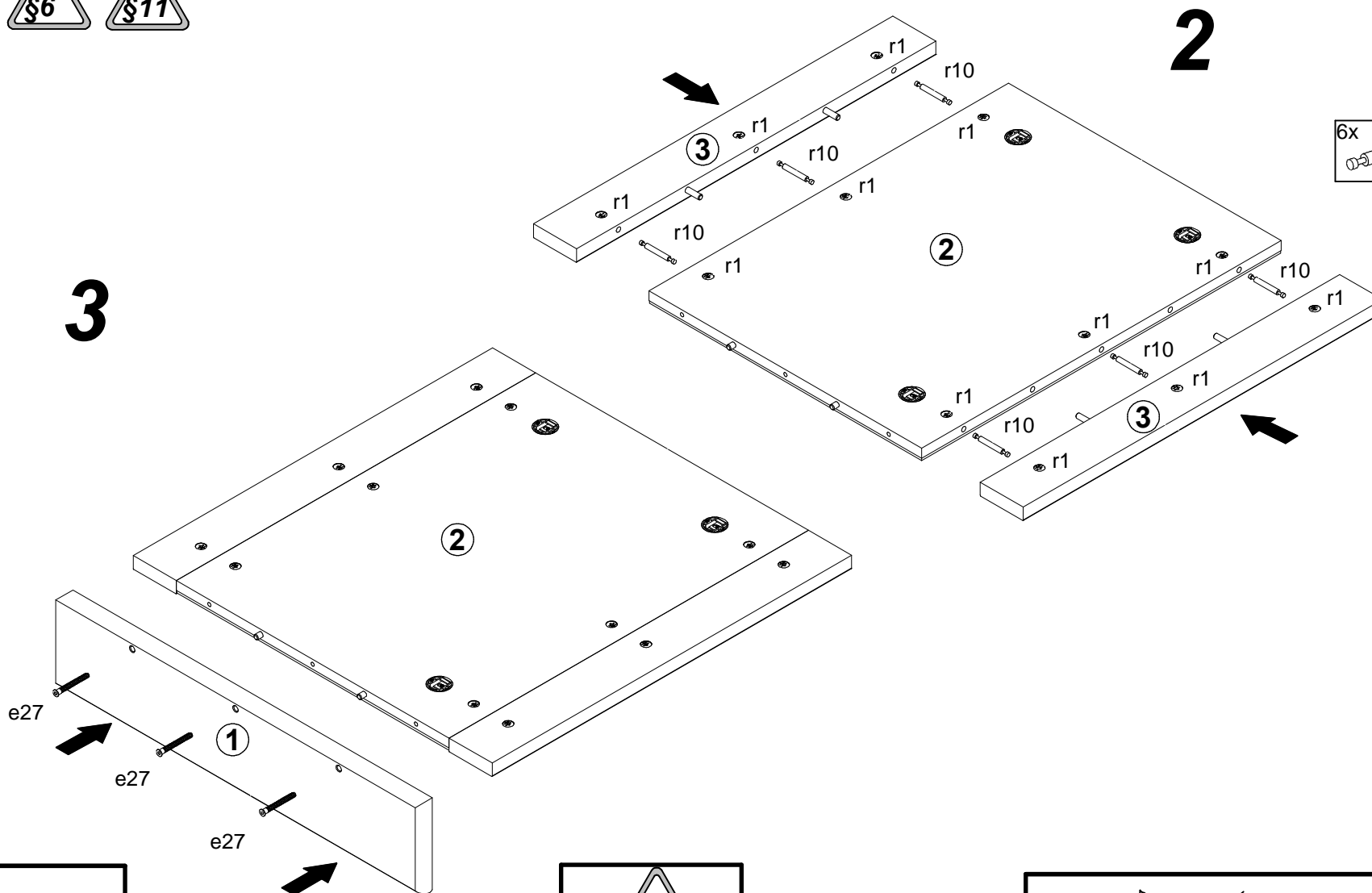

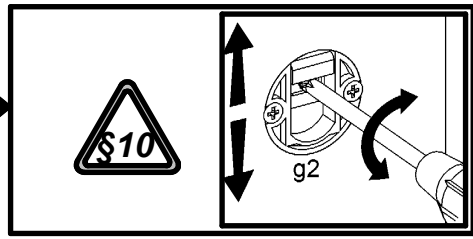
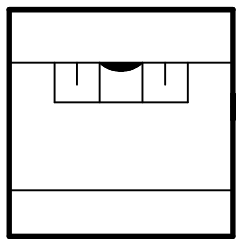

5

