

**A****M222-LUS/7/16****3096--52**

2 / 5

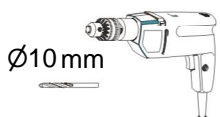

Ø10 mm

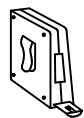
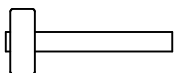
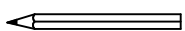
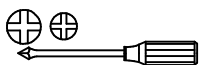
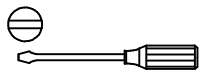
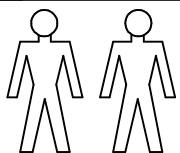
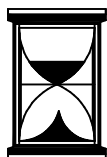

30min



A	B	C (mm)		D
1	M222-3004	1637	150	1/1
2	M222-4504	668,	1476,	1/1
3	M222-5001	668,	80	1/1

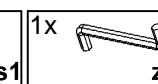
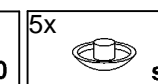
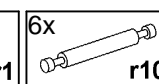
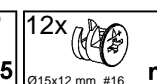
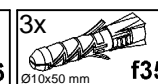
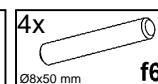
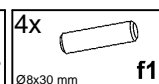
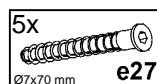
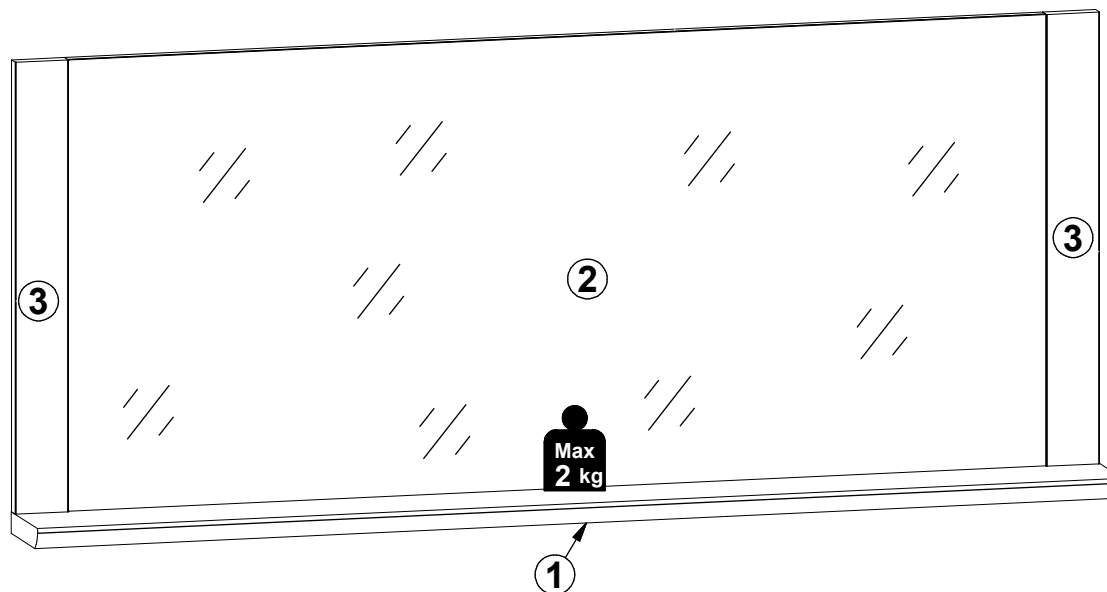

1

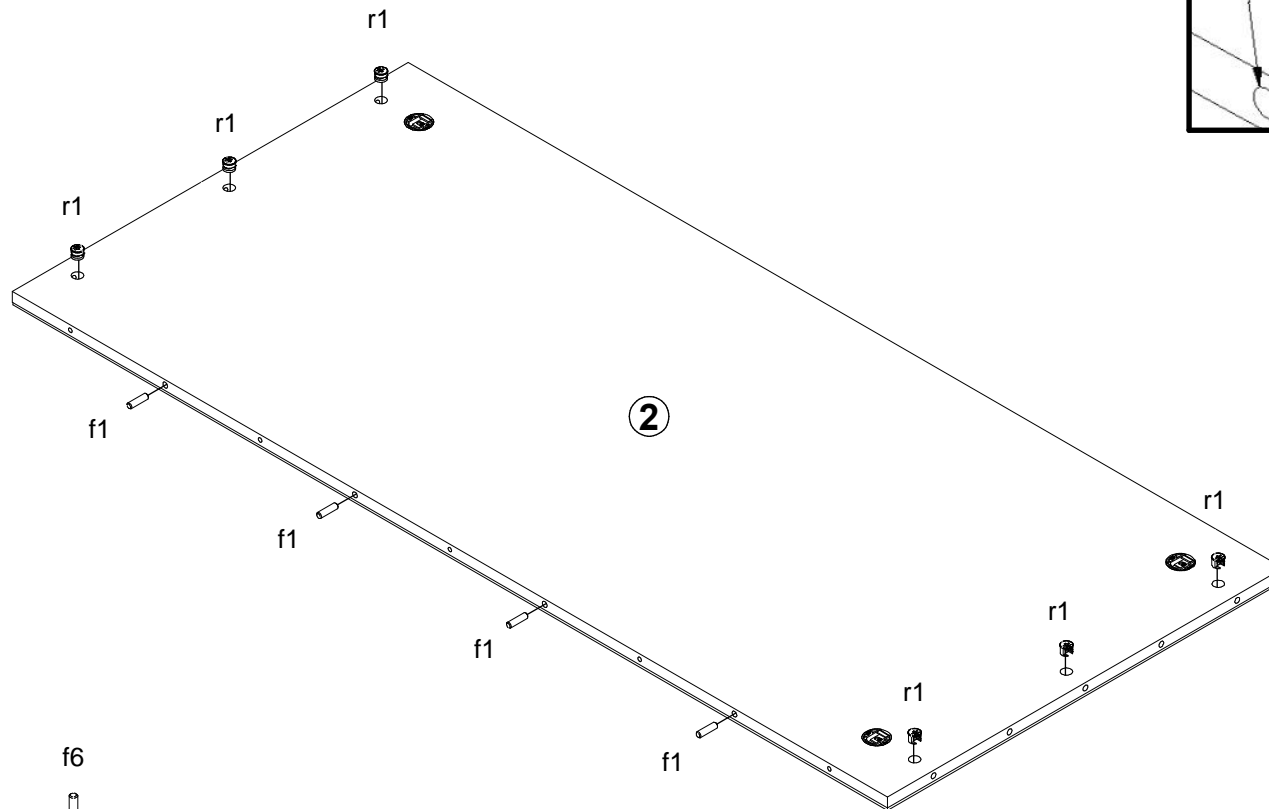
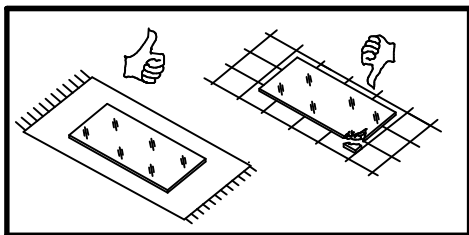
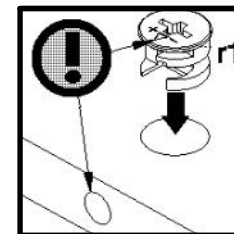

2x

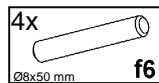
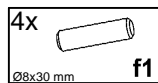
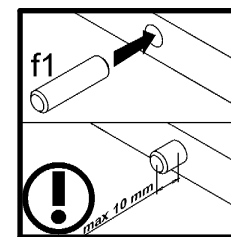
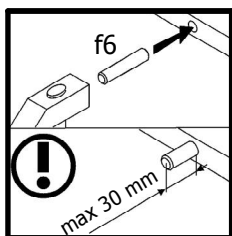
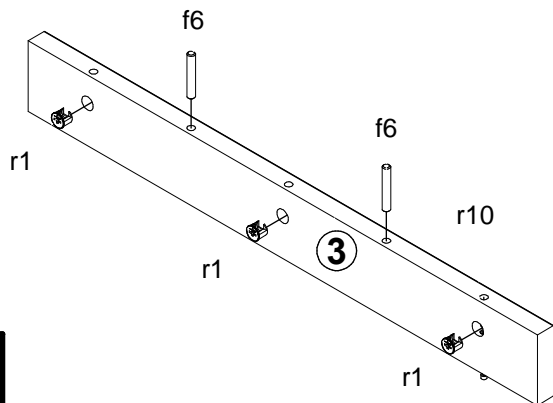

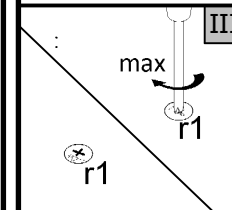
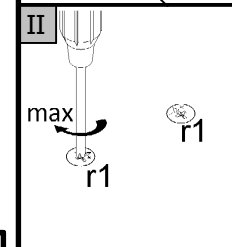
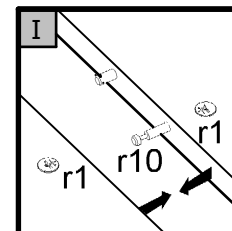
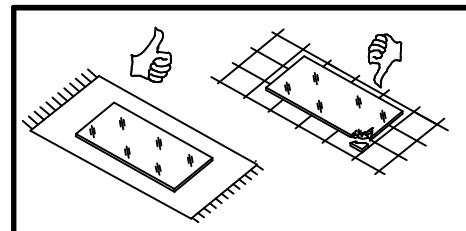
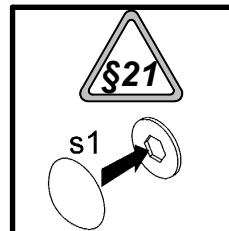
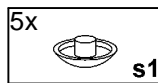
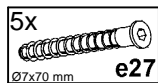
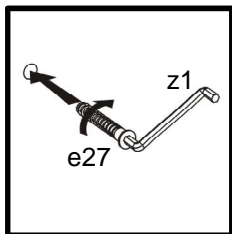
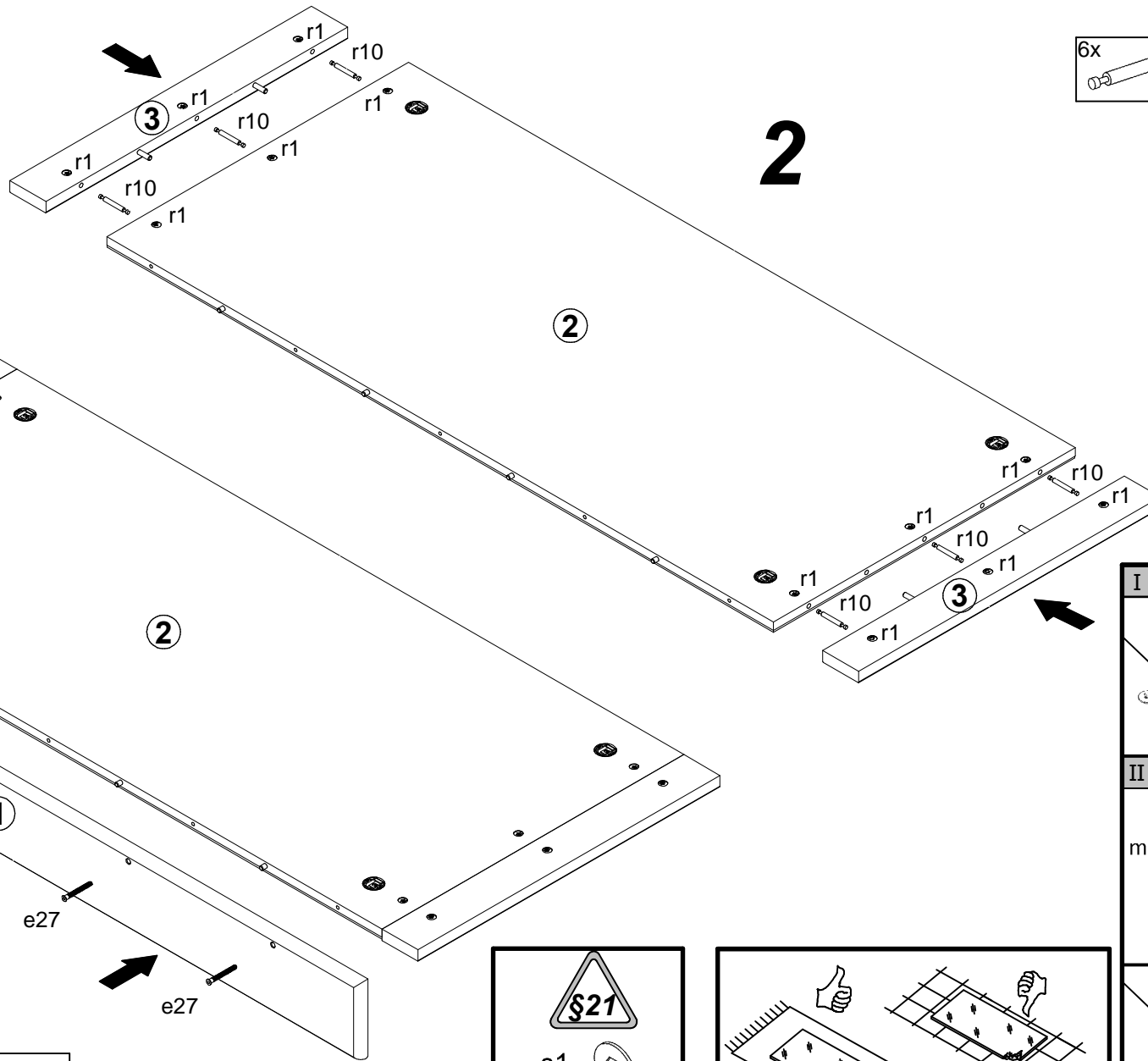
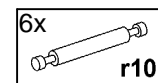

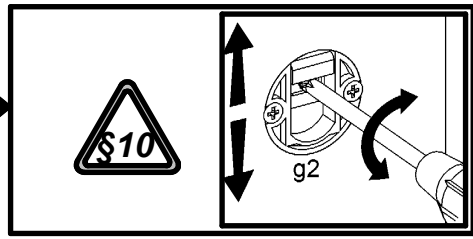
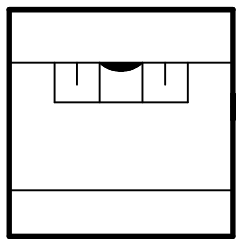

5

