

**A****M222-PAN/17/3I****3096--41**

2 /6

**30min**

A	B	C (mm)		D
1	M222-4302	848.0	316	1/1
2	M222-4303	848.0	316	1/1

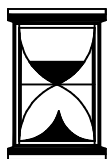
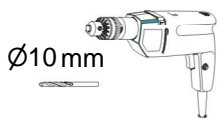
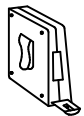
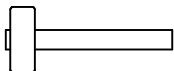
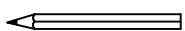
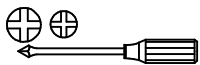
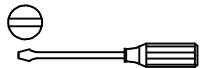
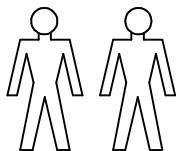
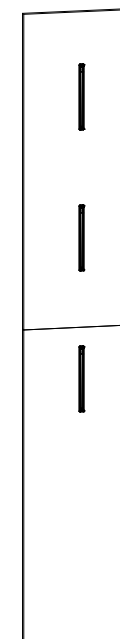
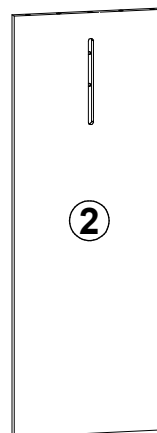
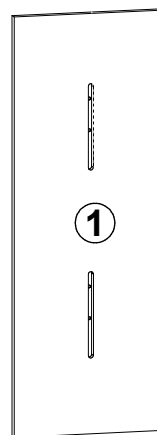

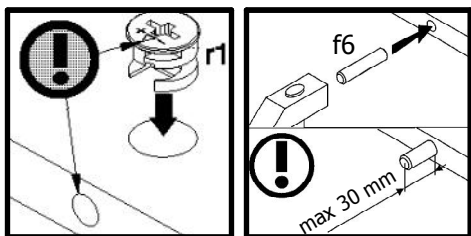

1

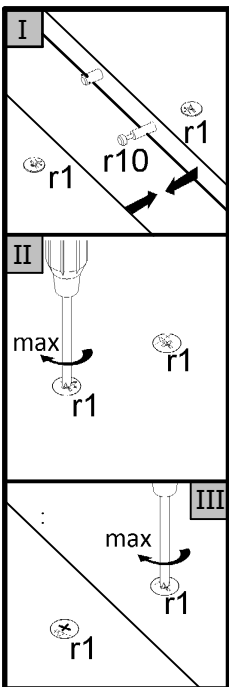
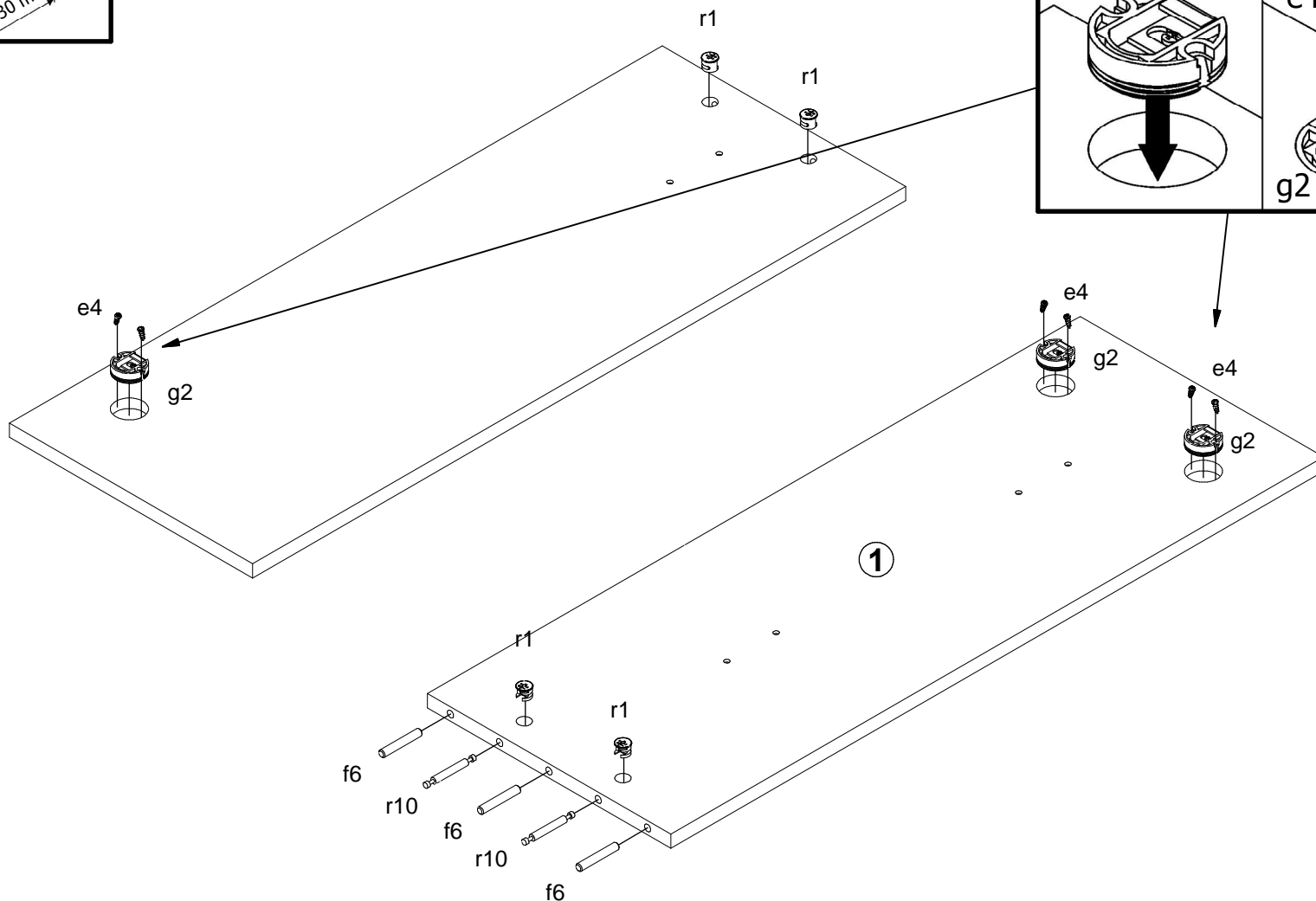
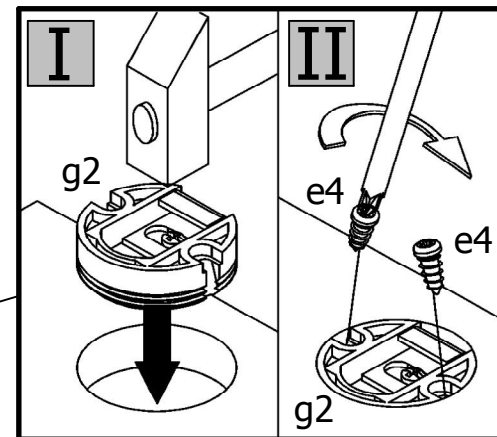

- 6x e4  
Ø5x11 mm
- 3x g2
- 4x r1  
Ø15x12 mm #16
- 2x r10
- 3x f6  
Ø8x50 mm

2

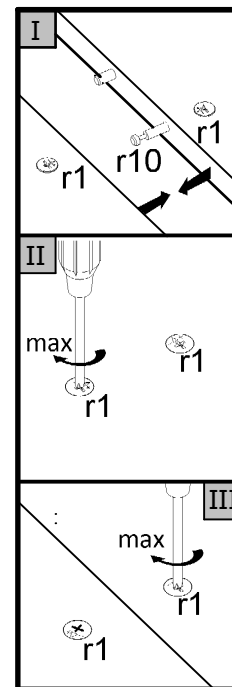
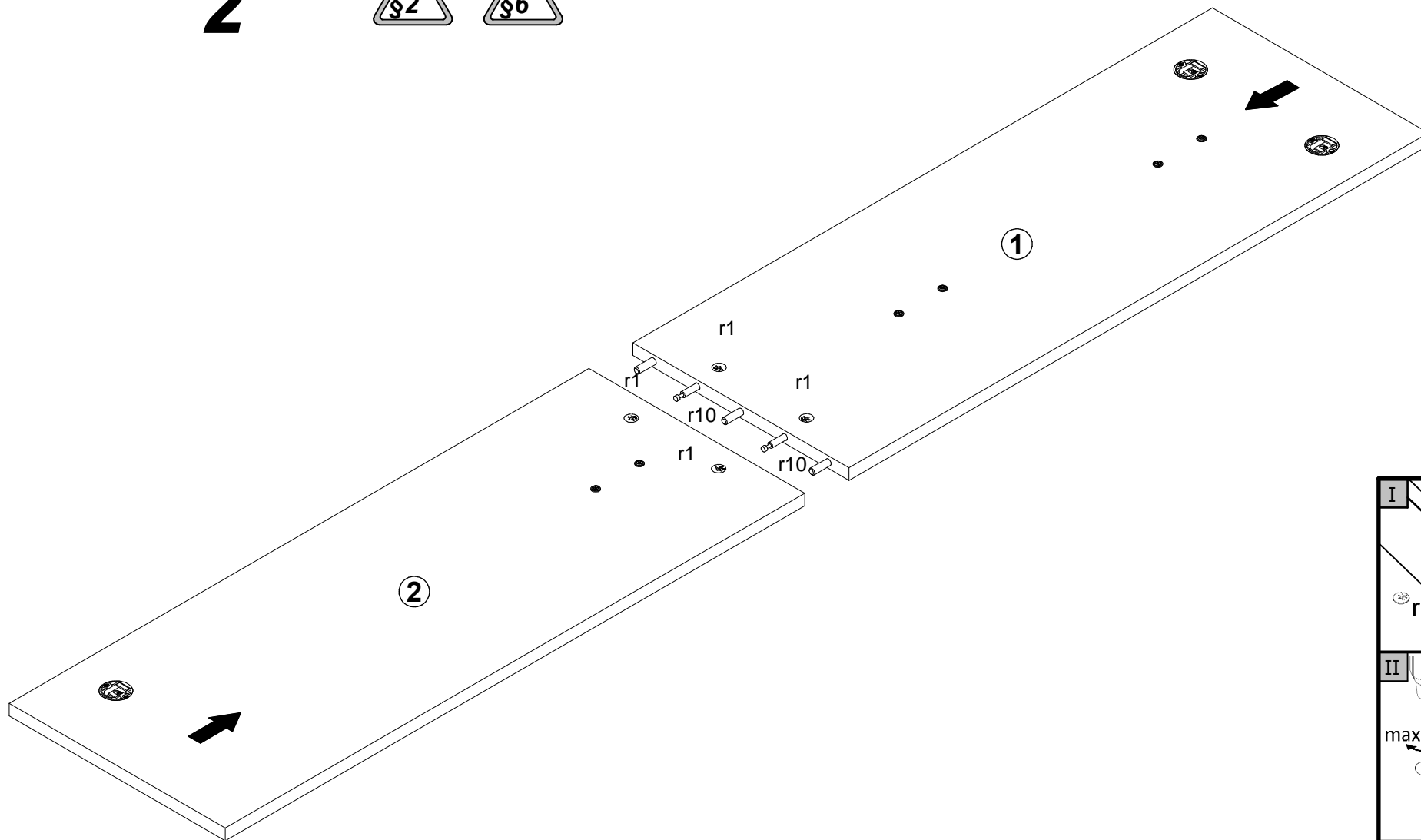



4

5

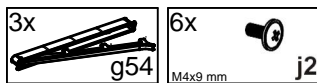
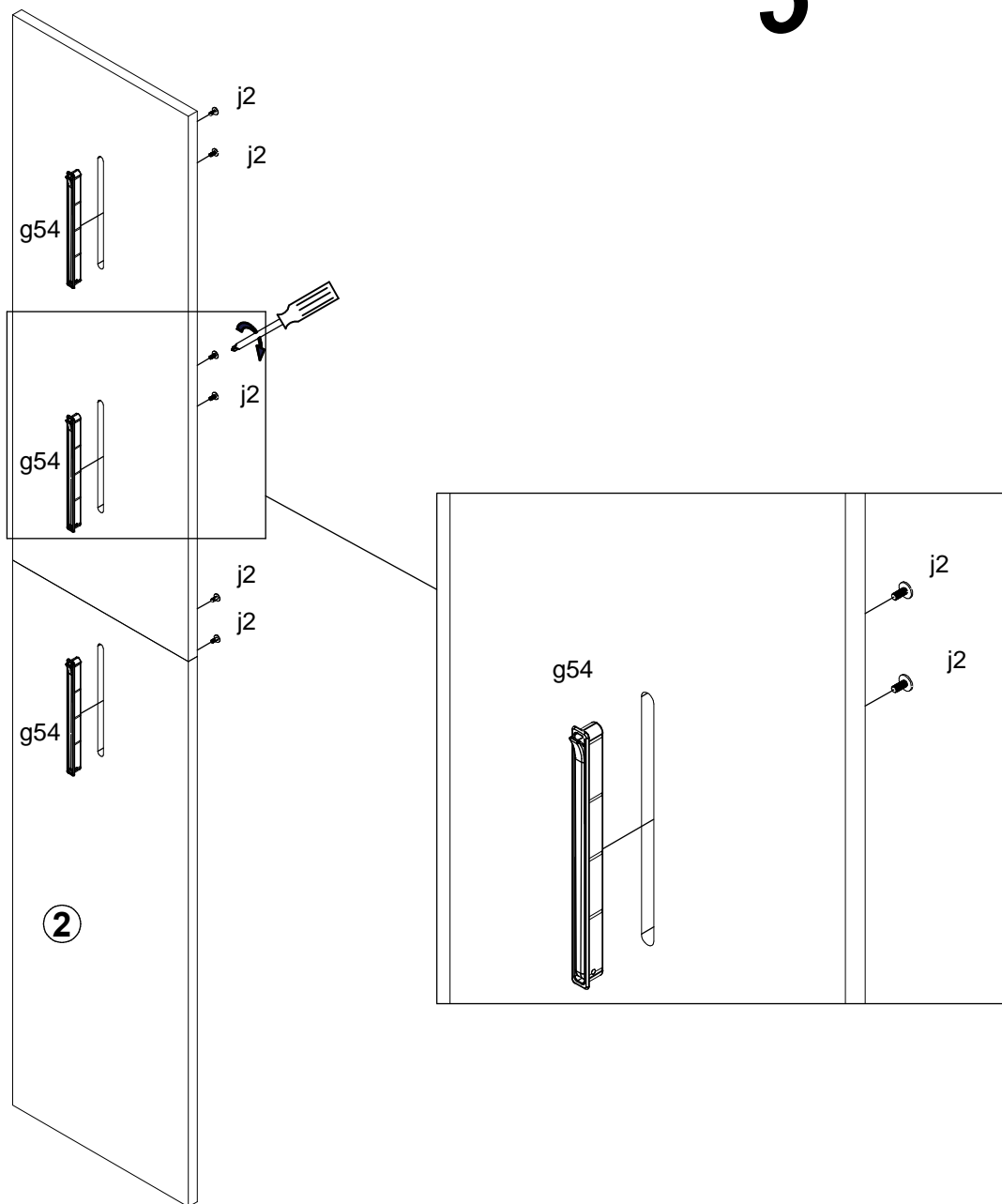

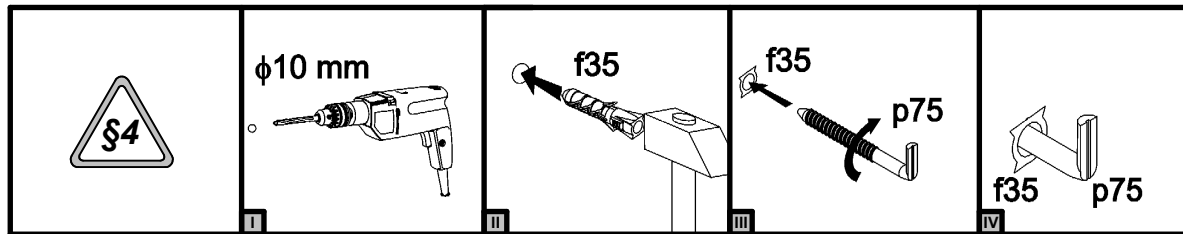
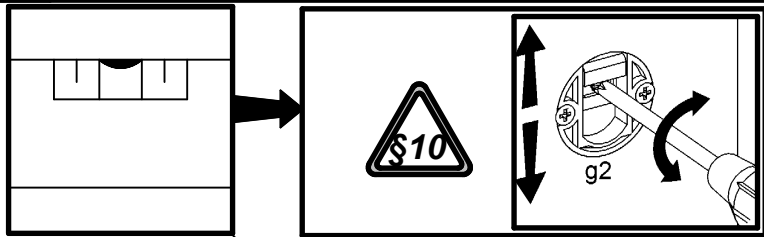

6

