

A**M222-PAN/17/3****3096--40**

2 / 5

**30min**

A	B	C (mm)		D
1	M222-4301	1696,	316	1/1

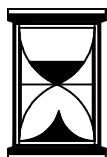
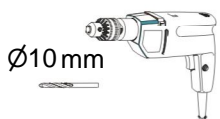
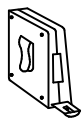
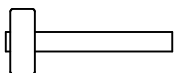
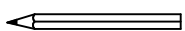
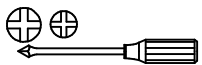
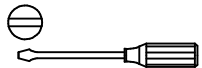
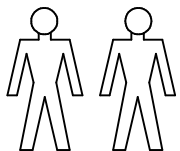
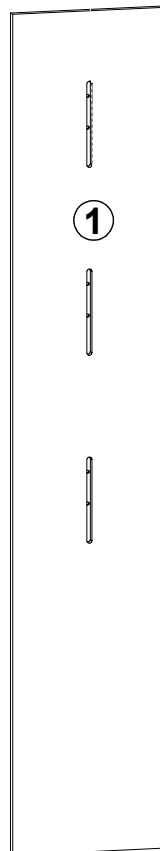
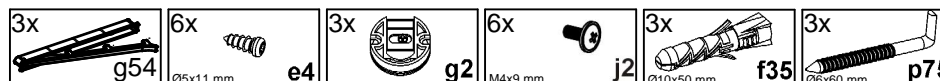
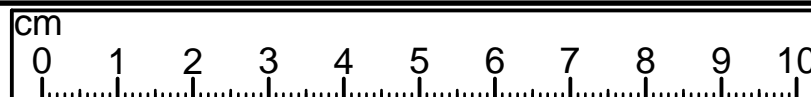
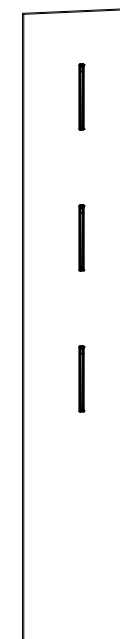

1

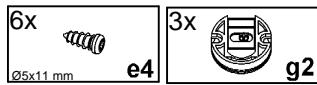
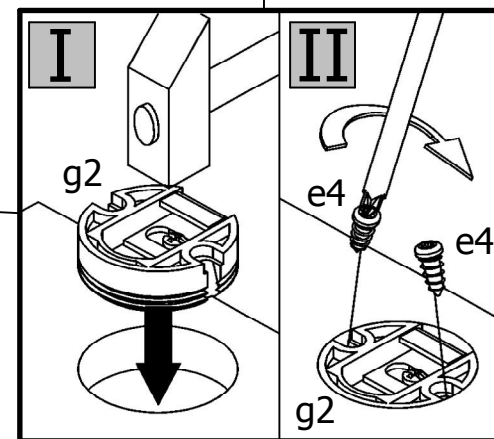
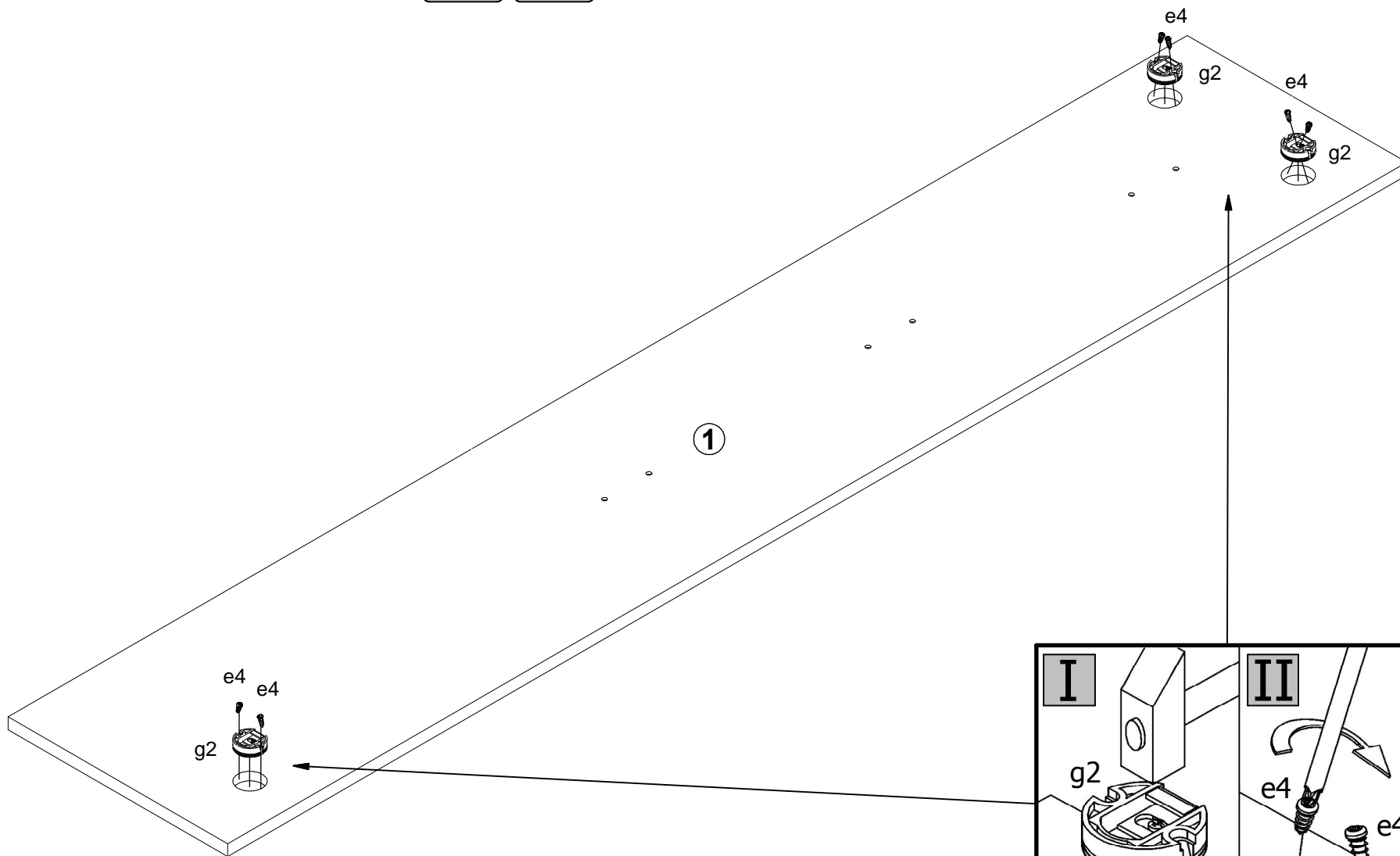



2

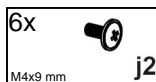
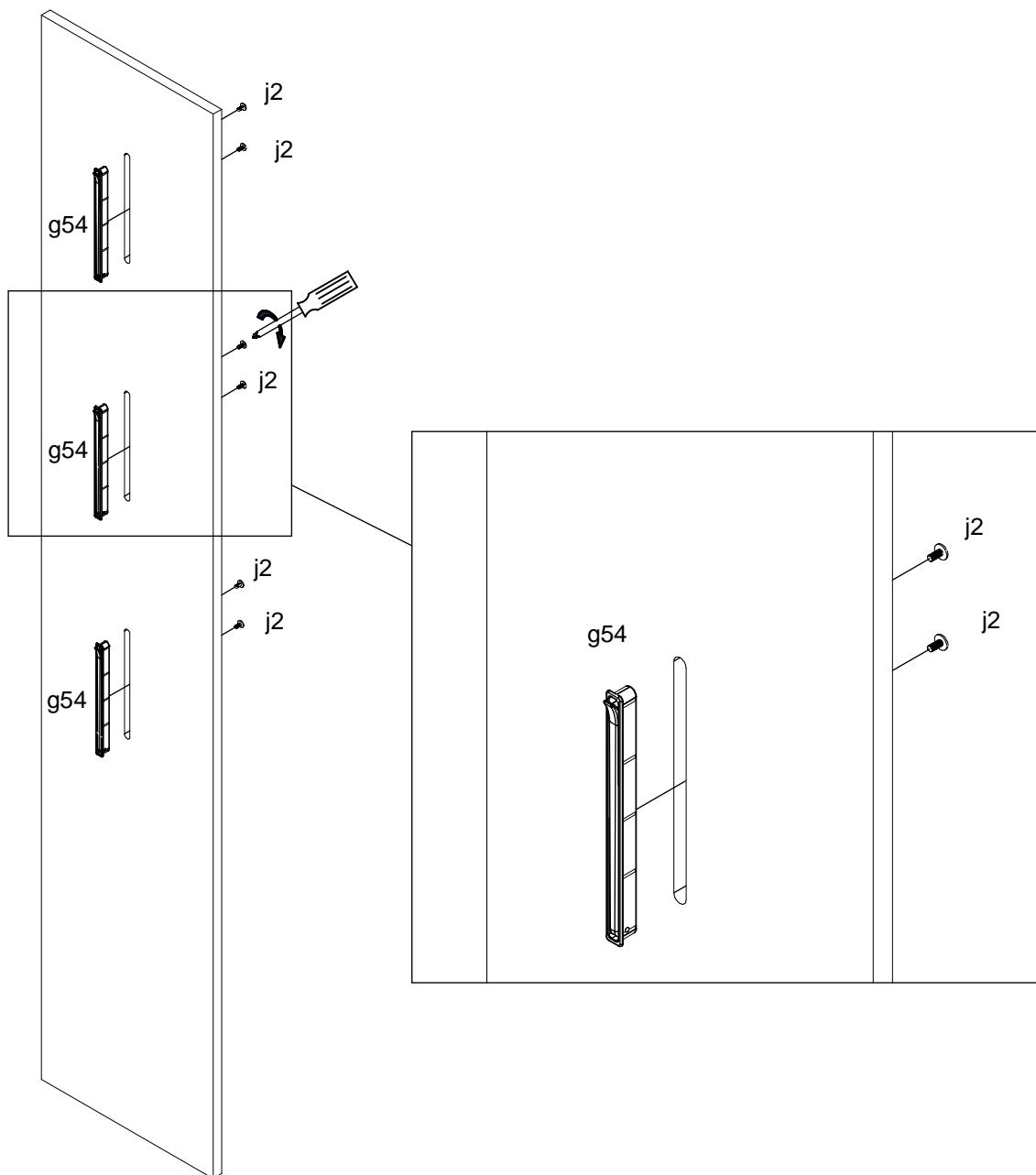

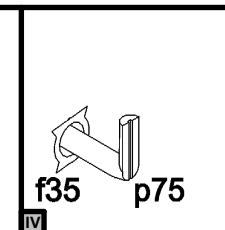
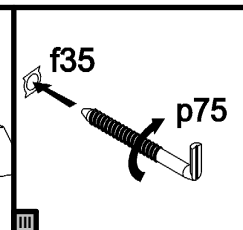
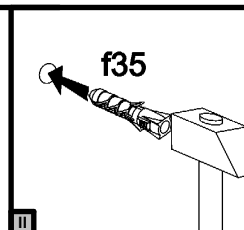
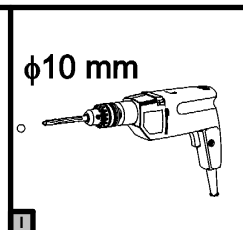
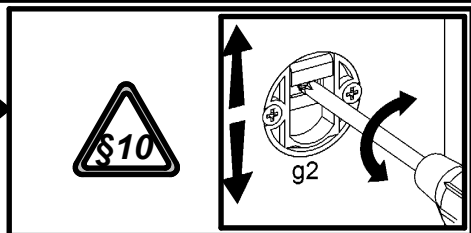
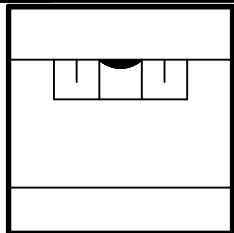

3

