

B - 792mm
H - 1960mm
T - 382mm

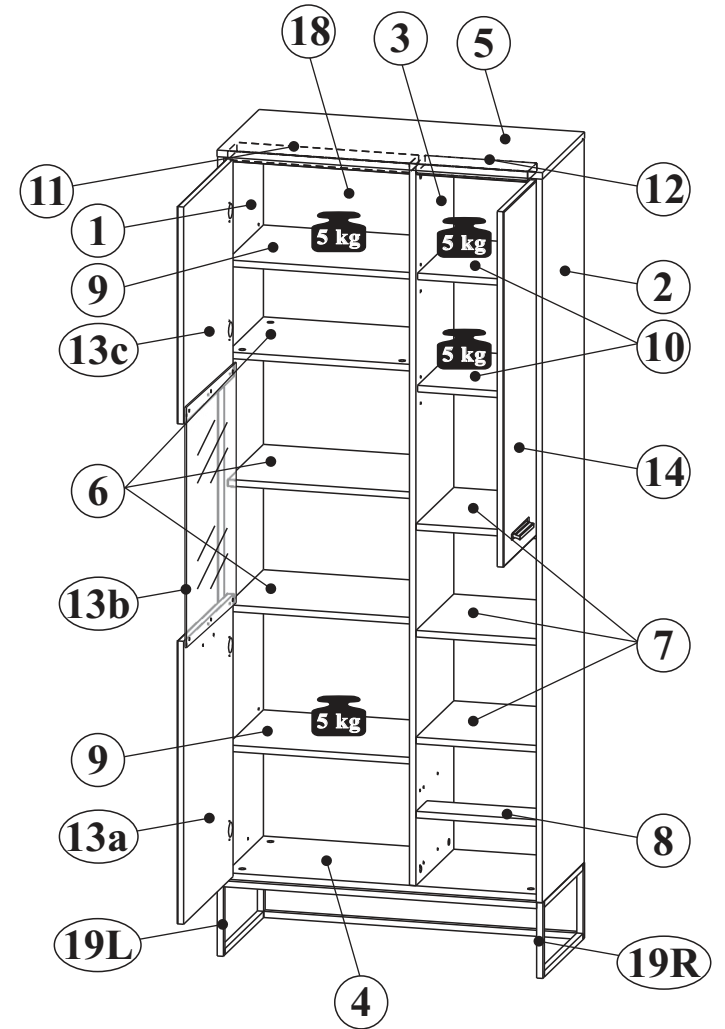

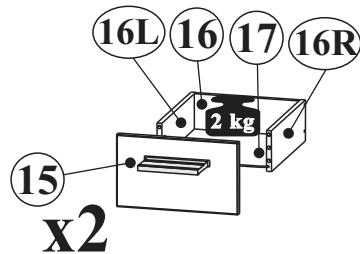

**OPTION MIT BELEUCHTUNG
99 FM WW 61**

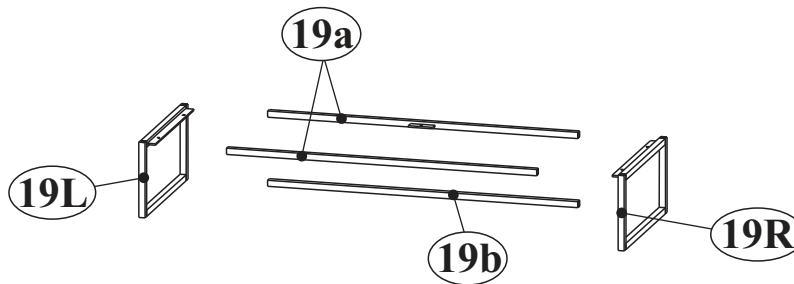
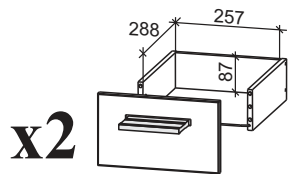
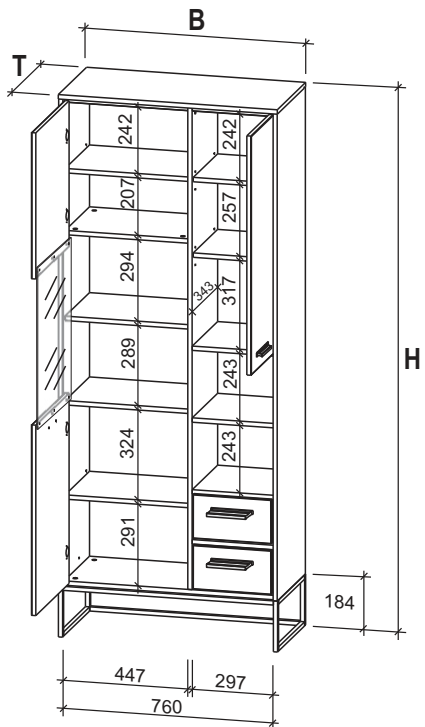
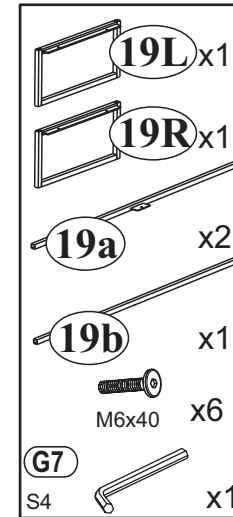
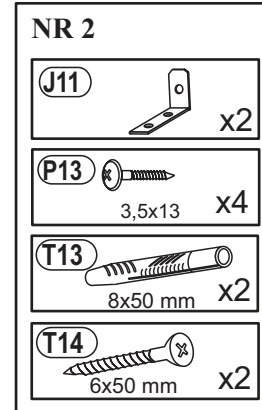
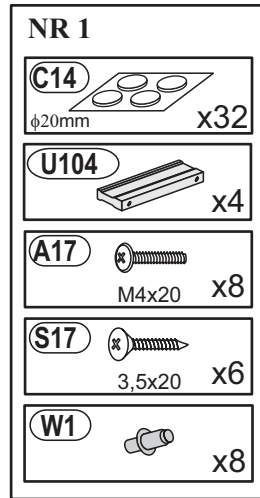

PL- Produkty te zawierają źródła światła, które ze względu na swoje właściwości nie podlegają rozporządzeniu (UE) 2019/2015	DE- Diese Produkte enthalten Lichtquellen, die aufgrund ihrer Eigenschaften nicht unter die Verordnung (EU) 2019/2015 fallen	CS- Tyto výrobky obsahují světelné zdroje, které vzhledem ke svým vlastnostem nespadají do oblasti působnosti nařízení (EU) 2019/2015
DA- Disse produkter indeholder lyskilder, som på grund af deres egenskaber er uden for anvendelsesområdet for forordning (EU) 2019/2015	EL- Αυτά τα προϊόντα περιέχουν πηγές φωτός οι οποίες, λόγω των ιδιοτήτων τους, δεν εμπίπτουν στο πεδίο εφαρμογής του κανονισμού (ΕΕ) 2019/2015	EN- These products contain light sources which, due to their properties, are out of the scope of Regulation (EU) 2019/2015
ES- Estos productos contienen fuentes de luz que, por sus propiedades, quedan fuera del ámbito de aplicación del Reglamento (UE) 2019/2015.	ET- Need tooted sisaldavad valgusallikaid, mis oma omaduste tõttu jäävad määruse (UE) 2019/2015 reguleerimisalast välja	FI- Nämä tuotteet sisältävät valonlähteitä, jotka ominaisuuksiensa vuoksi eivät kuulu asetuksen (EU) 2019/2015 soveltamisalaan
FR- Ces produits contiennent des sources lumineuses qui, en raison de leurs propriétés, n'entrent pas dans le champ d'application du règlement (UE) 2019/2015	HU- Ezek a termékek olyan fényforrásokat tartalmaznak, amelyek tulajdonságaik miatt nem tartoznak az (EU) 2019/2015 rendelet hatálya alá	IT- Questi prodotti contengono sorgenti luminose che, per le loro proprietà, esulano dal campo di applicazione del Regolamento (UE) 2019/2015
LT- Šiuose gaminių yra šviesos šaltiniai, kurie dėl savo savybių nepatenka į Reglamento (UE) 2019/2015 taikymo sritį	LV- Šie produkti satur gaismas avotus, kas to prasību dēļ ir ārpus Regulas (UE) 2019/2015 darbības jomas	RU- Эти продукты содержат источники света, которые из-за своих свойств не подпадают под действие Регламента (ЕС) 2019/2015.
PT- Estes produtos contêm fontes de luz que, devido às suas propriedades, estão fora do âmbito do Regulamento (UE) 2019/2015	RO- Aceste produse conțin surse de lumină care, datorită proprietăților lor, nu intră în domeniul de aplicare al Regulamentului (UE) 2019/2015	NL- Deze producten bevatten lichtbronnen die vanwege hun eigenschappen buiten het toepassingsgebied van Verordening (EU) 2019/2015 vallen
SK- Tieto výrobky obsahujú svetelné zdroje, ktoré vzhľadom na svoje vlastnosti nepatria do rozsahu pôsobnosti nariadenia (EÚ) 2019/2015	SLO- Ti izdelki vsebujejo svetlobne vire, ki zaradi svojih lastnosti ne spadajo na področje uporabe Uredbe (EU) 2019/2015	SV- Dessa produkter innehåller ljuskällor som på grund av sina egenskaper inte omfattas av förordning (EU) 2019/2015
TR- Bu ürünler, özellikleri nedeniyle (UE) 2019/2015 Yönetmeliğinin kapsamı dışında kalan ışık kaynakları içerir.	HR- Ovi proizvodi sadrže izvore svjetlosti koji zbog svojih svojstava nisu obuhvaćeni Uredbom (EU) 2019/2015	BG- Тези продукти съдържат източници на светлина, които поради своите свойства са извън обхвата на Регламент (ЕС) 2019/2015

1

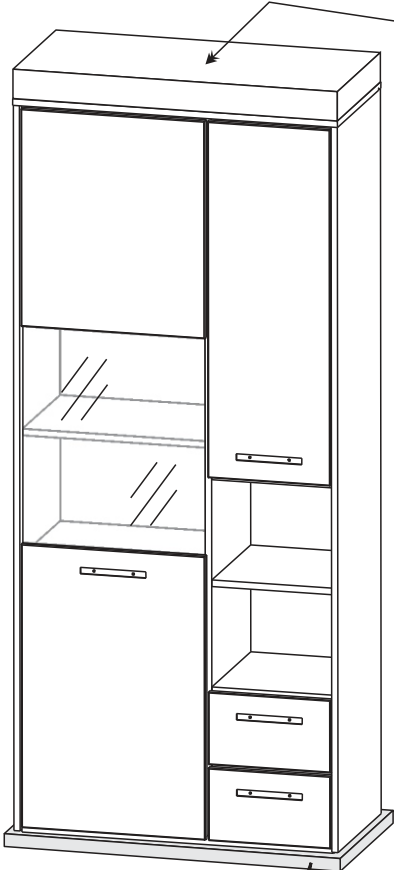

- 19L** x1
- 19R** x1
- 19a** x2
- 19b** x1
- M6x40 x6
- G7** S4 x1

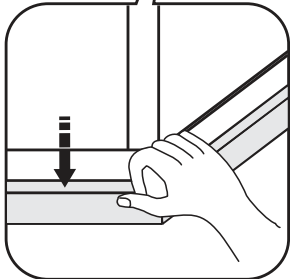
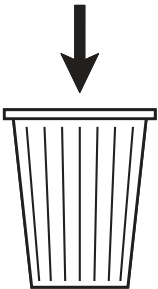

2

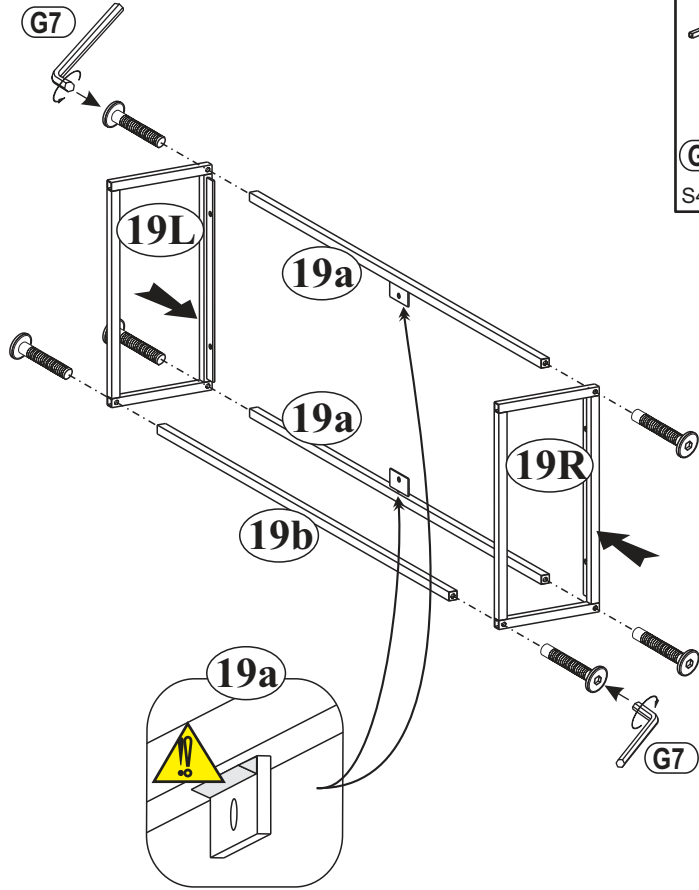

- 19L** x1
- 19R** x1
- 19a** x2
- 19b** x1
- M6x40 x6
- G7** S4 x1

3

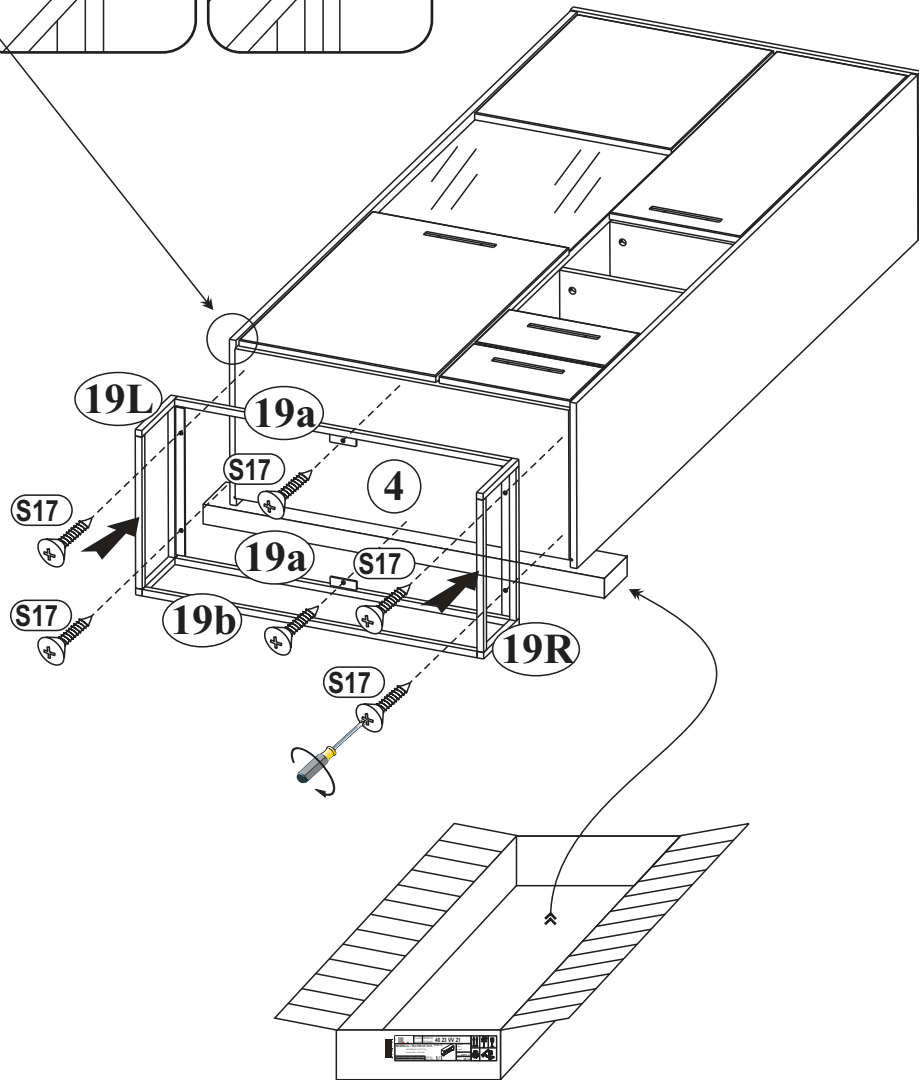
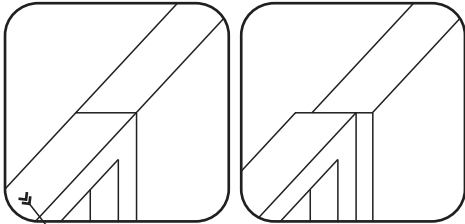
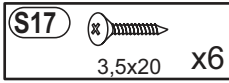

4

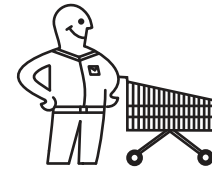

OPTION MIT BELEUCHTUNG
2 x 99 FM WW 61

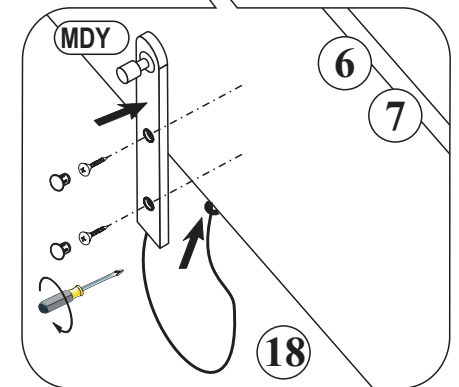
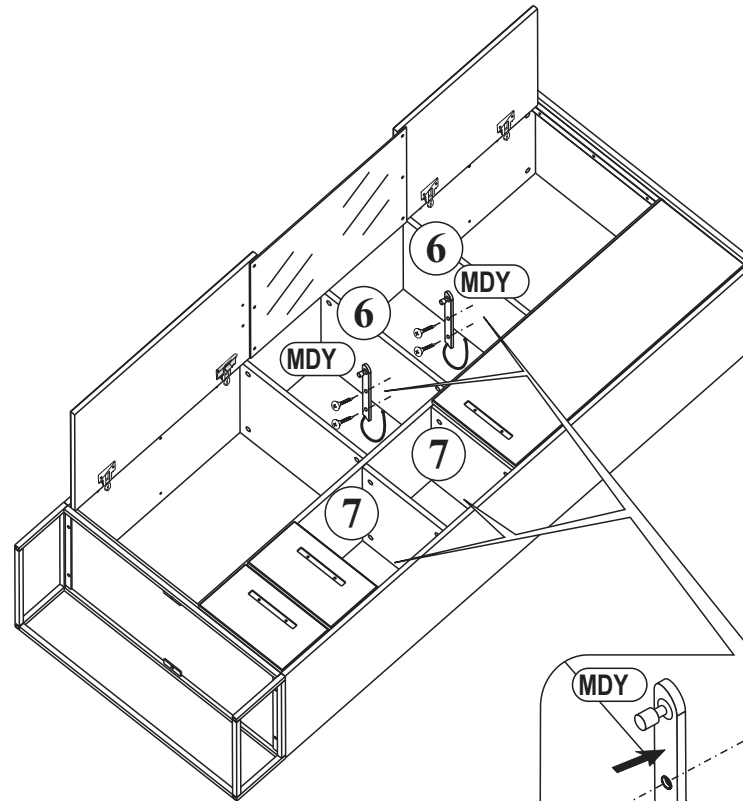
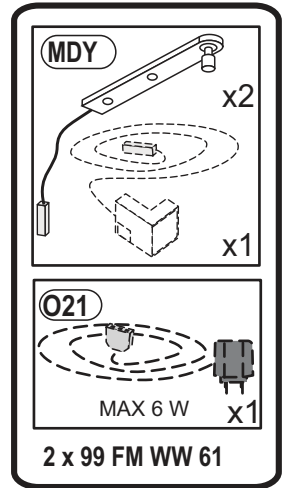

5

OPTION MIT BELEUCHTUNG

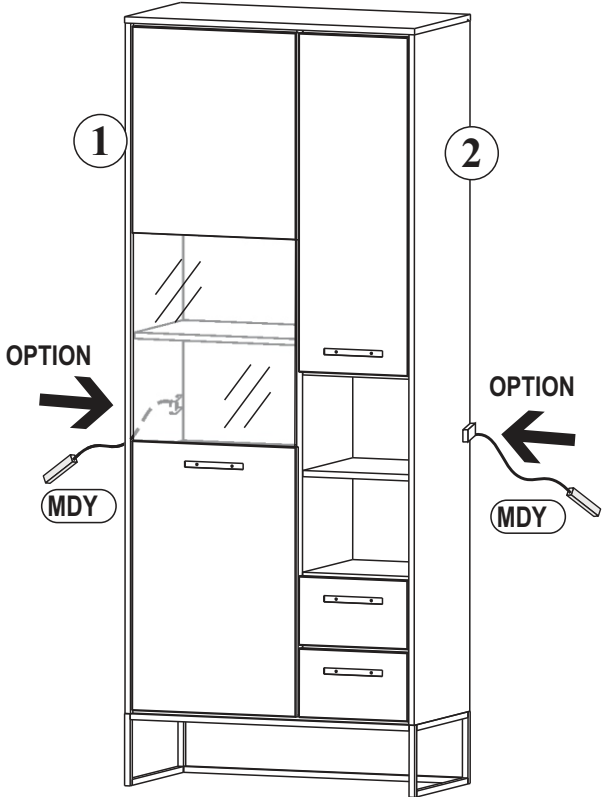
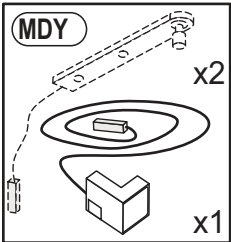

6

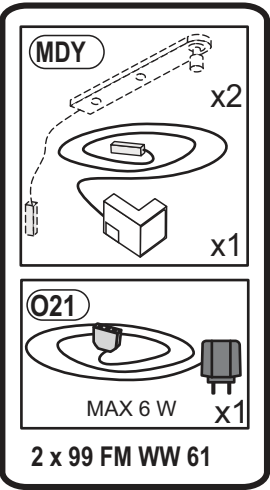
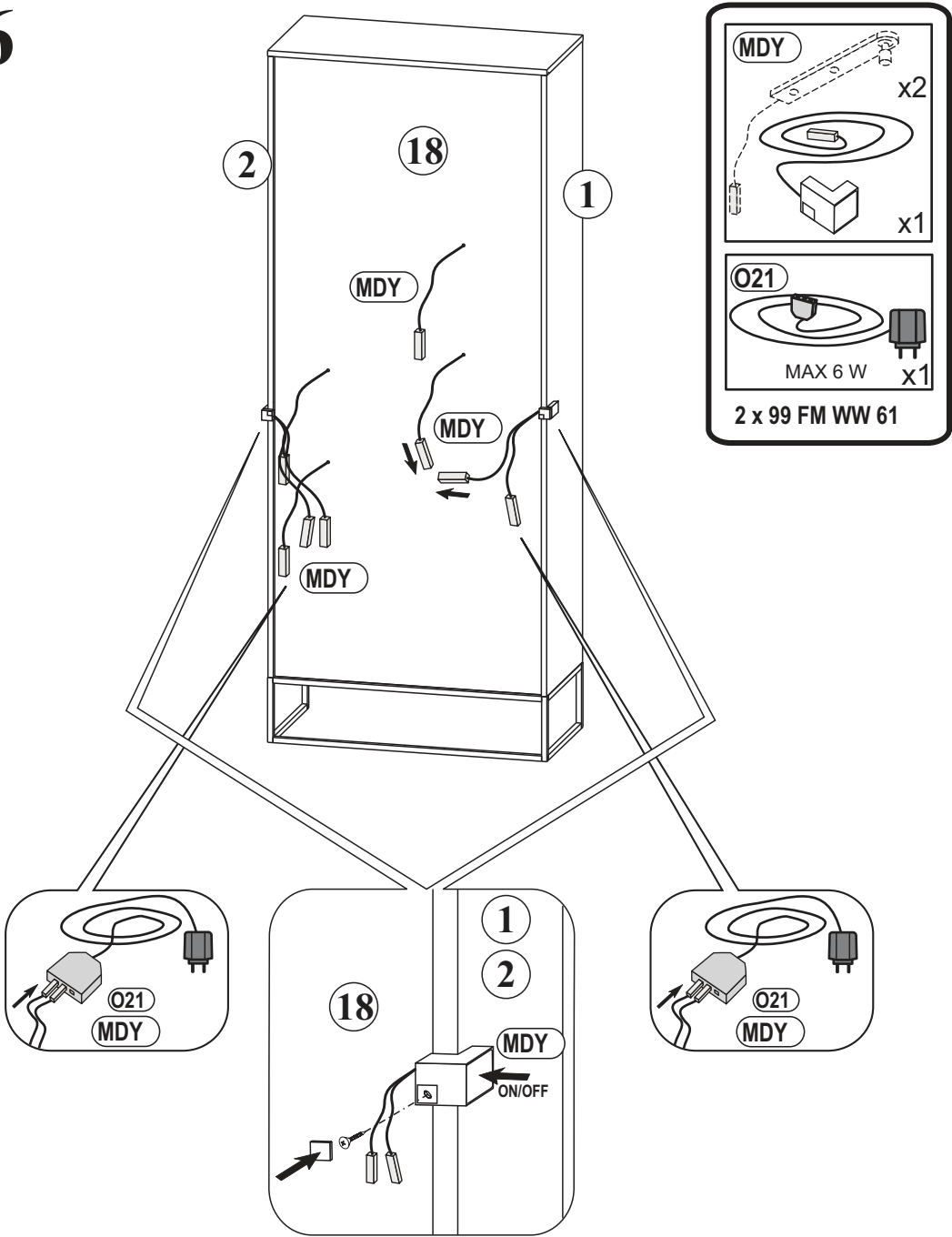

7

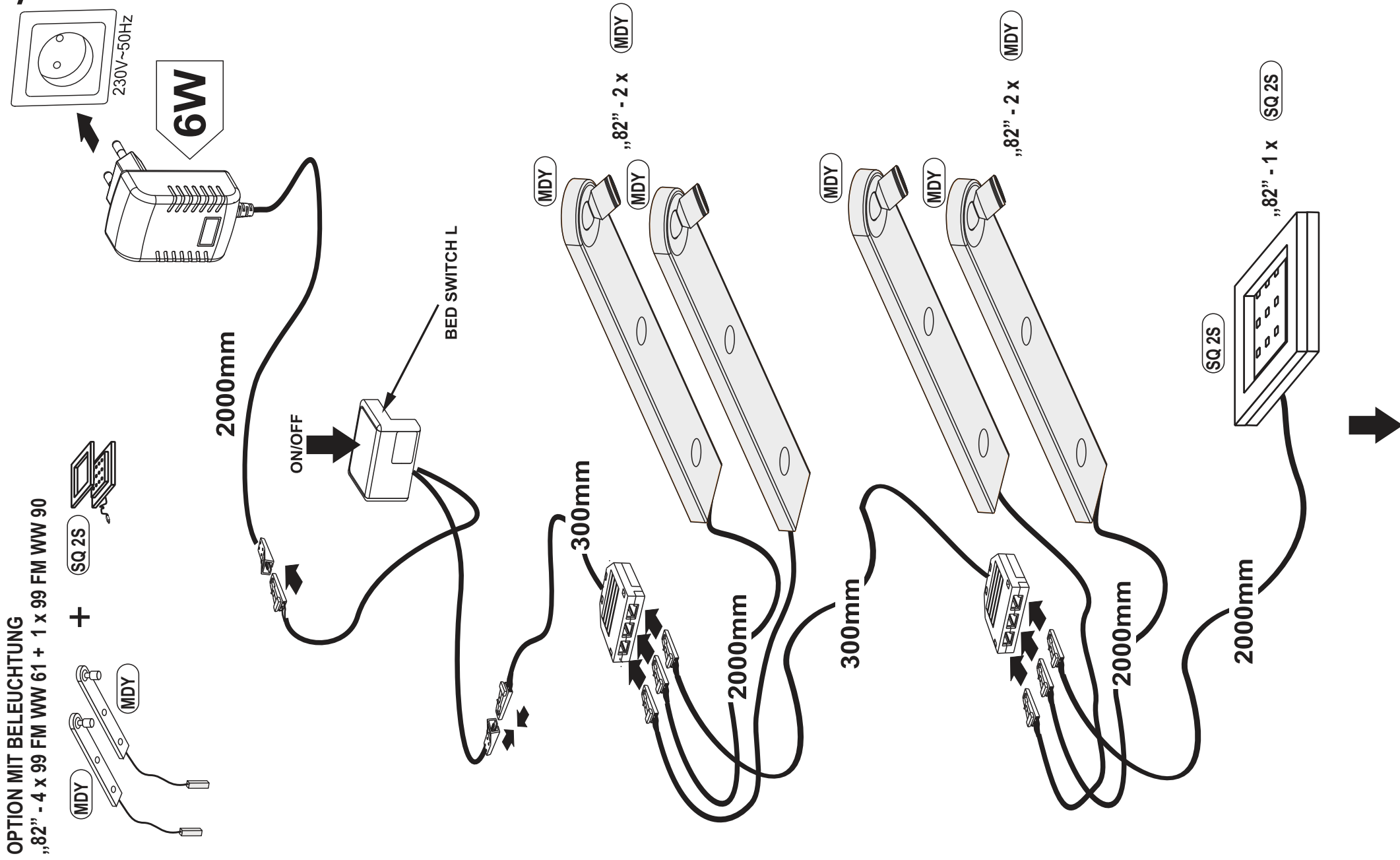

7a

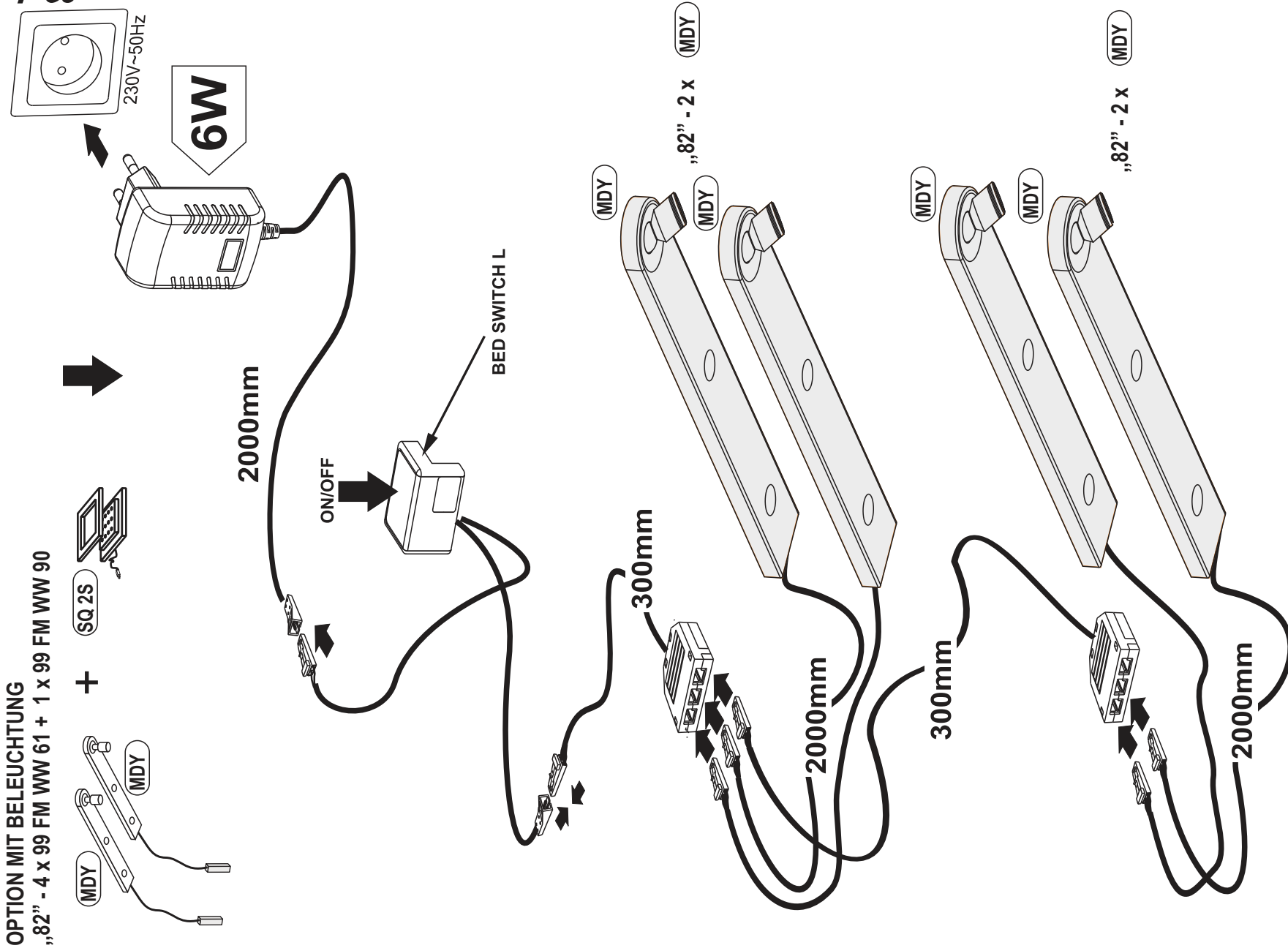

OPTION MIT BELEUCHTUNG
„82“ - 4 x 99 FM WW 61 + 1 x 99 FM WW 90



SQ 2S

+

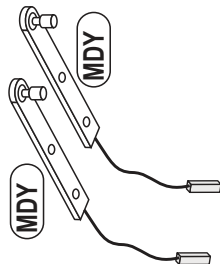

MDY

6W

2000mm

ON/OFF

BED SWITCH L

300mm

2000mm

300mm

2000mm

„82“ - 2 x MDY

„82“ - 2 x MDY

8

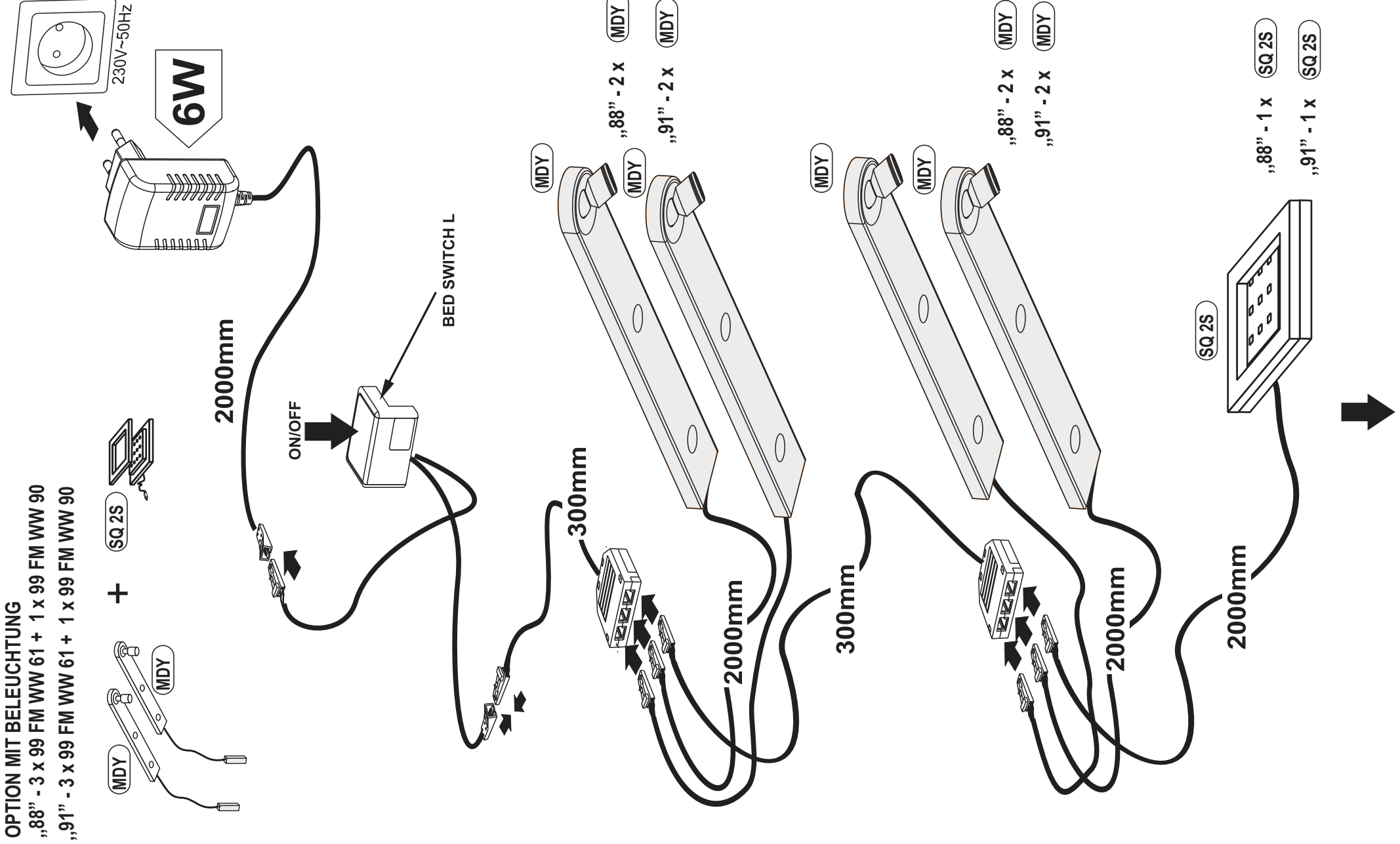

OPTION MIT BELEUCHTUNG

- „88“ - 3 x 99 FM WW 61 + 1 x 99 FM WW 90
- „91“ - 3 x 99 FM WW 61 + 1 x 99 FM WW 90



+ SQ 2S

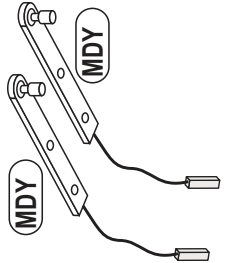

6W

2000mm

ON/OFF

BED SWITCH L

300mm

2000mm

300mm

2000mm

2000mm

SQ 2S

„88“ - 1 x

(SQ 2S)

„91“ - 1 x

(SQ 2S)

10

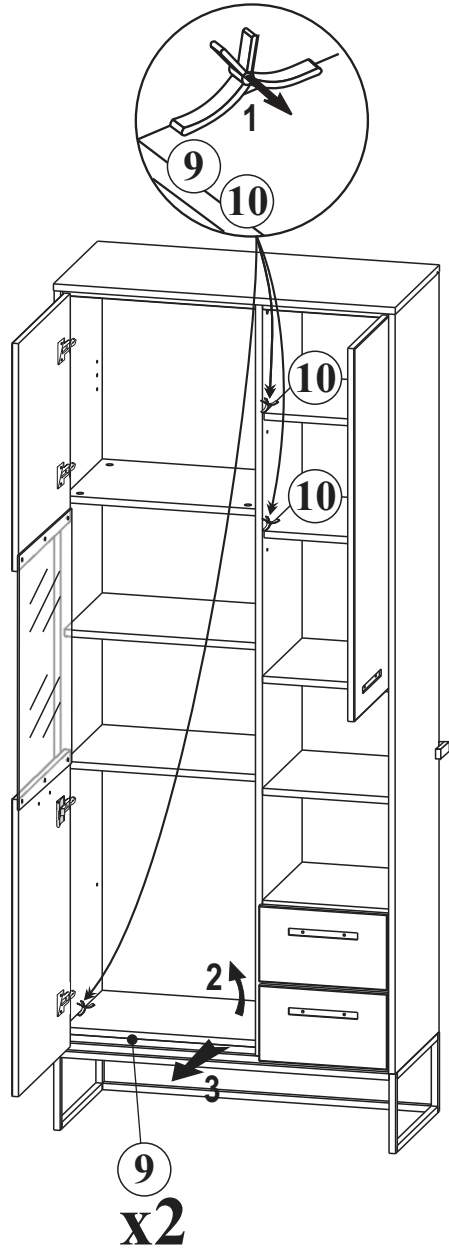

11

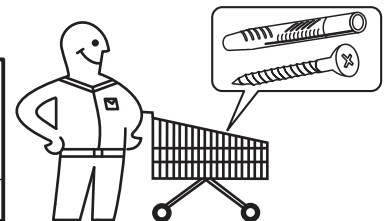
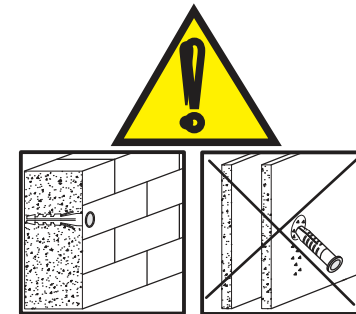
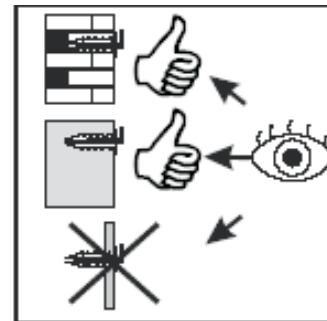
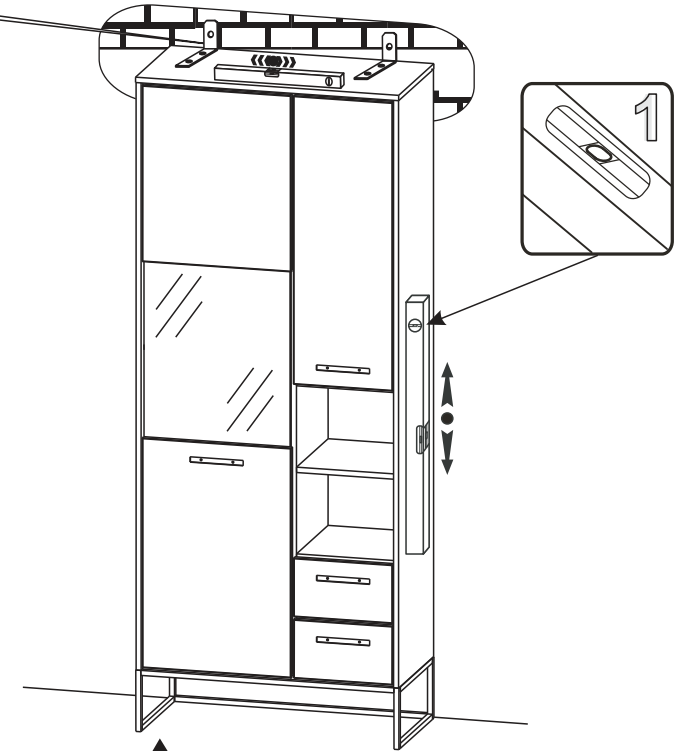
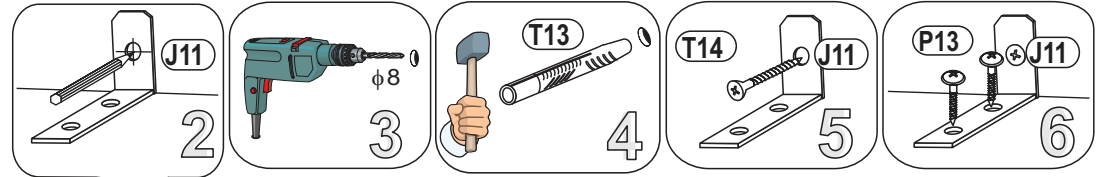
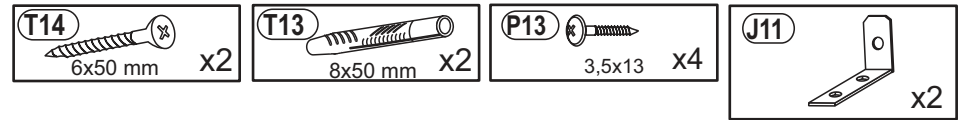

12

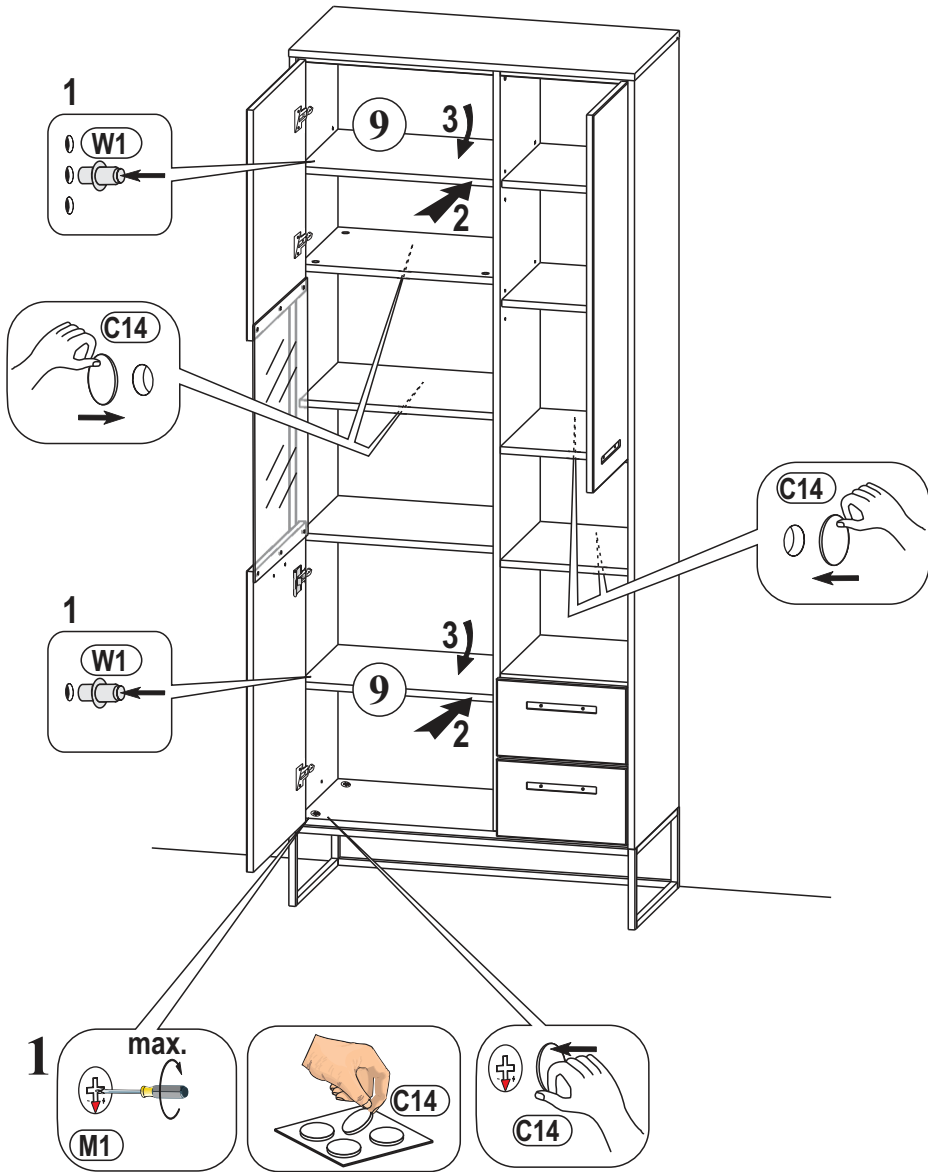
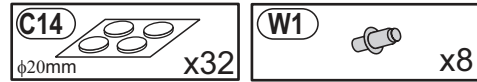

13

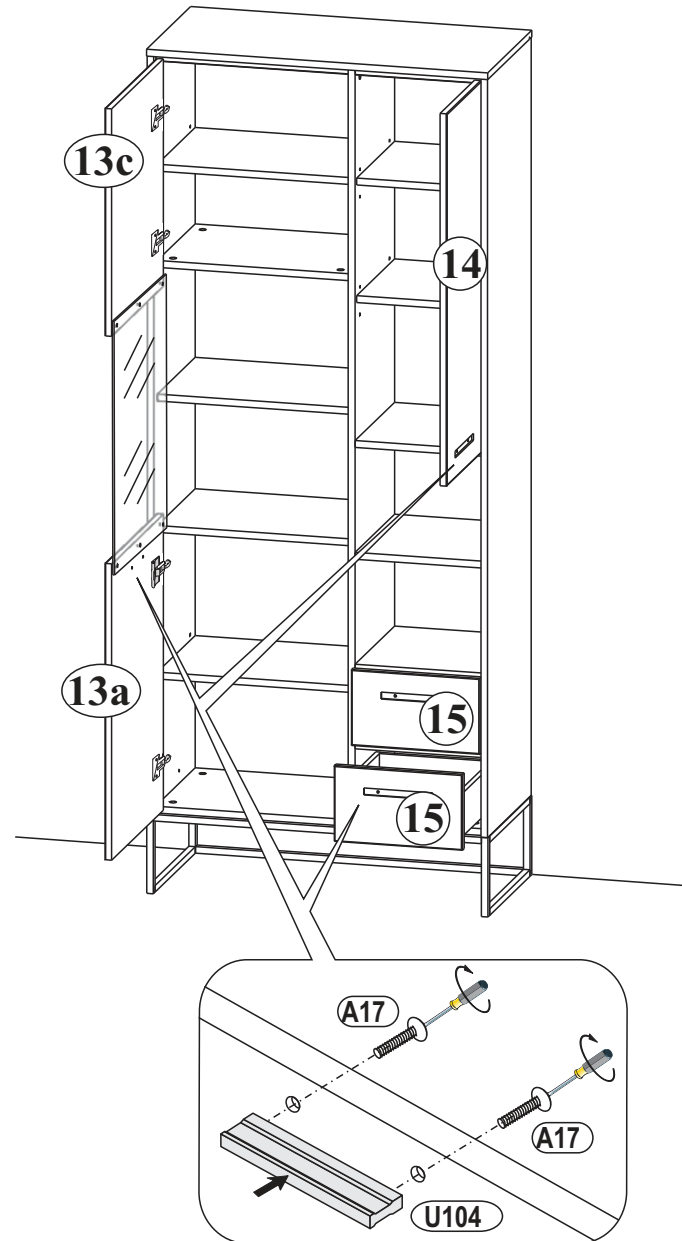

14

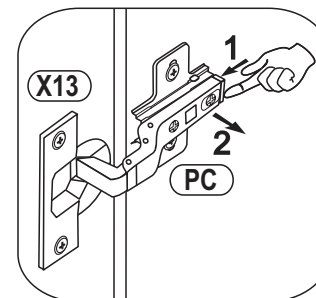
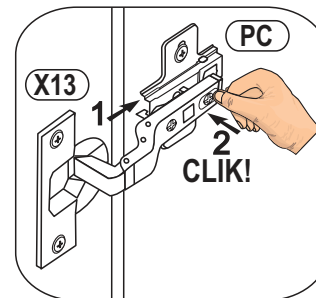
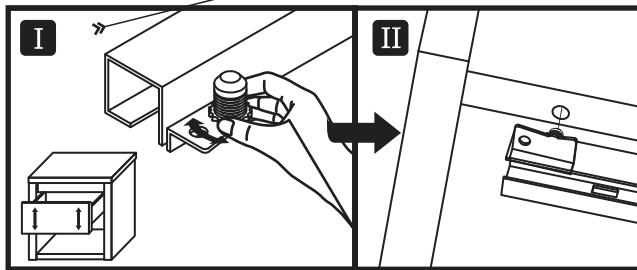
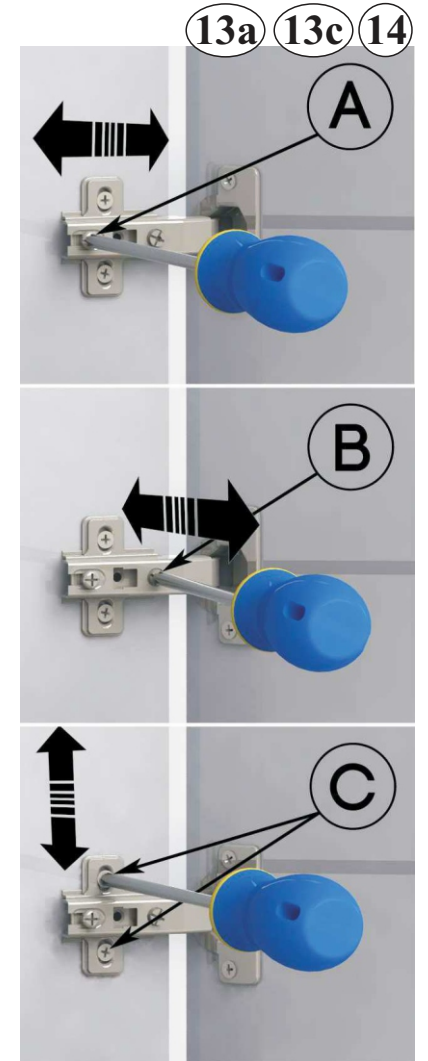
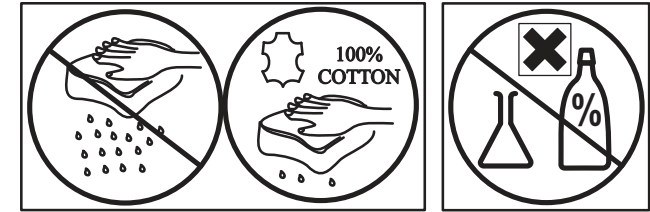
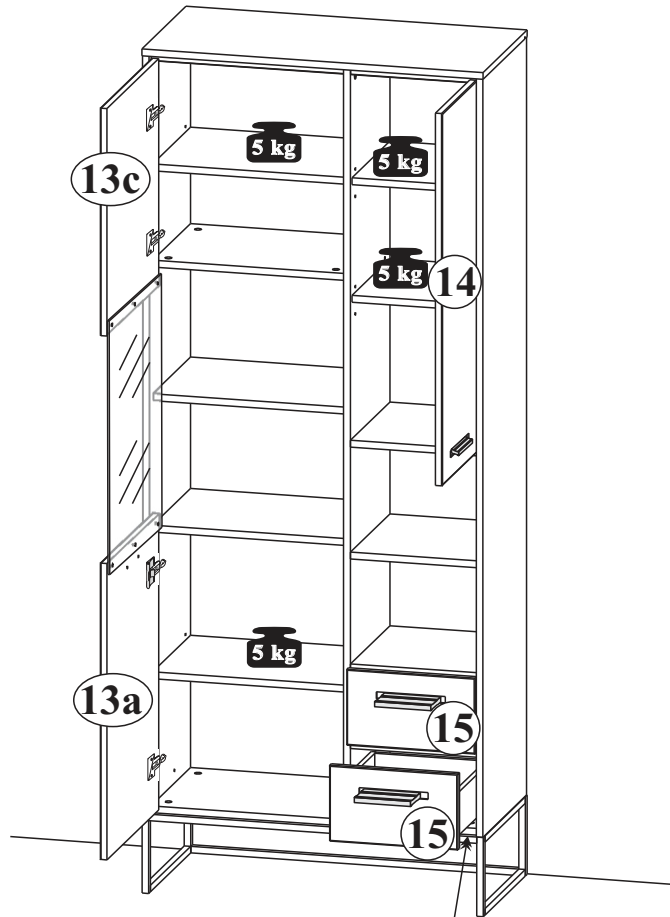

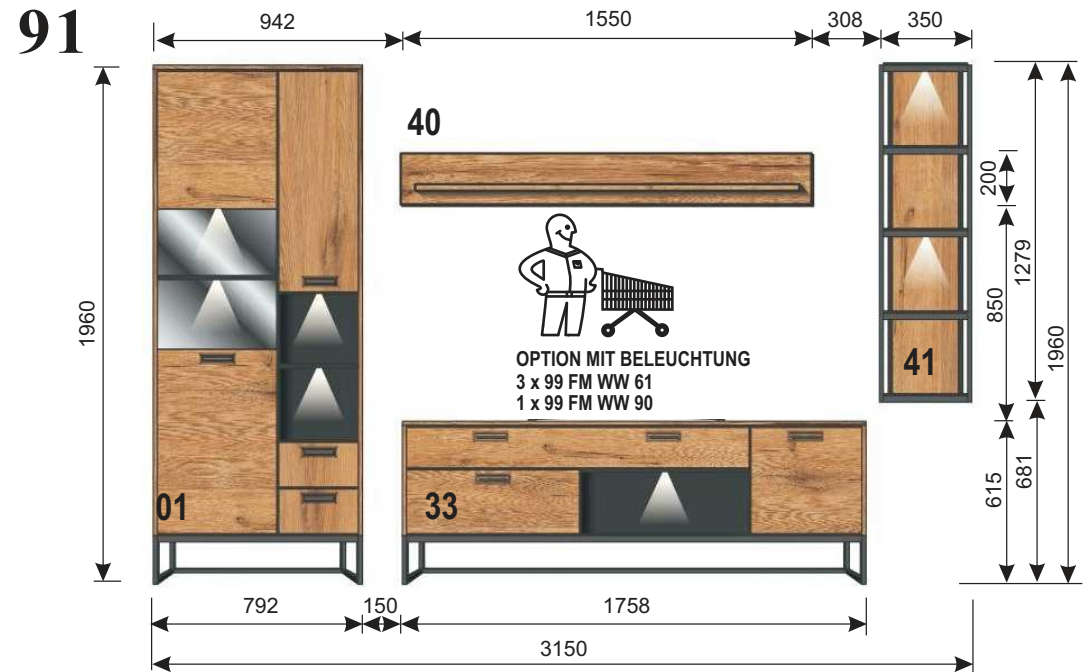
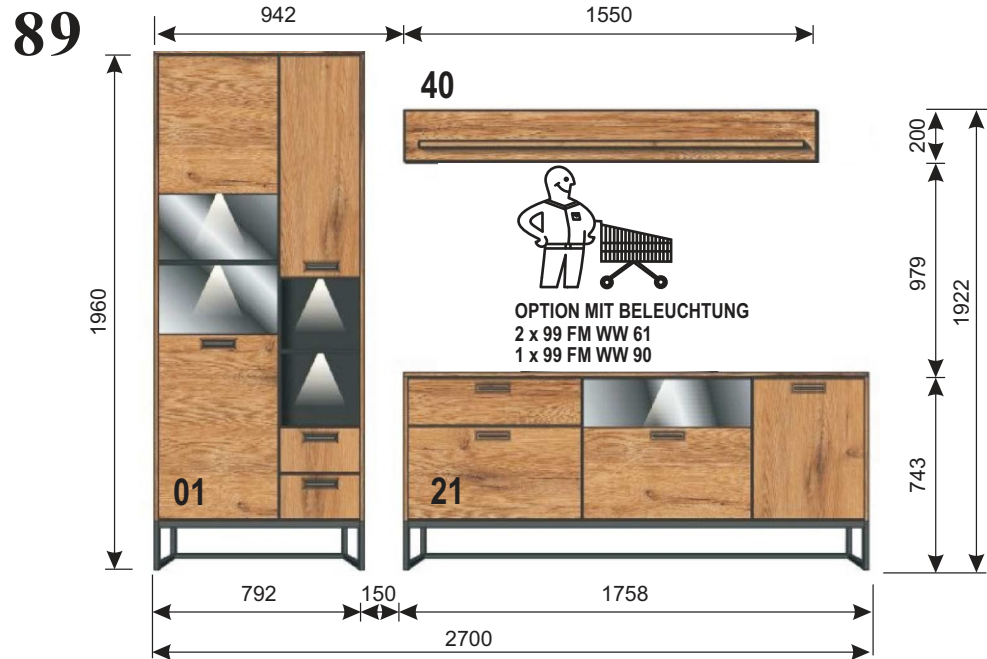
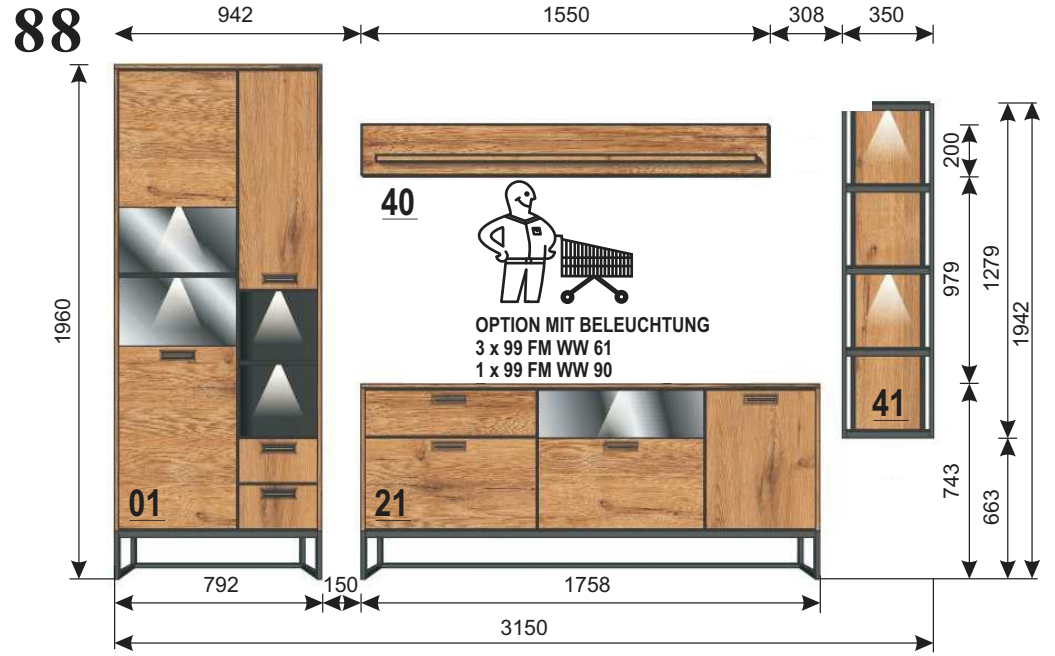
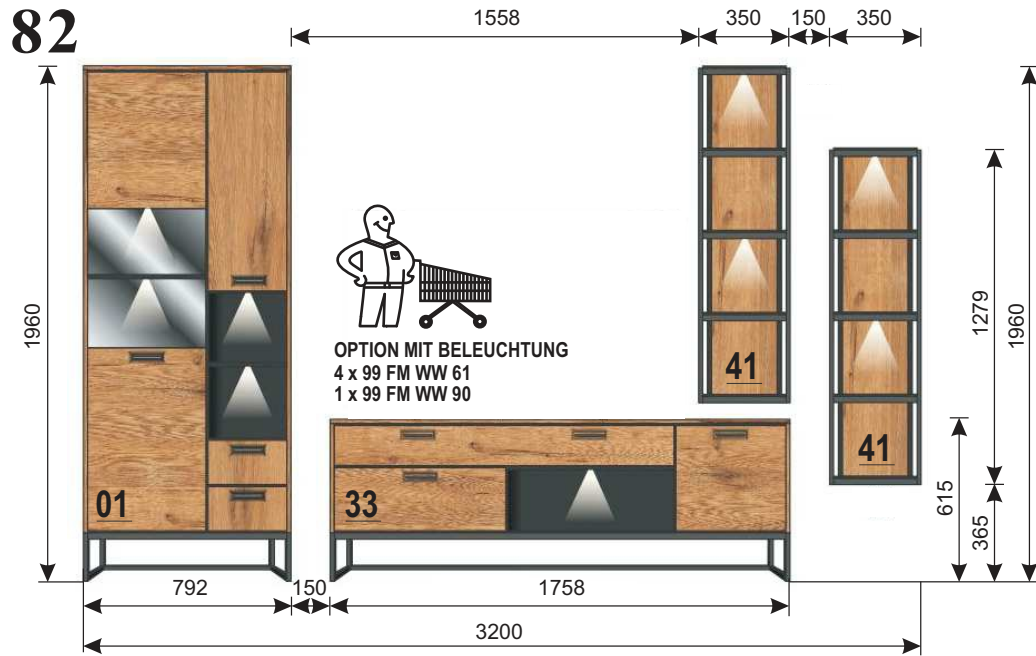

D CH AT LI LU Kleintelle und Verpackungsfolien bei der Möbelmontage von Kindern fernhalten!
GB US Keep small parts and plastic film out of the reach of children!
FR BE NC Tenir les petites pièces et les films plastiques hors de la portée des enfants!
NL Hou de kleine onderdelen en de plastic folie uit de buurt van kinderen!
IT Tenere i componenti di piccole dimensioni e le pellicole di plastica fuori dalla portata dei bambini!
SI Malhin delov in embalažne folije pri montaži pohištva hranite izven dosega otrok!
XS HR BA Malje dijelove i foliju za pakovanje priklom montaže namještaja držite dalje od djece
HU Bútorészereket közbén a kis alkatrészek és a csomagoló fóliák gyermekéktől távol tartandók!
BG Дребни детайли и опаковъчни фолиа да се държат далеч от деца при монтажа на мебелите!
CZ SK Dřevní detaily i fólii za balení držte dále od dětí při montáži nábytku
SE Vid möbelförpackning ska smådelar och förpackningsfolien hållas oåtkomliga för barn!
RO Tineți departe de copii piesele mici și folia de ambalat la montarea mobiliei!
ES ¡Durante el montaje, mantenga alejados de los niños las piezas pequeñas y el material plástico de embalaje!

D CH AT LI LU Möbelmontage muss auf ebennem Untergrund erfolgen. Bei Wandmontagen immer geeignetes Befestigungsmaterial verwenden.
GB US Furniture must be assembled on a flat surface. For assembly to the wall only use suitable fixing materials.
FR BE NC Le meuble doit être monté sur une surface plane. Pour le montage mural, utilisez des accessoires de fixation adaptés au type de mur.
NL De meubels dienen op een vlakke ondergrond te worden gemonteerd. Voor wandmontage moeten geschikte bevestigingsmaterialen worden gebruikt.
IT Il montaggio dei mobili deve avvenire su un fondo piano. Per il montaggio si prega di utilizzare solo materiali adatti.
SI Pohištvo je treba montirati na ravni podlagi. Pri stenski montaži vedno uporabite pritrilivni material.
XS HR BA Namještaj se mora montirati na ravnoj podlozi. Kod montaže na zid uvijek koristite prikladan materijal za pričvršćivanje.
HU A bútorcszerelési silk felületen kell végezni. Falra szereléshez mindig megfelelő rögzítianyagot kell használni.
BG Монтажът на мебелите да се извършва на равна основа. При стенен монтаж винаги да се използва подходящ крепежен материал.
CZ SK Montáž nábytku provádějte na rovném podkladu. Při montáži na stěnu používejte vždy vhodný příslušovací materiál.
SE Monterिंग av möbeln måste göras på jämnt underlag. Vid väggmontering ska lämpligt uppfästingsmaterial användas.
RO Montarea mobiliei trebuie să se realizeze pe o pardoseală dreaptă. La montarea la perete utilizați întotdeauna material de fixare adecvat.
ES El montaje debe efectuarse sobre una superficie uniforme. En el montaje mural emplee siempre el material de fijación adecuado.

D CH AT LI LU Bitte beachten Sie die Montageanleitung. Halten Sie immer die angegebene Wattzahl ein. Verhindern Sie einen Hitzestau.
GB US Please observe the assembly instructions. Do not exceed the max. given wattage. Ensure that the heat is not allowed to build up.
FR BE NC Veuillez respecter la notice de montage. Respectez impérativement le nombre des watts maximal. Veillez à éviter toute accumulation de chaleur.
NL Lees a.u.b. de montagehandleiding door. Hou de beslist aan het max. opgegeven wattage. Zorg ervoor dat geen hittehuizing onstaat.
IT Attenersi alle istruzioni di montaggio. Rispettarsi rigorosamente il numero di watt max. indicato. Assicurarsi che non si verifichi un accumulo di calore.
SI Upoštevajte navodila za montažo. Vedno upoštevajte navedeno število vatov. Preprečite zastoj vročine.
XS HR BA Obratite pažnju! Vas pozor na uputu za montažu. Uvijek se pridržavajte navedenog broja vai. Izbjegavajte zastoj vrućine.
HU Vegye figyelembe a szerelési útmutatót. Mindig tartsa be a megadott wattszámot. Akadályozza meg a hőelődést.
BG Моля, вземете под внимание ръководството за монтаж. Спазвайте винаги посочените ватове. Избягвайте акумулиране на топлина.
CZ SK Dodržujte prosím návod k montáži. Vždy dodržujte uvedenou hodnotu výkonu (watt). Zabráňte tak přehřívání.
SE Följ monteringsanvisningen. Följ alltid angivet watttal. Undvik att hetta uppstår.
RO Respectați instrucțiunile de montaj. Respectați întotdeauna numărul de watt impus. Evitați acumularea de căldură.
ES Le rogamos que tenga presente las instrucciones de montaje. Respete siempre el número indicado de vatios. Evite la acumulación de calor.

D CH AT LI LU Halten Sie die max. zulässigen Belastungswerte der Möbelteile ein. Details siehe Montageanleitung
GB US Comply with the max. permissible loads. For details, please refer to the assembly instructions
FR BE NC Respectez les valeurs de charge max. admissibles des parties de meubles. Pour plus de détails, cf. la notice de
NL Hou de maximaal geoorloofde belastingwaarden van de meubeldelen aan. Voor details verwijzen wij naar de montagehandleiding
IT Rispettare la portata max. permessa degli elementi del mobile. Per dettagli si vedano le istruzioni di montaggio e si vada
SI Upoštevajte največjo dovoljeno obremenitev delov pohištva. Podrobnosti najdete v navodilih za montažo in na
XS HR BA Tarta da ve a bitorelemek max. megdondeti terhetési értéket. A részleteket lásd a szerelési útmutatóban
HU Tartassa be a bitorelemek max. megengedett terhelési értékeit. A részleteket lásd a szerelési útmutatóban
BG Спазвайте макс. допустимите стойности на натоварване на мебелите. За подробности виж ръководството за монтаж
CZ SK Dodržujte max. přípustné hodnoty zatížení nábytkových dílů. Podrobnosti viz návod k montáži
SE Följ max. tillåten belastning av möbeldelarna. Mer information finns i monteringsanvisningen
RO Respectați valorile de solicitare max. admise pentru corpurile de mobilier. Pentru detalii consultați instrucțiunile de montaj
ES Respete los valores máximos de carga admisibles para las piezas de los muebles. Consulte los detalles en las instrucciones

D CH AT LI LU Zur Möbelfreinigung ein mit Wasser befeuchtetes, fusselfreies Baumwolltuch verwenden. Geeignigte Flächen immer trockenreiben!
GB US To clean the furniture only use a water dampened lint-free cotton cloth. Once cleaned, always wipe the surfaces dry.
FR BE NC Utilisez un chiffon en coton non pelucheux humidifié avec de l'eau pour nettoyer les meubles. Séchez systématiquement les surfaces
NL nettooyes en les frottant!
IT Gebrüik een met water bevochtigde, pluïsvrije katoenen doek om de meubels te reinigen. Wrijf gereinigde oppervlakken altijd droog!
SI Per pulire il mobile utilizzare un panno di cotone inumidito d'acqua e che non perde pelucchi. Asciugare sempre le superfici che si sono
XS HR BA kuiteli.
HU Za čišćenje pohištva uporabljajte vlažno bombažno krpo, ki ne pušča vlaken. Očiščene površine vedno obrišite do suhlega
BG Za čišćenje namještaja koristite sa vodom navlaženu pamučnu krpu koja ne ispušta vlakna. Očišćene površine uvijek obrišite suhom
CZ SK K čištění nábytku používejte bavlněný hadr neuvloňující vlákna, navlhčený ve vodě. Učištěné plochy vždy utřete do sucha!
SE För möbelförpackning används en luddfri bomullsduk fuktad med vatten. Rengjorda ytor ska alltid torflas torra!
RO Pentru curățarea mobiliei utilizați o lavetă din bumbac fără scame umezită cu apă. Suprafețele curățate se șterg întotdeauna până se
ES Emplee un paño de algodón humedecido con agua y libre de pelusa para la limpieza de los muebles. ¡Seque siempre las superficies que ha limpiado!