

LOFT-TWO

S616-PAN

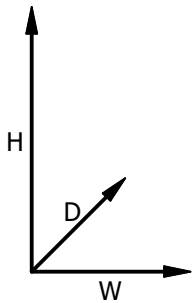

H - 928 mm
W - 1970 mm
D - 238 mm

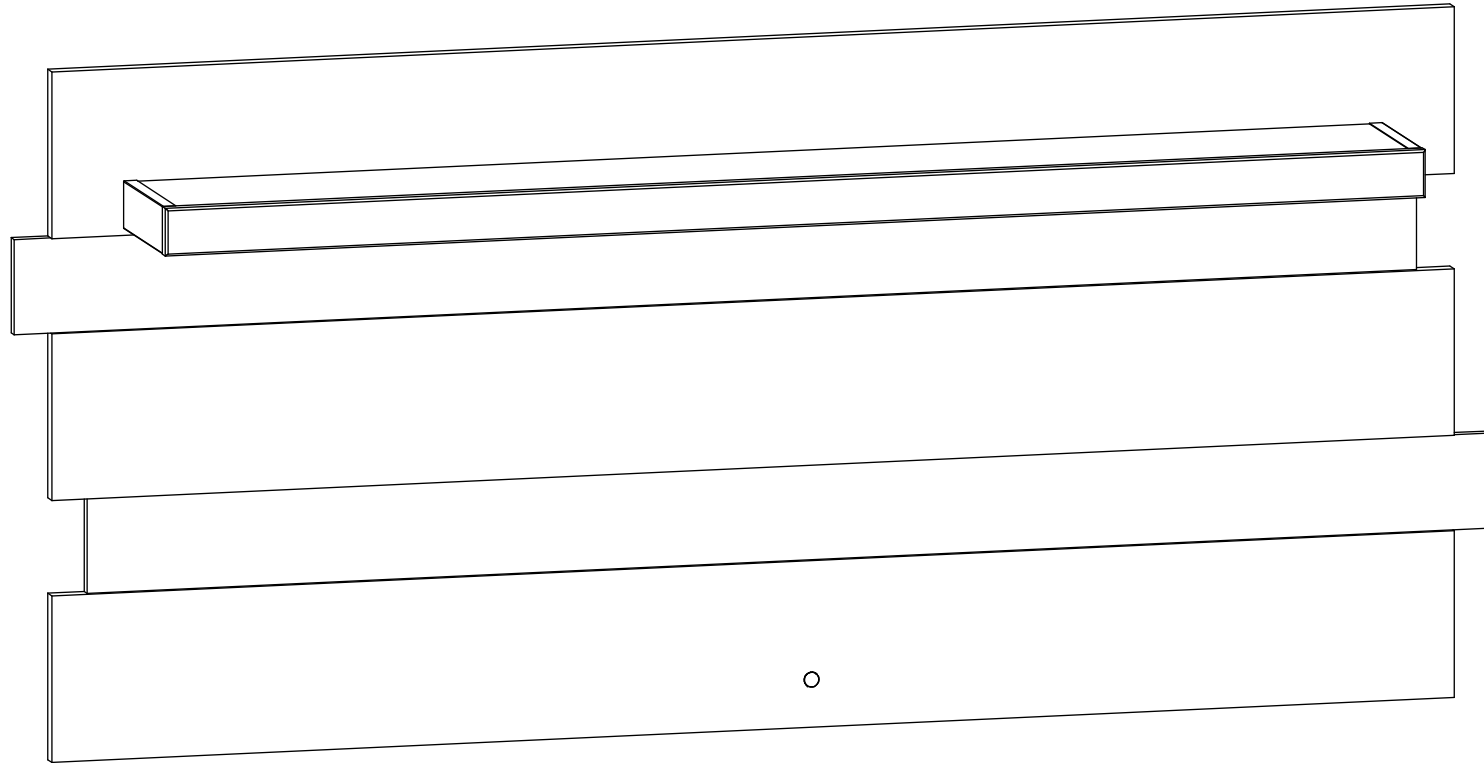
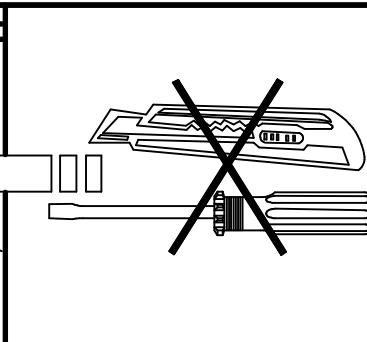
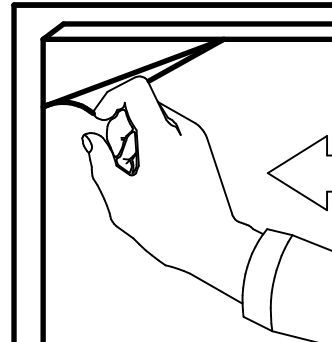
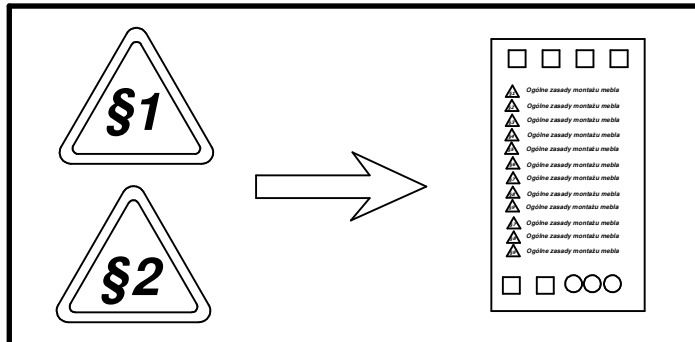
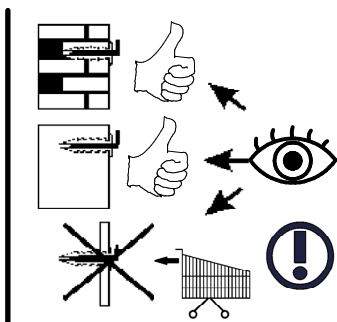
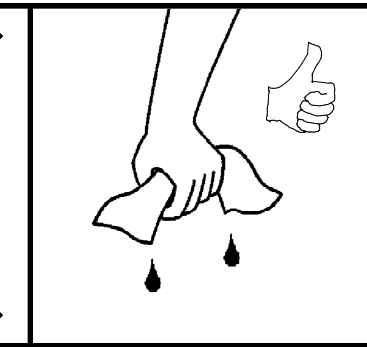
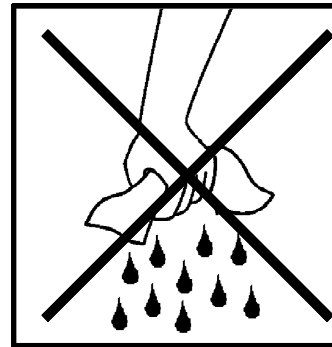
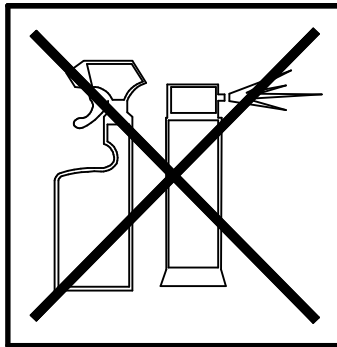
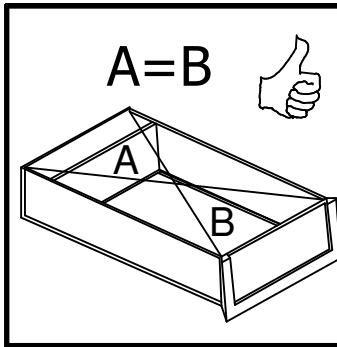
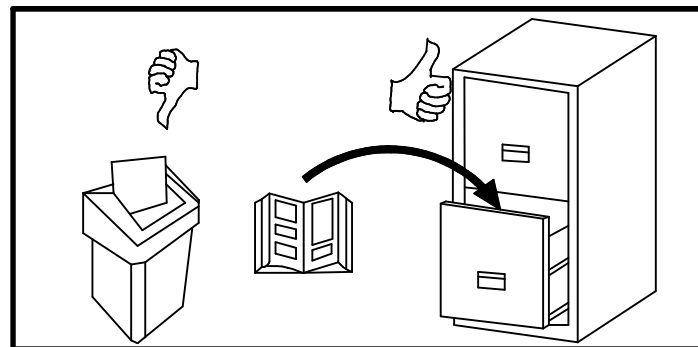
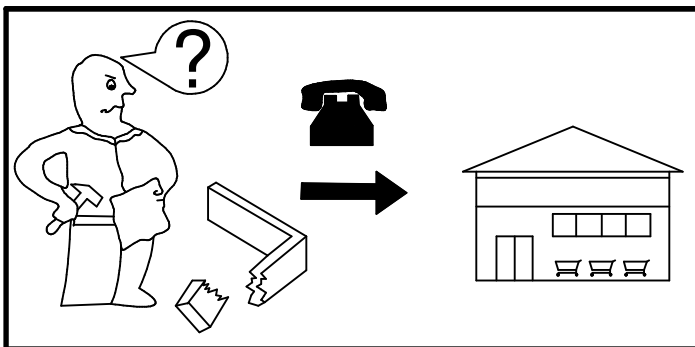
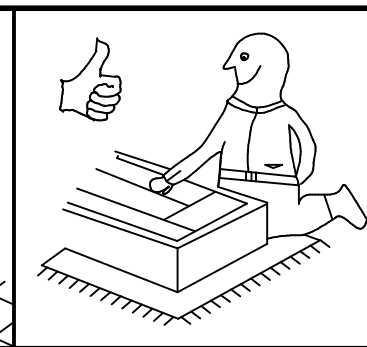
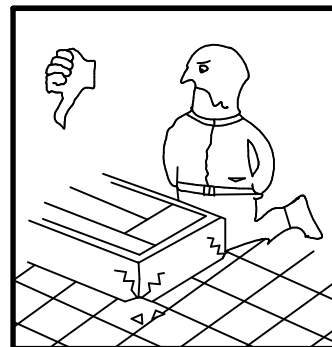
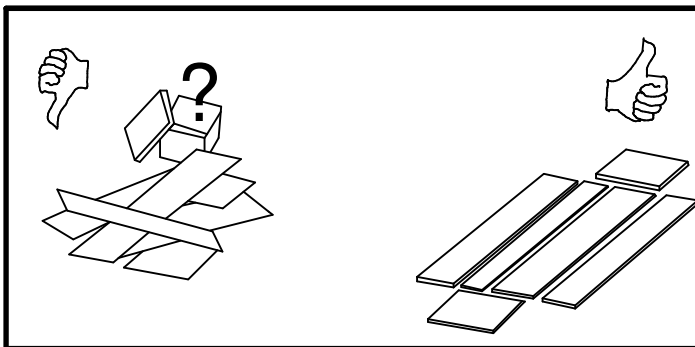
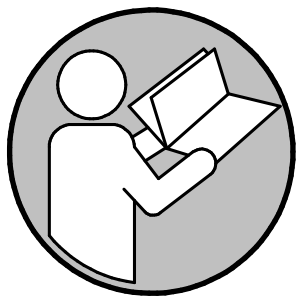

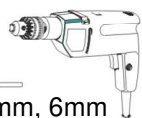
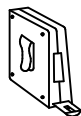
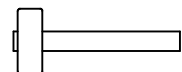
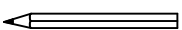
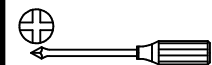
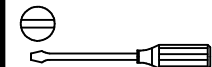
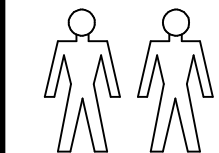

Ø 10mm, 6mm

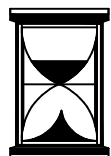

60 min

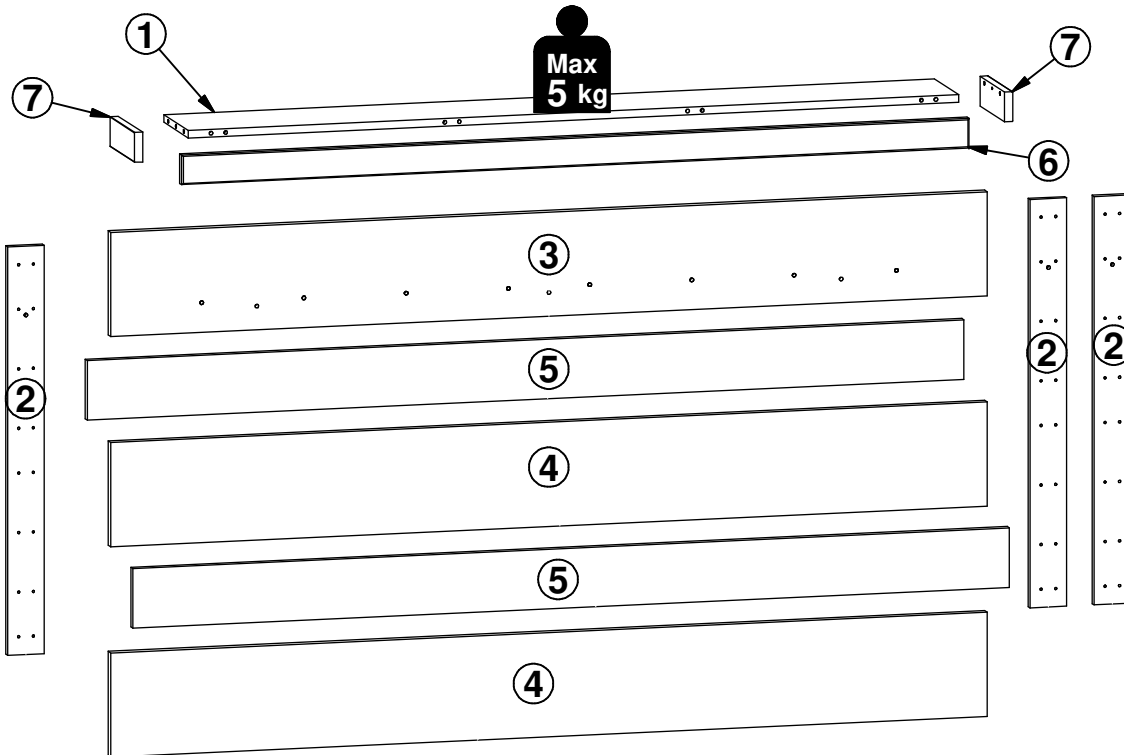

A	B	C (mm)			D
1	S616-3027	1688	200	16	1/1
2	S616-4006	878	80	16	1/1
3	S616-4007	1920	224	22	1/1
4	S616-4009	1920	224	22	1/1
5	S616-4010	1920	128	16	1/1
6	S616-5011	1725	64	18	1/1
7	S616-5012	200	64	18	1/1



D
1/1

6x Ø5x11 mm e4	8x Ø7x70 mm e27	8x Ø8x30 mm f1	4x Ø10x50 mm f35	3x g2	1x o80/3	1x 12V-6W o75/2	3x LED 54x54 mm o86/1	3x o86/2	48x Ø4x25 mm p8	3x Ø6x60 mm p75	6x Ø2x8 mm p123	1x Ø5x70 mm p135
6x Ø15x12 mm #16 r1	6x r42	7x Ø 20mm s68	6x Ø12,7x1,8 mm s104	1x 4 mm z1								

1 

I

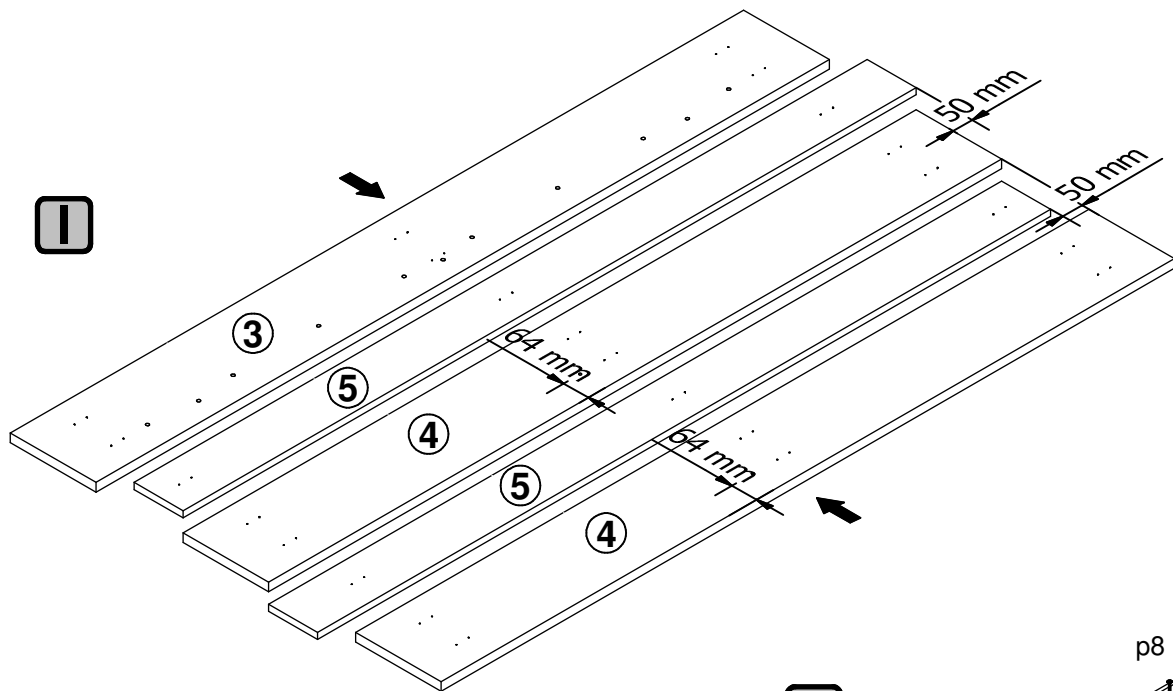

III

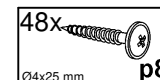
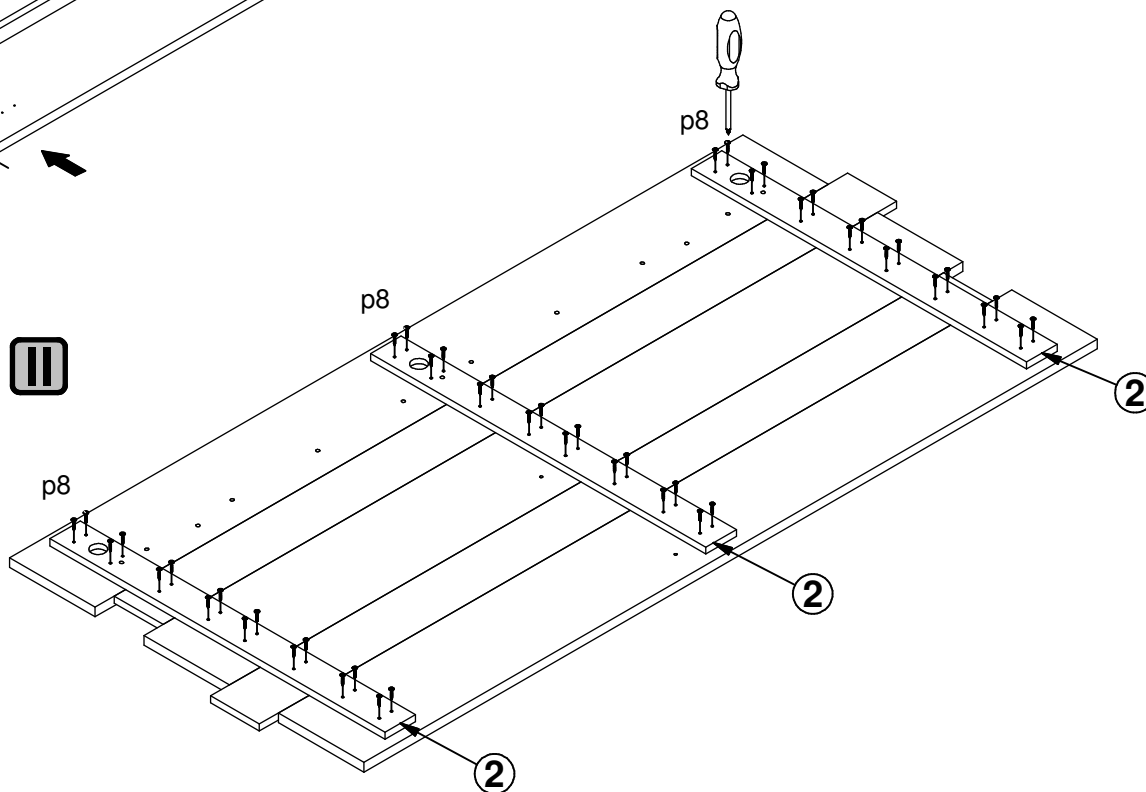

2 §6

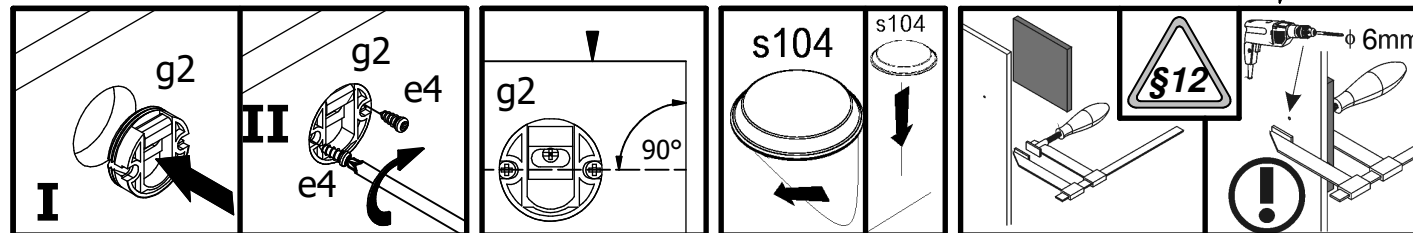
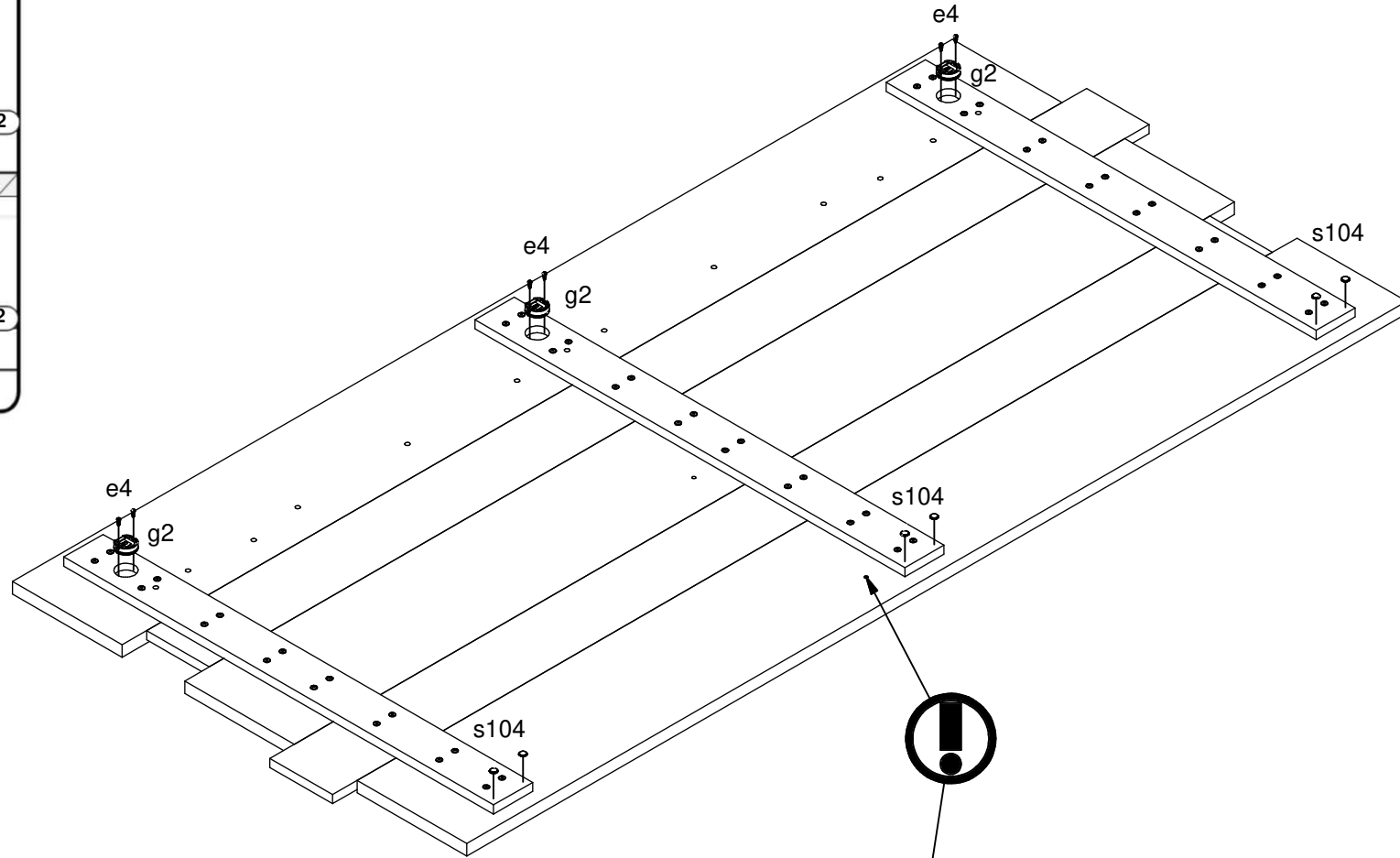
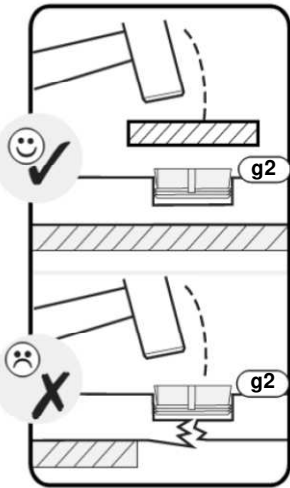



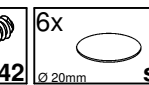
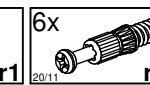
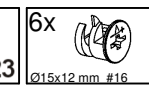
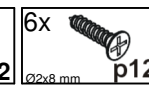
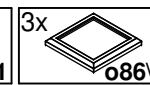
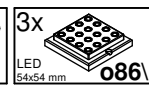
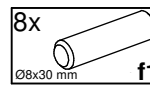
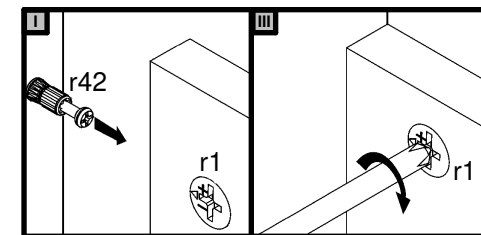
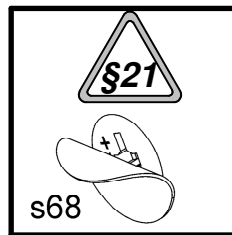
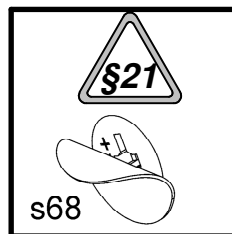
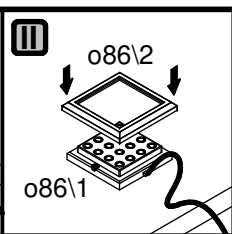
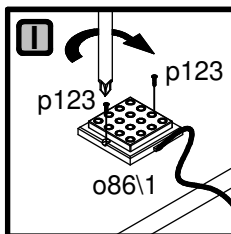
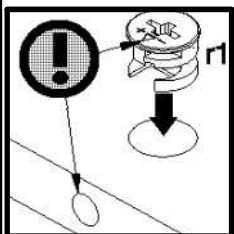
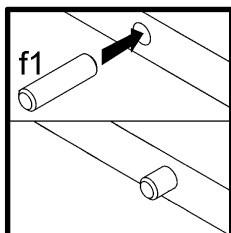
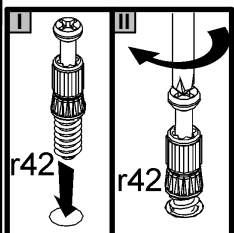
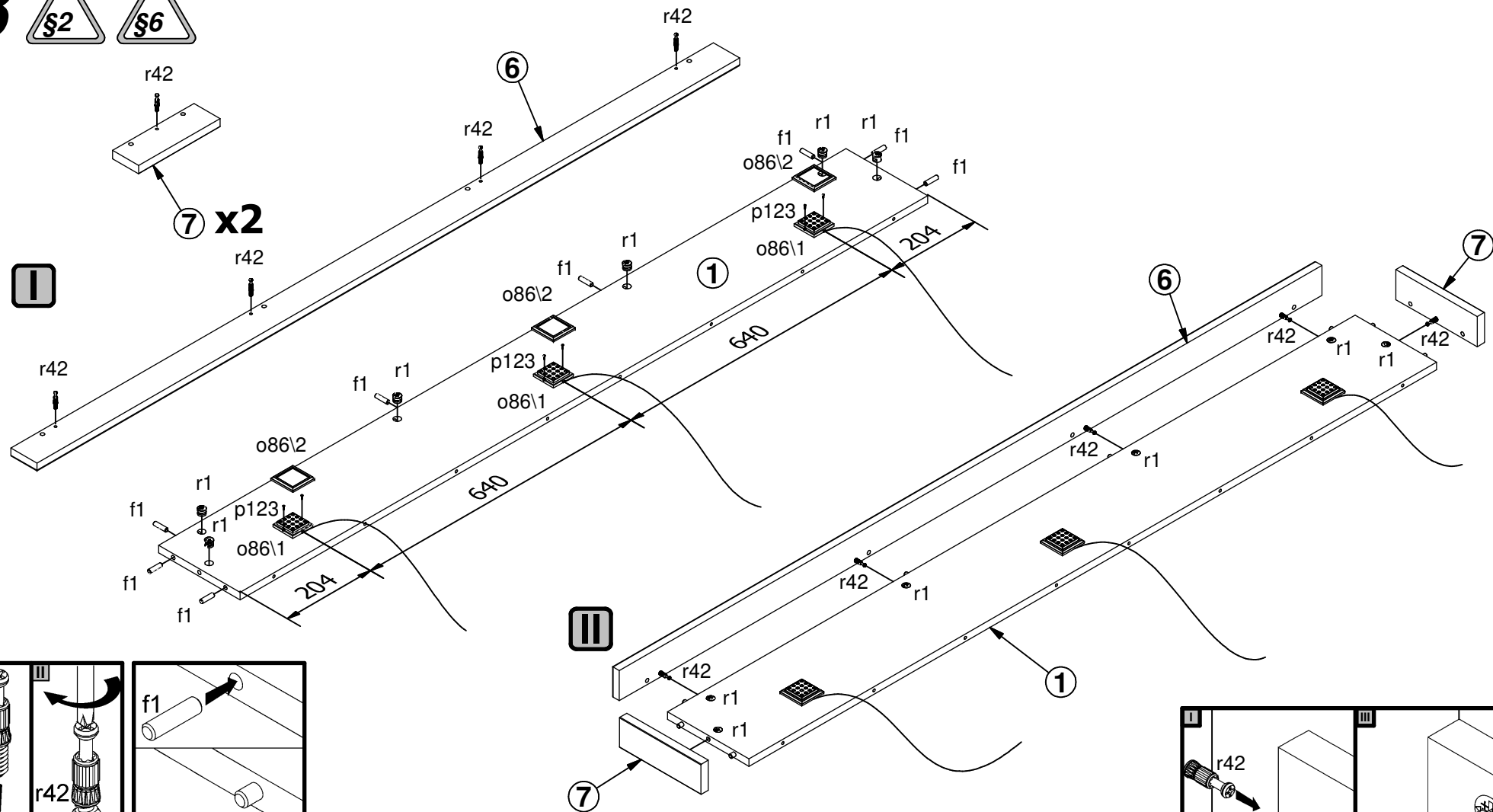

3

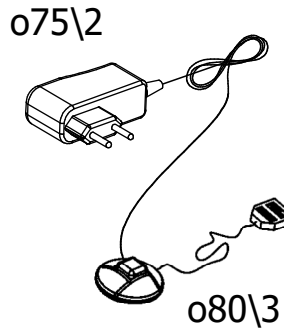
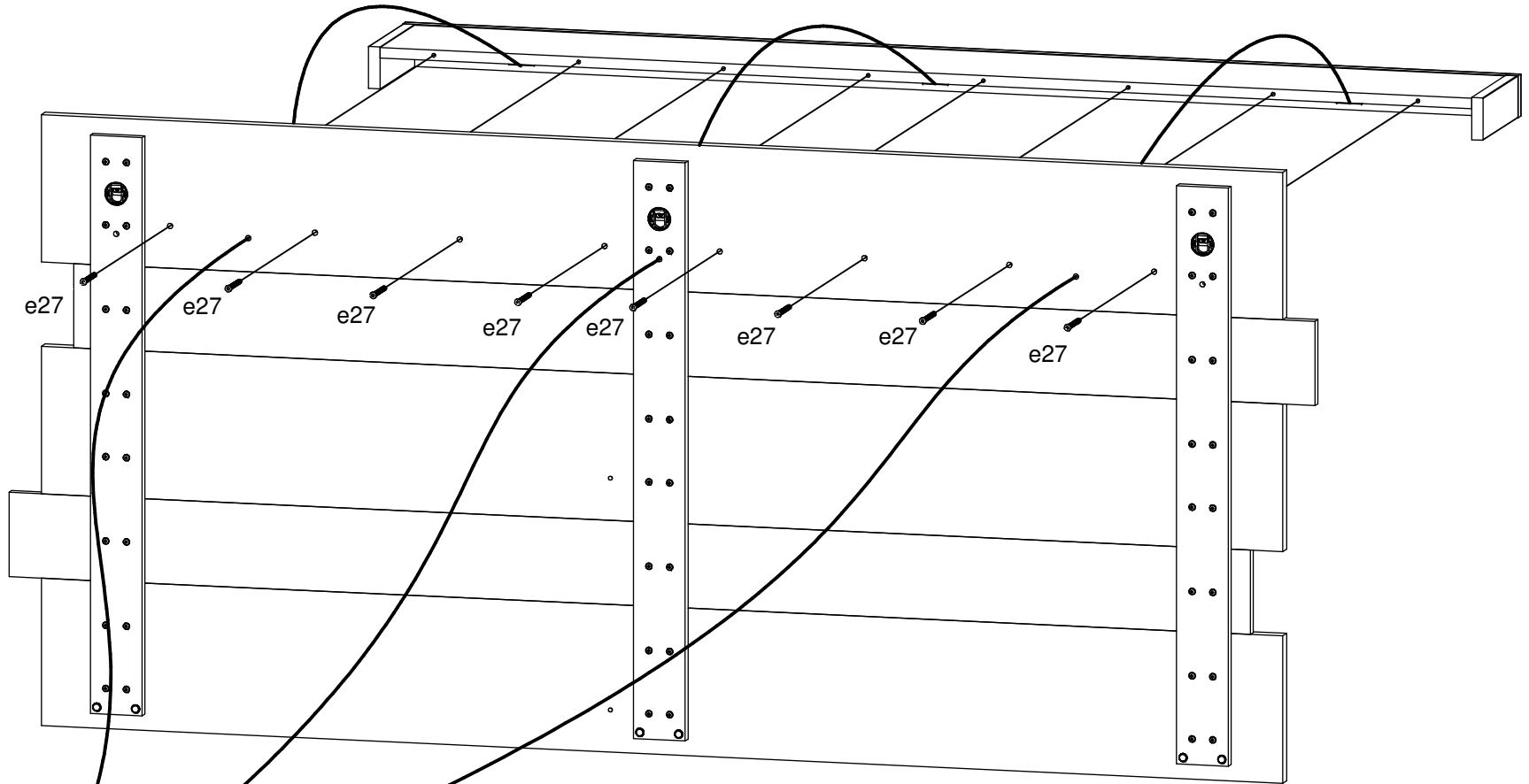
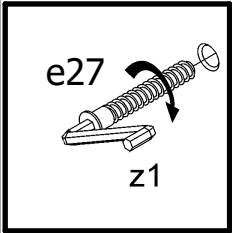

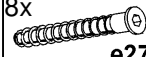
4 



- | | | | |
|--|--|--|---|
| 8x

e27
Ø7x70 mm | 1x

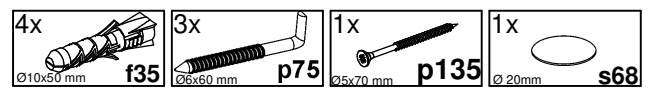
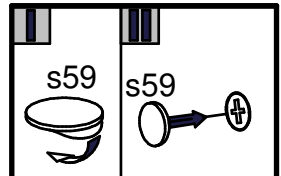
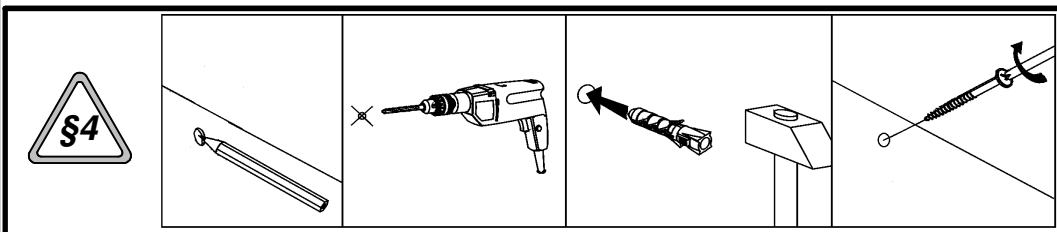
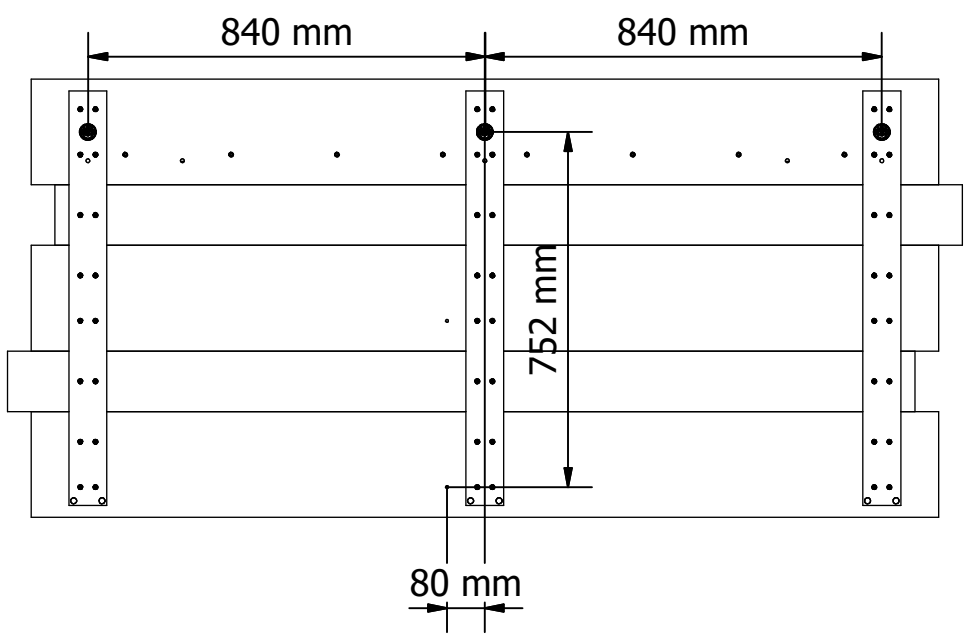
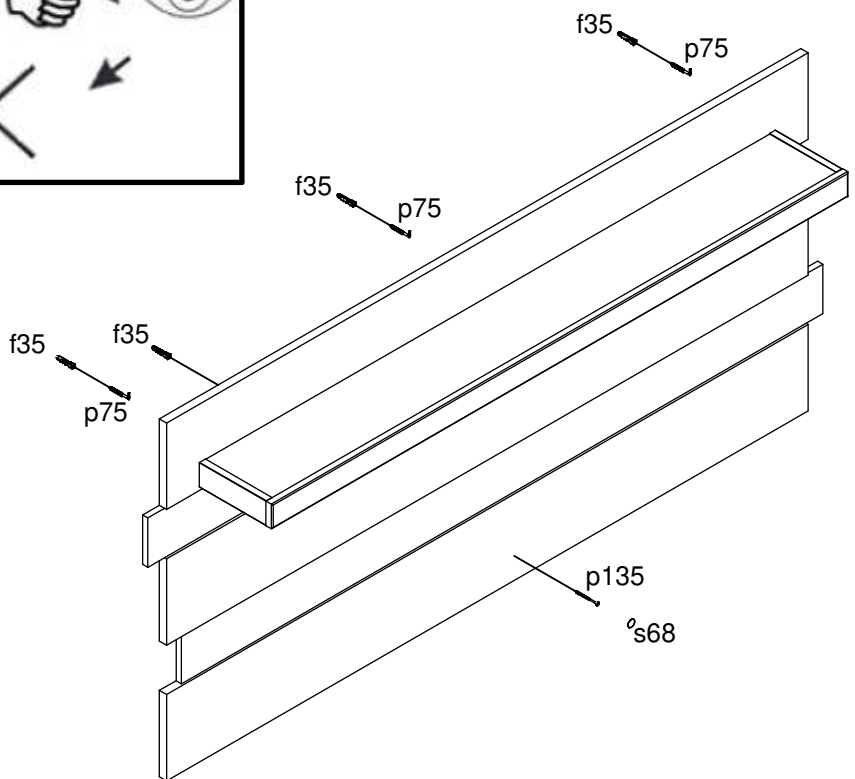
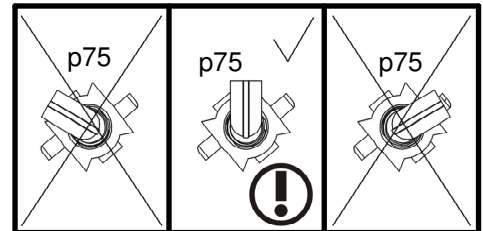
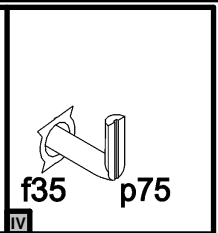
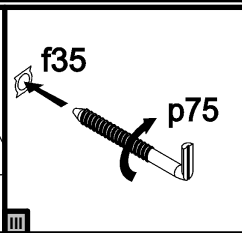
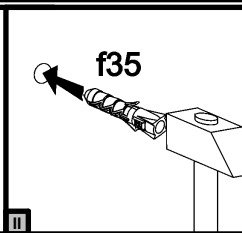
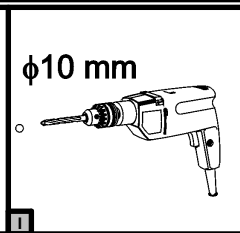
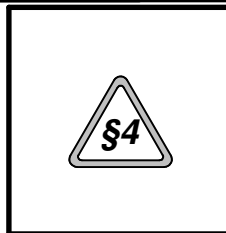
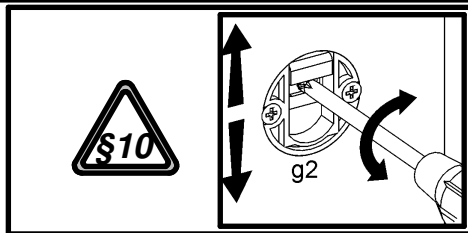
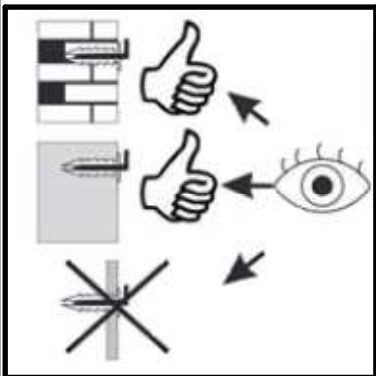
o80\3 | 1x

o75\2
12V-6W | 1x

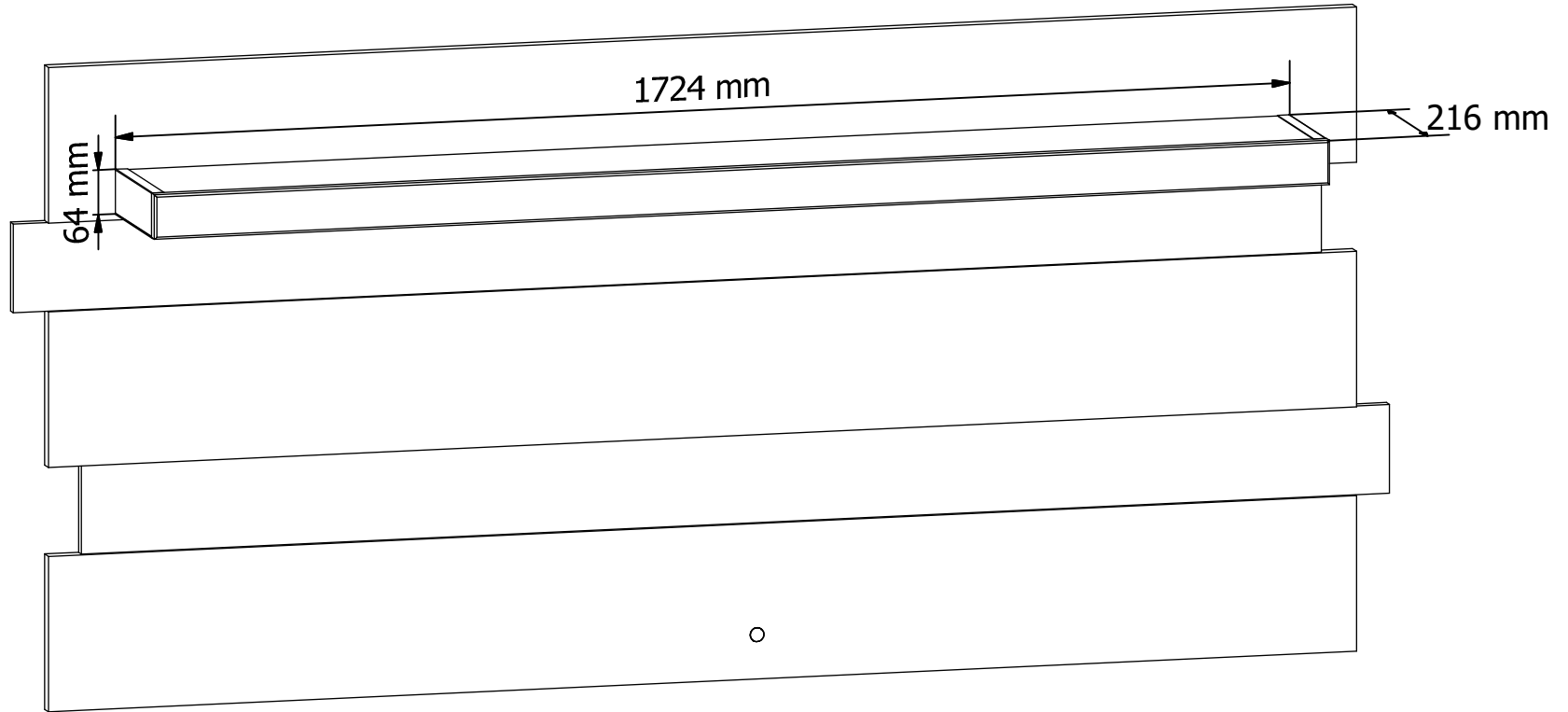
z1
4 mm |
|--|--|--|---|

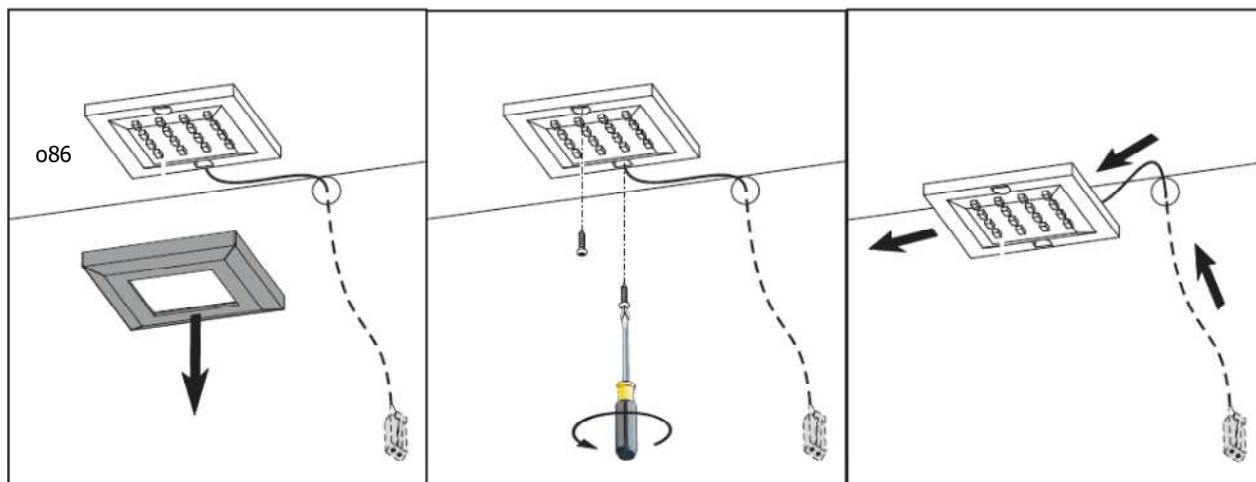
5 §6



6





787846 SQUARE2S-PCB-NW

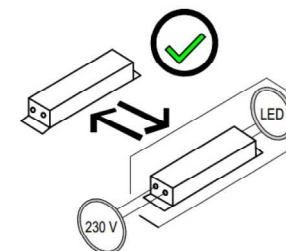
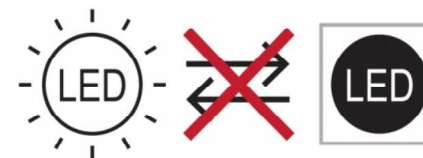

PL- Ten produkt zawiera źródła światła o klasie efektywności energetycznej „F”

DA- Dette produkt indeholder en lyskilde til energieffektivitetsklasse „F”

ES- Este producto contiene una fuente de luz de clase de eficiencia energética „F”

FR- Ce produit contient des sources lumineuses de classe d'efficacité „F”

LT- Šiame gaminyje yra energijos vartojimo efektyvumo klasės šviesos šaltinis „F”

PT- Este produto contém uma fonte de luz da classe de eficiência energética „F”

SK- Tento výrobok obsahuje svetelný zdroj triedy energetickej účinnosti „F”

TR- Bu ürün bir ışık kaynağı enerji verimliliği sınıfı içerir „F”

DE- Diese Produkte enthalten Lichtquellen der Energieeffizienzklasse „F”

EL- Αυτό το προϊόν περιέχει μια πηγή φωτεινής πηγής ενεργειακ ής απόδοσης „F”

ET- See toode sisaldab efektiivsusklassi valgusallikat energia " „F”

HU- Ez a termék energiahatékonysági osztályú fényforrást tartalmaz „F”

LV- Šis produkts satur gaismas avotu ar energoefektivitātes klasi „F”

RO- Acest produs conține o sursă de lumină de clasă de eficiență energetică „F”

SLO- Ta izdelek vsebuje svetlobni vir razreda energijske učinkovitosti „F”

HR- Ovaj proizvod sadrži izvor svjetlosti razreda energetske učinkovitosti „F”

CS- Tento výrobek obsahuje světelný zdroj třídy energetické účinnosti „F”

EN- This product contains a light sources of energy efficiency class „F”

FI- Tämä tuote sisältää energiatehokkuusluokan valonlähteen „F”

IT- Questo prodotto contiene una sorgente luminosa di classe di efficienza energetica „F”

RU- Этот продукт содержит источник света класса энергоэффективности „F”

NL- Dit product bevat een lichtbron met energie - efficiëntieklasse „F”

SV- Denna produkt innehåller en ljuskälla för energieffektivitetsklass „F”

BG- Този продукт съдържа източник на светлина от клас на енергийна ефективност „F”