

LOFT-TWO

S616-SFW1W

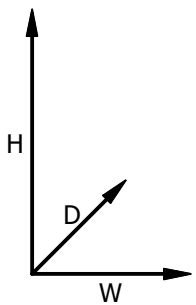

H - 1280 mm
W - 520mm
D - 370 mm

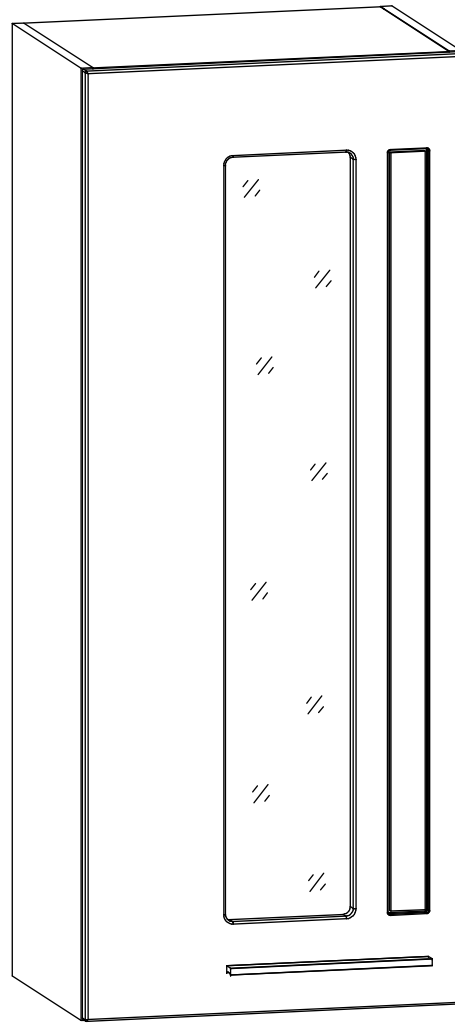
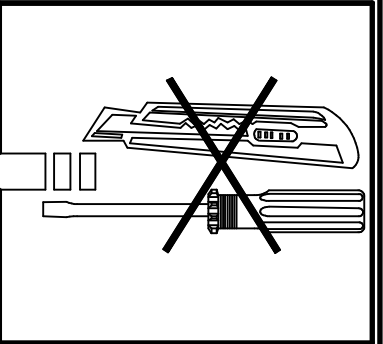
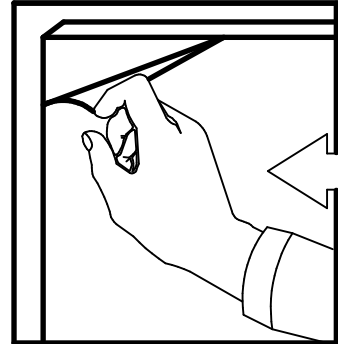
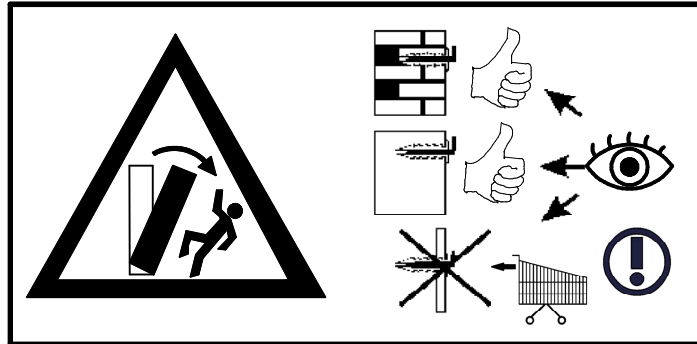
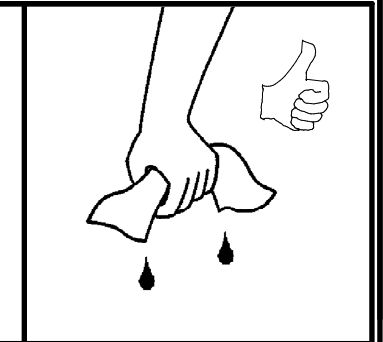
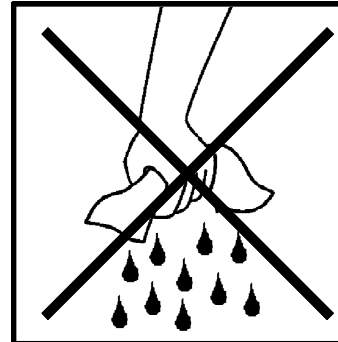
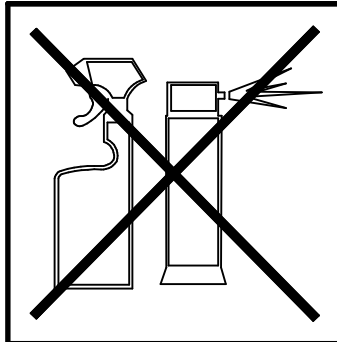
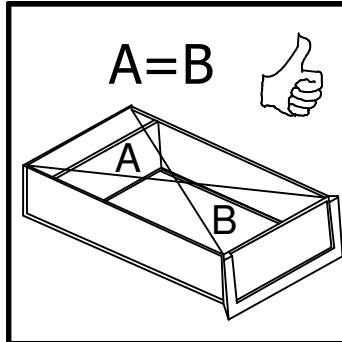
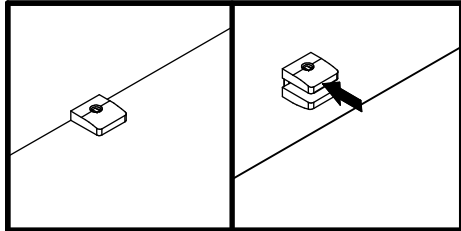
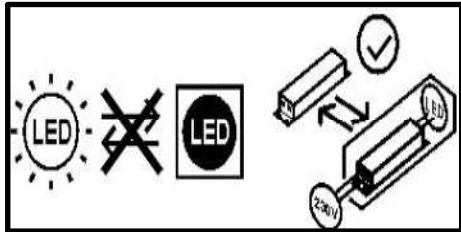
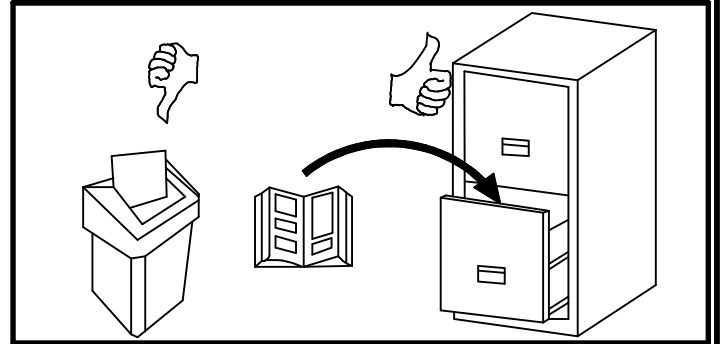
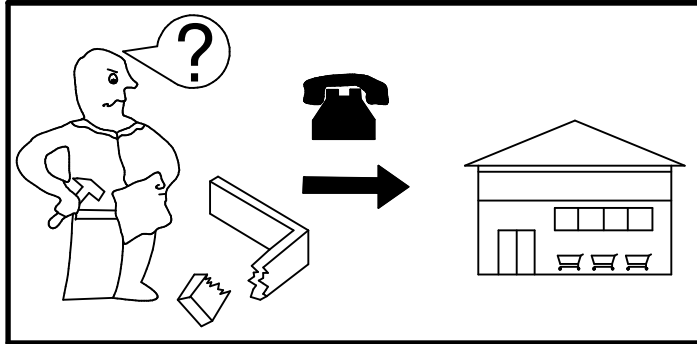
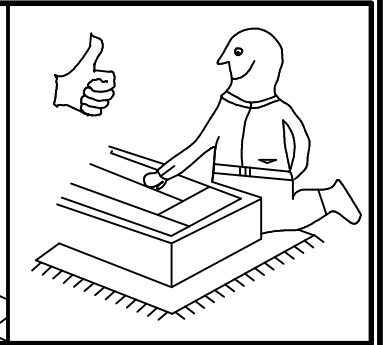
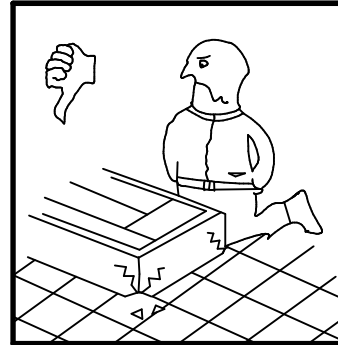
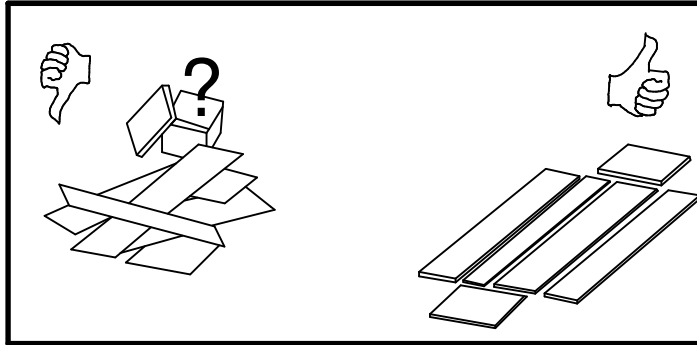
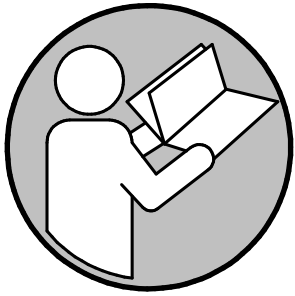

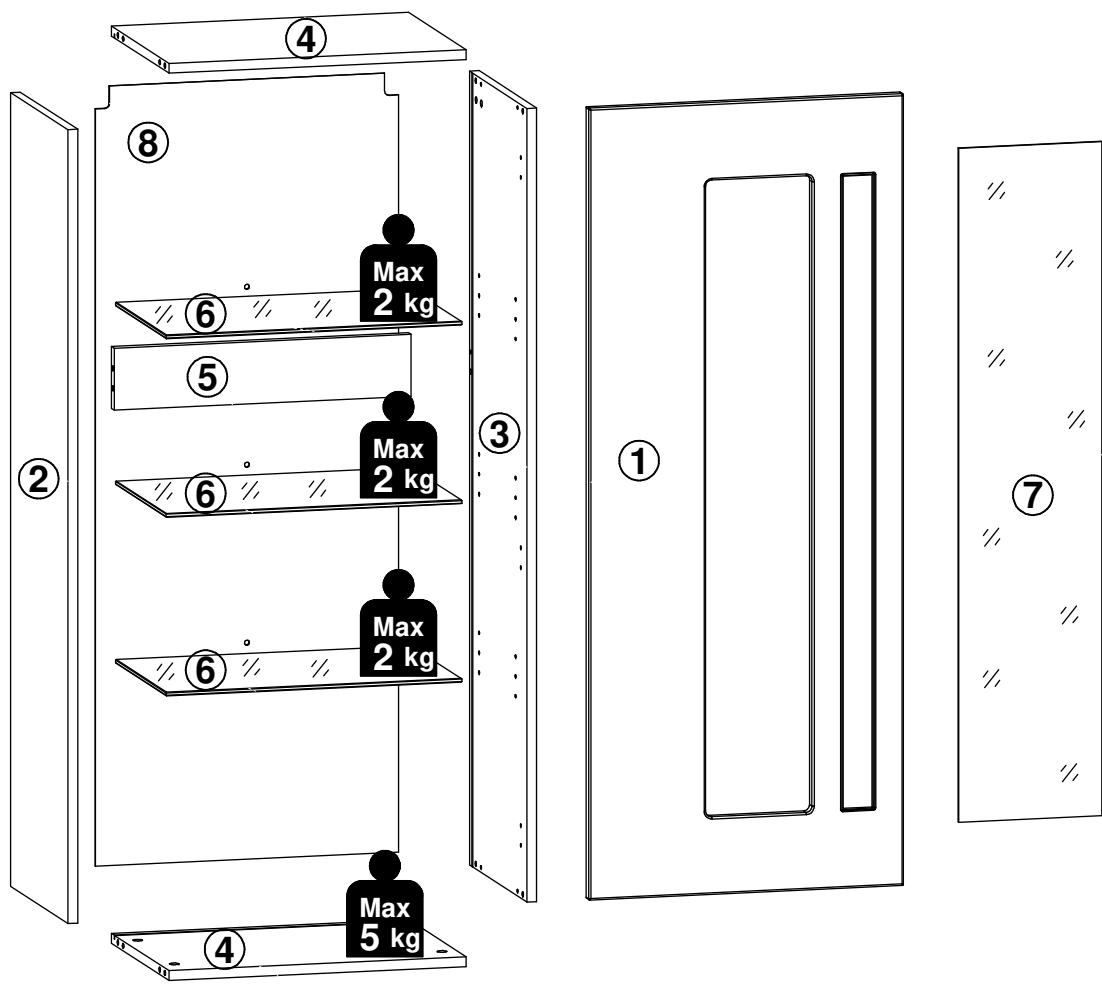
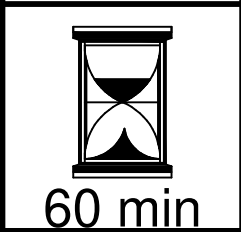
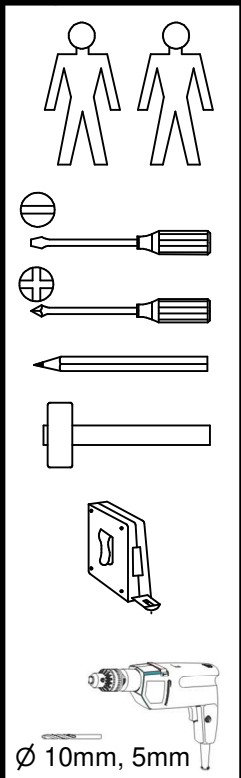

A	B	C (mm)			D
1	S616-0013	1277	517	18	1/1
2	S616-1013	1280	352	16	1/1
3	S616-1014	1280	352	16	1/1
4	S616-3016	488	352	16	1/1
5	S616-4004	488	100	16	1/1
6	S616-5007	486	310	6	1/1
7	S616-5008	1087	235	4	1/1
8	S616-9006	1257	498	2,5	1/1

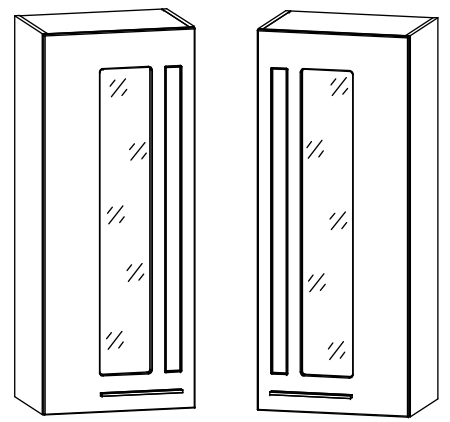
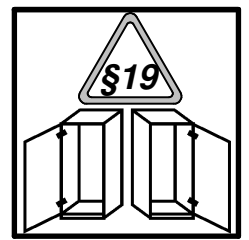

A

B





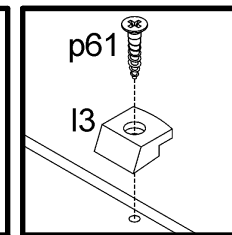
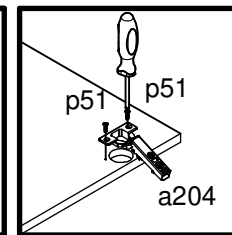
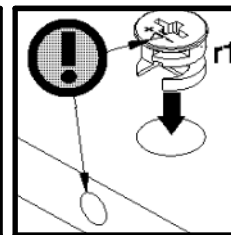
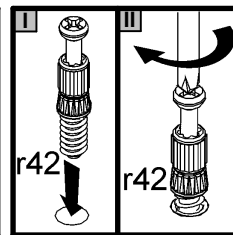
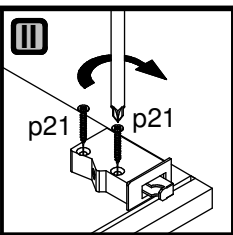
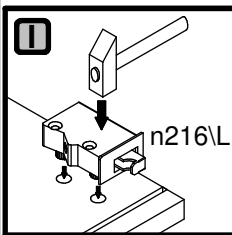
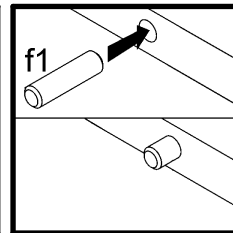
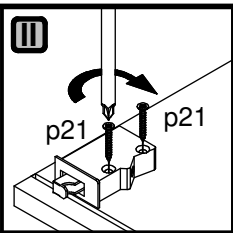
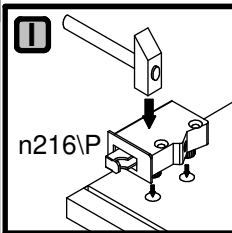
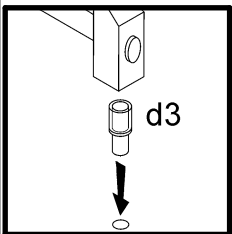
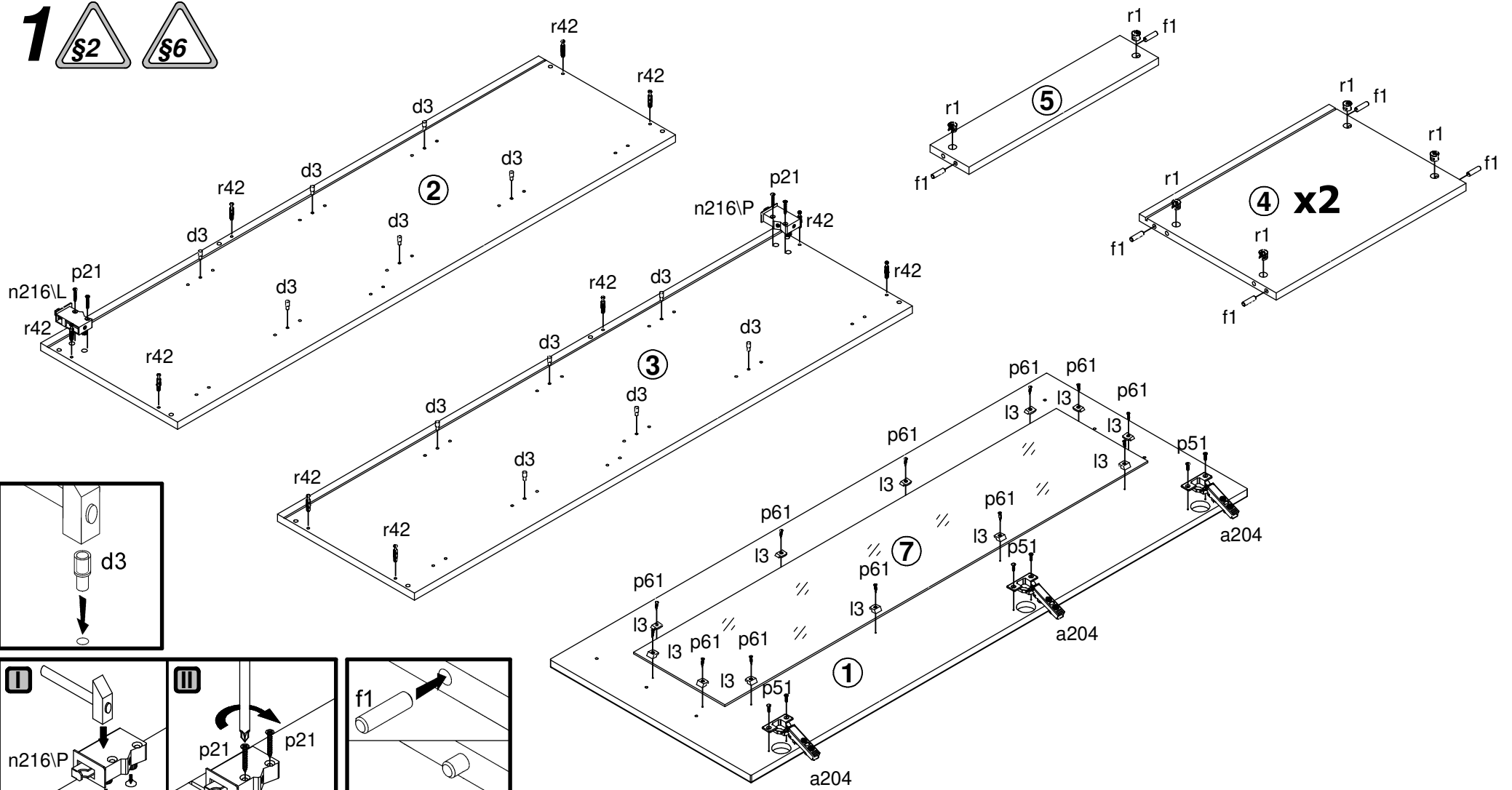

D
1/1

3x hamulec a204	3x b92	1x L-276mm c469\7	12x Ø5x17 mm d3	10x Ø8x30 mm f1	4x Ø10x50 mm f35	8x I2	12x I3	1x n216\L	1x n216\P	2x n217	1x 12V-6W o75\2	1x o80\3
3x o85\1	4x Ø25x60 mm p17	4x Ø4x30 mm p21	6x Ø3,5x15 mm p51	3x Ø4x25 mm p87	12x Ø3,5x16 mm p61	10x Ø15x12 mm #16 r1	10x 20\11 r42	8x Ø20mm s68				

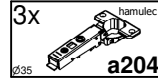
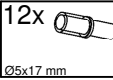
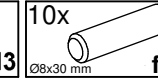
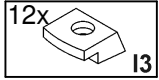
1  

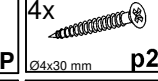
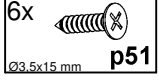
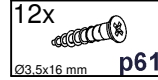

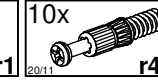
3x  a204	12x  d3	10x  f1	12x  l3
1x  n216L	1x  n216P	4x  p21	6x  p51
12x  p61	10x  r1	10x  r42	

2 

I

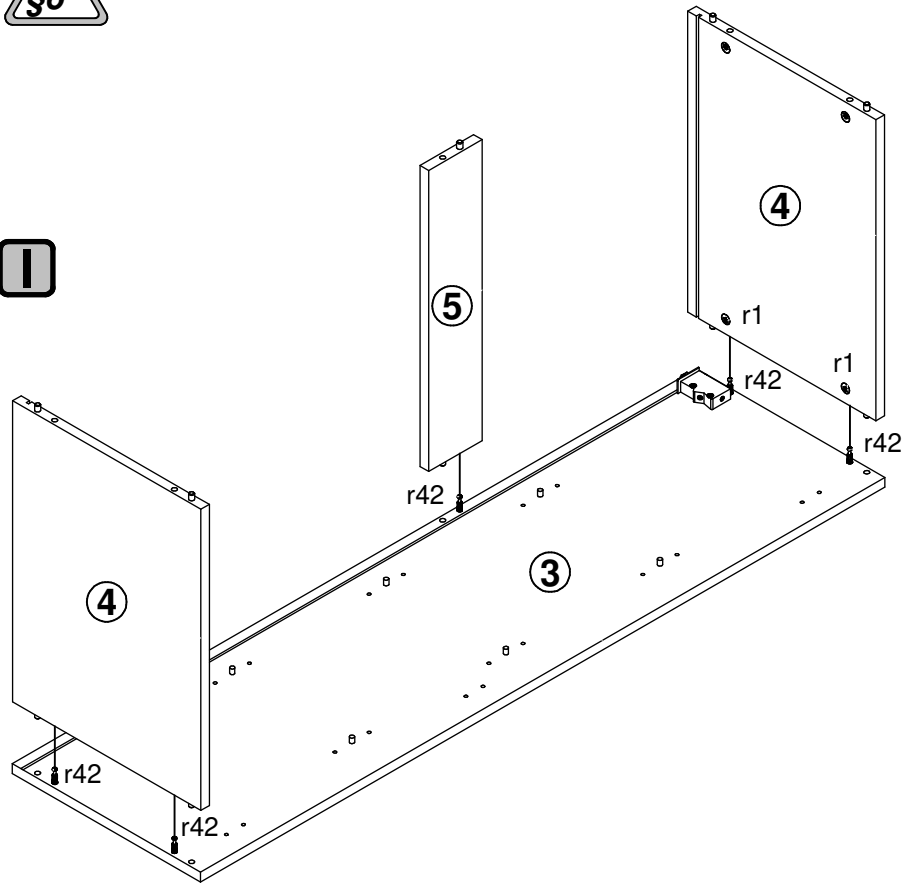

III

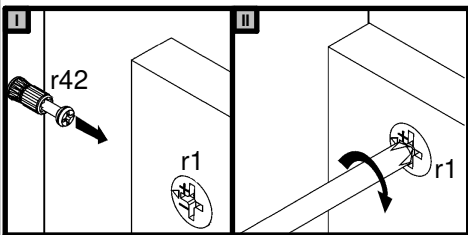
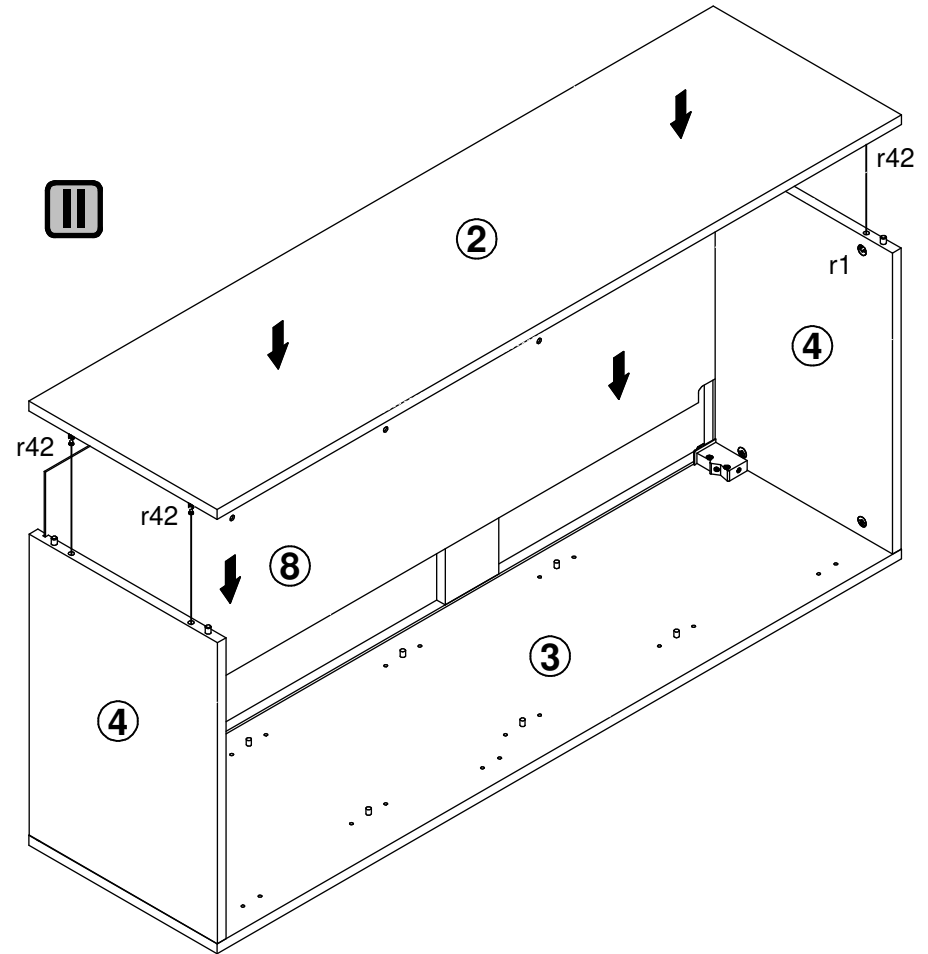

3 

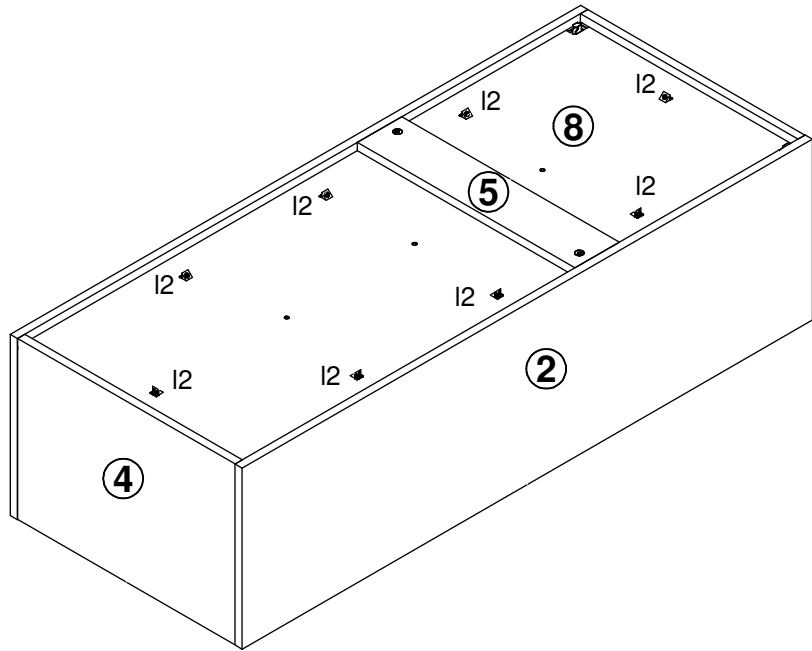
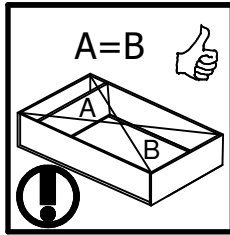

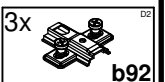
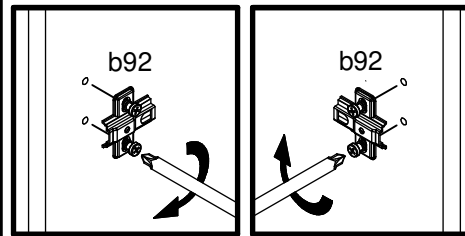
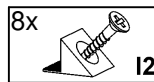
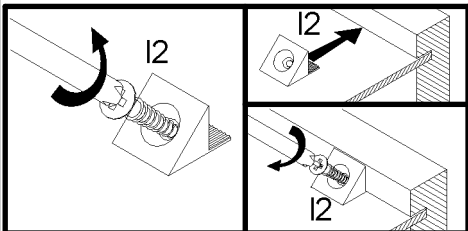
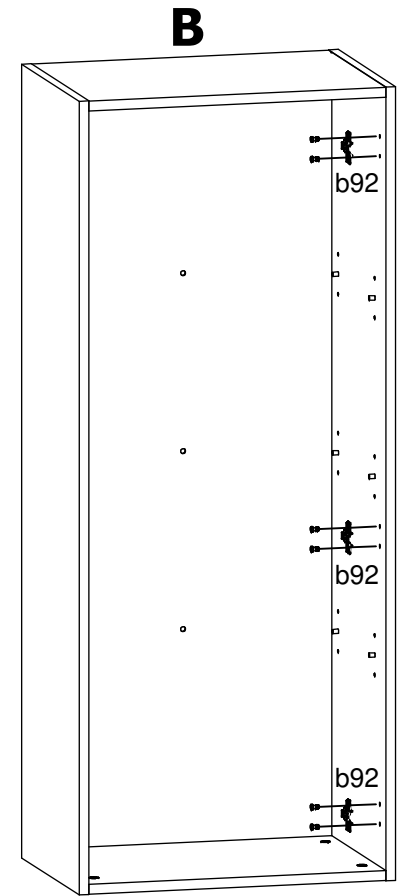
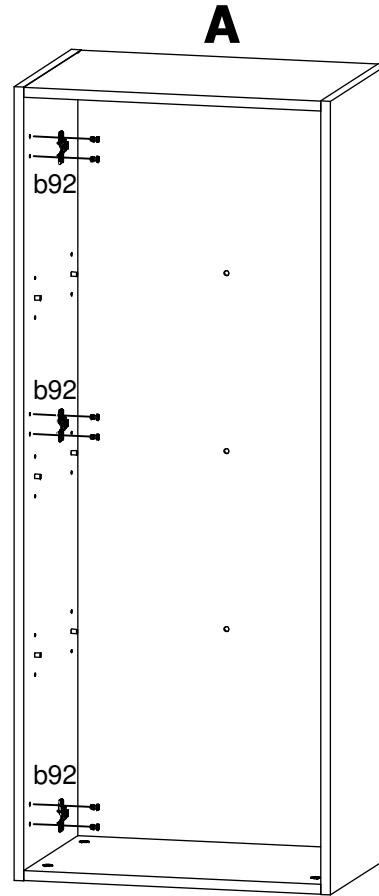
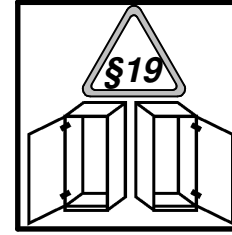

4 

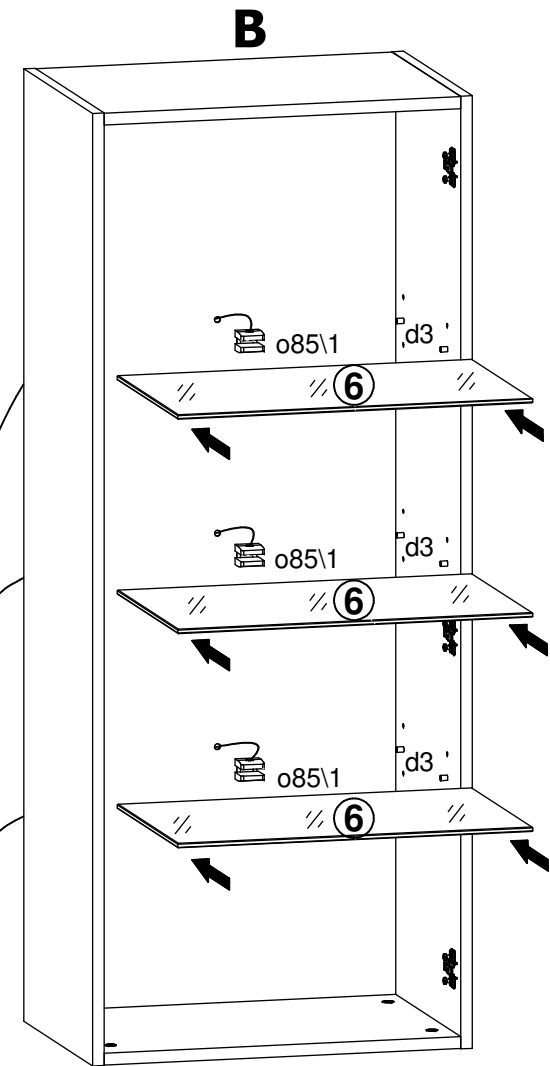
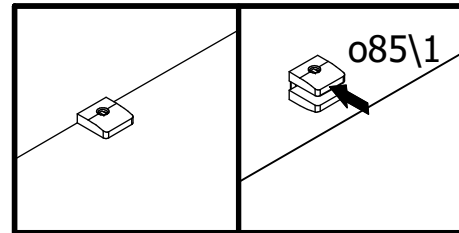
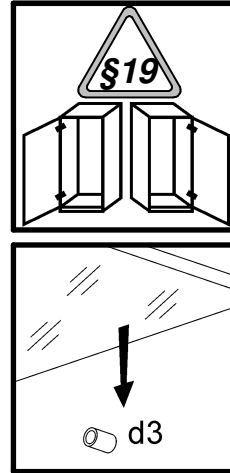
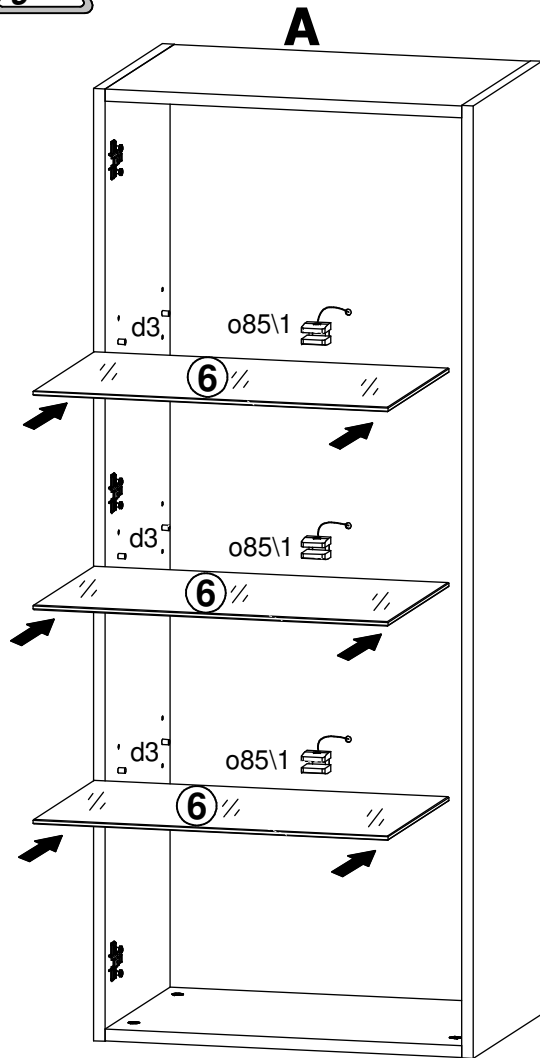

5 

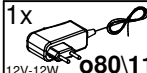

- 1x  12V-12W **o80\11**
- 1x  **o80\3**
- 3x  **o85\1**

6 §6

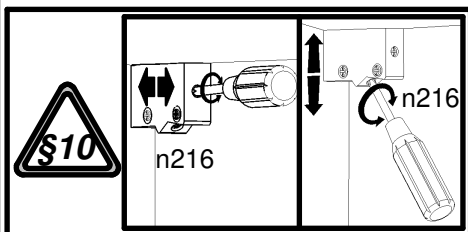
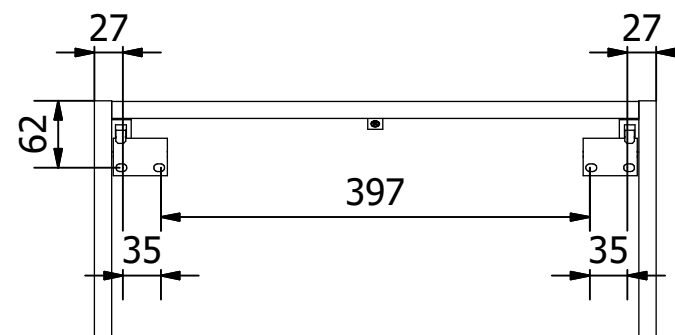
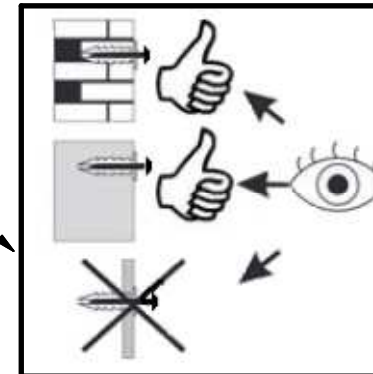
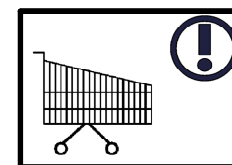
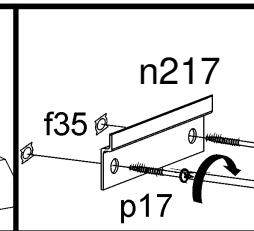
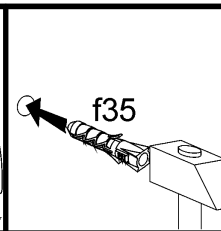
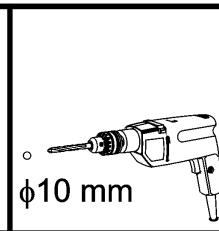
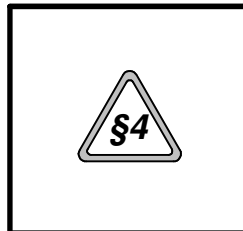
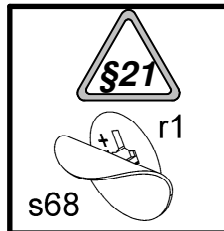
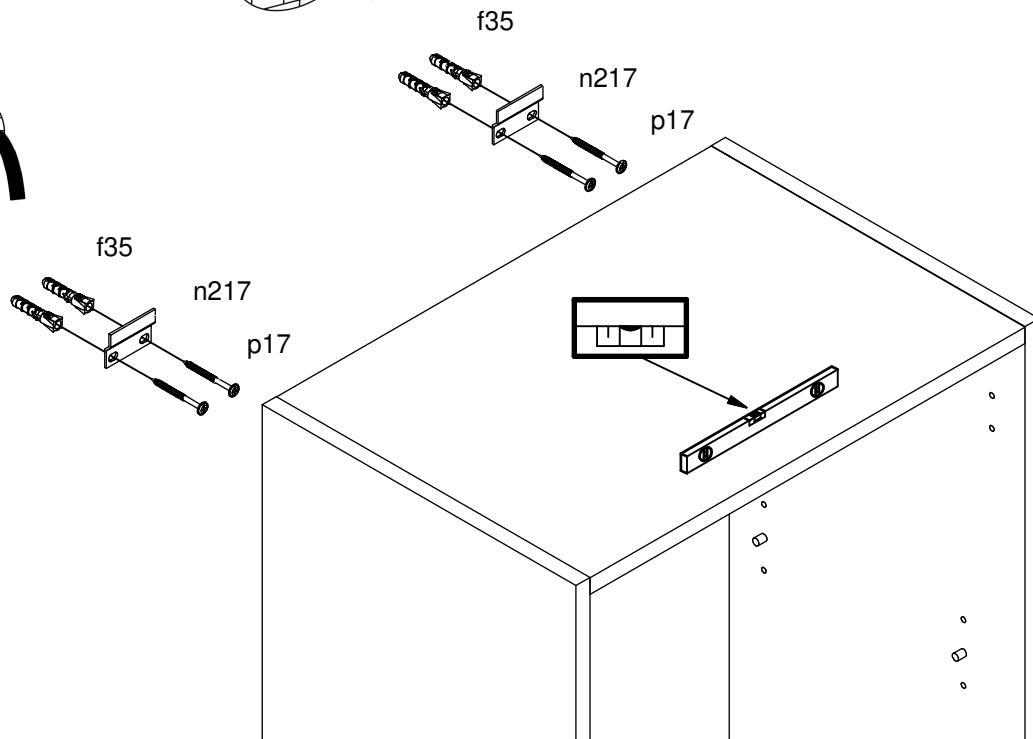

- 4x f35
- 2x n217
- 4x p17
- 8x s68

7 §6

A

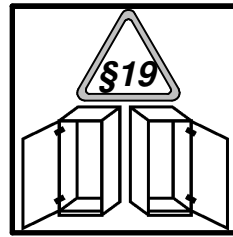

B

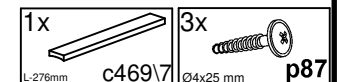
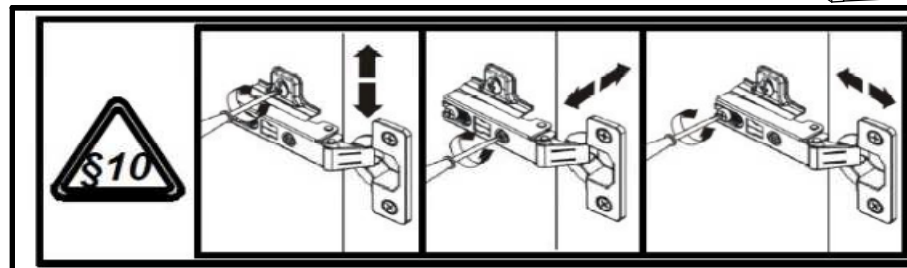
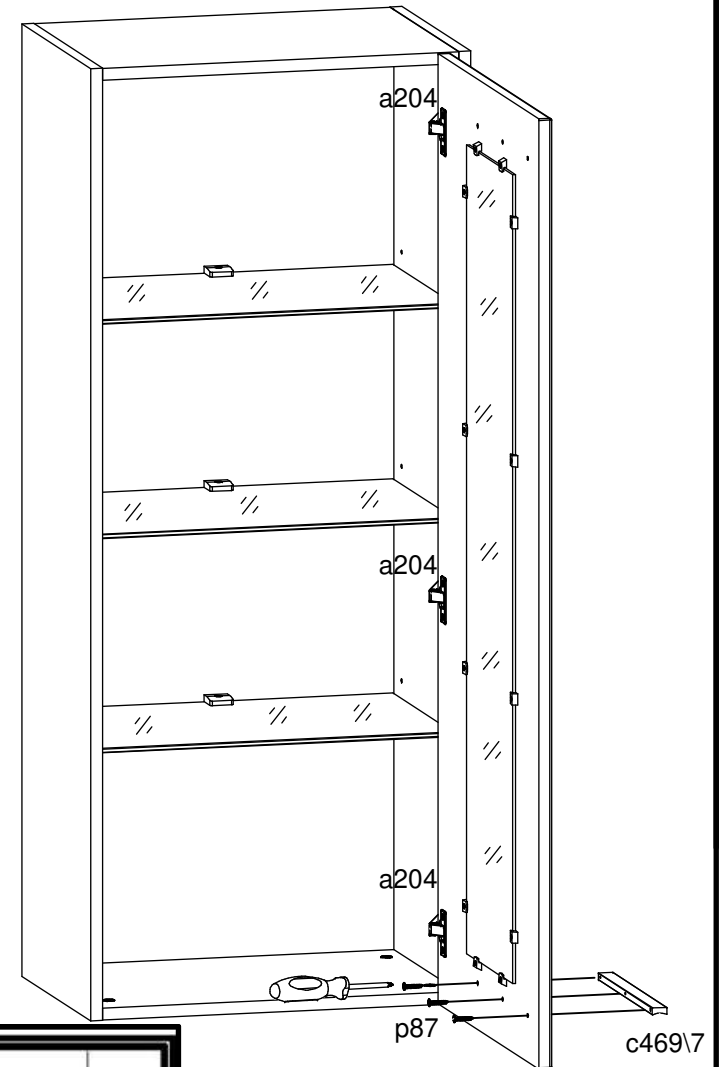
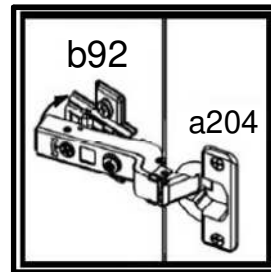
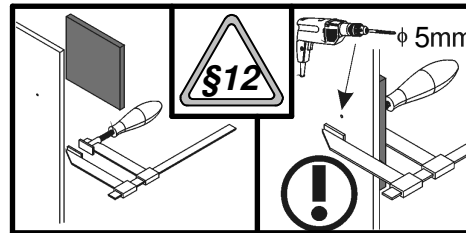
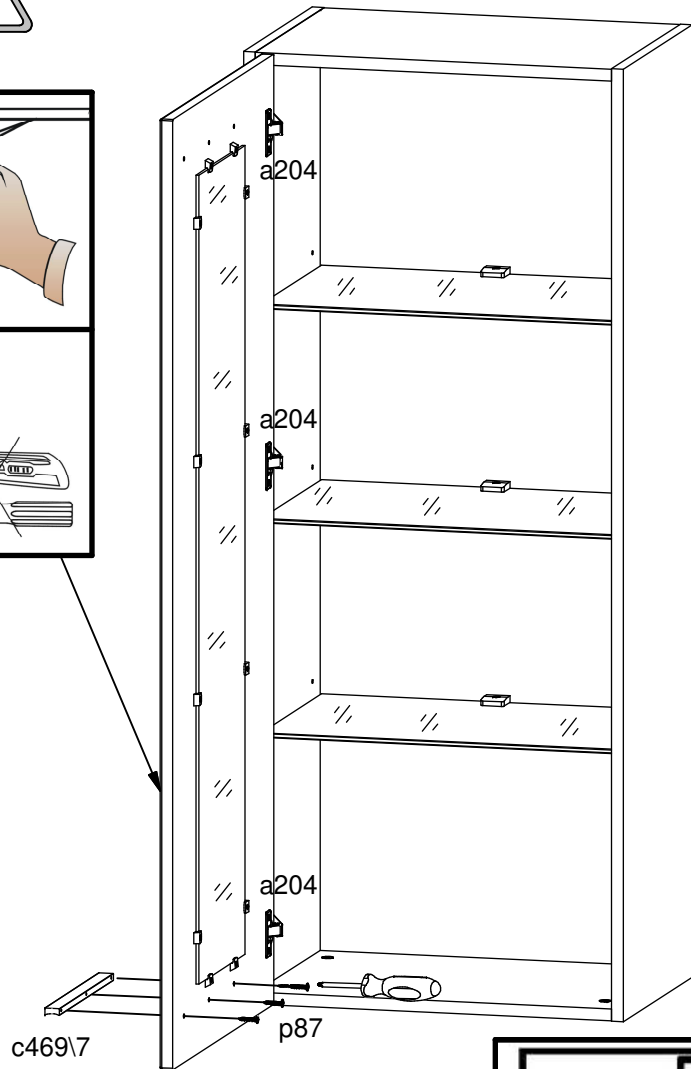
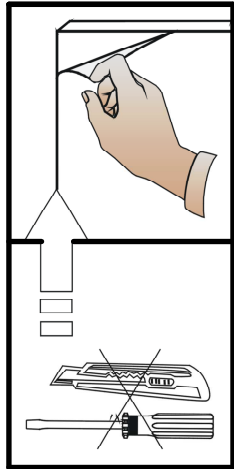

8

