

Modellname: **LIMA**
Nazwa modelu:

Modellreihe: **4014--03**
Numer modelu:

Type: **03**
Typ:

Blatt Nr: **1** von: **4**
Strona: **1** z: **4**

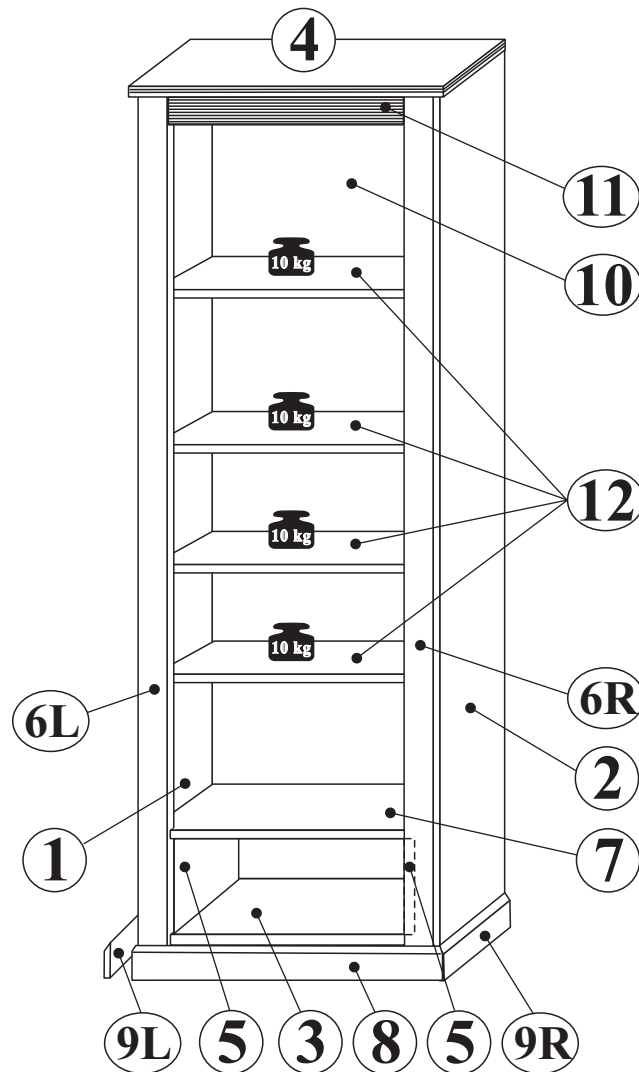
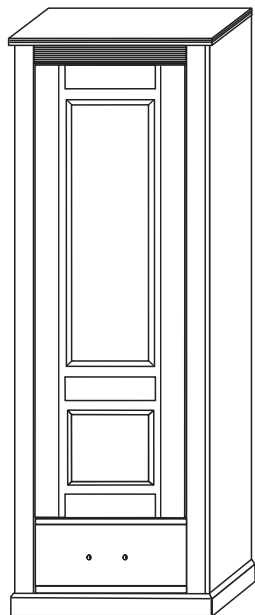

NR 1	
C5	$\phi 5$ x2
C12	x4
J11	x1
P13	3,5x13 x2
T13	8x50 mm x1
T14	6x45 mm x1

NR 2	
U30	x2
A2	M4x25 x4

OPTION LINKS

OPTION RECHTS

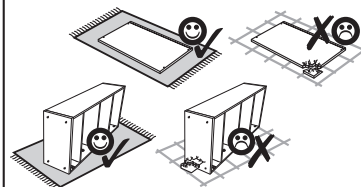
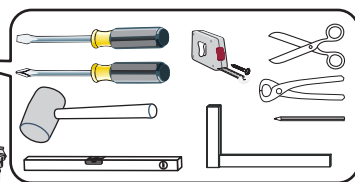
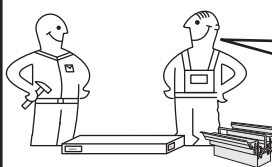
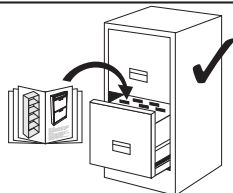
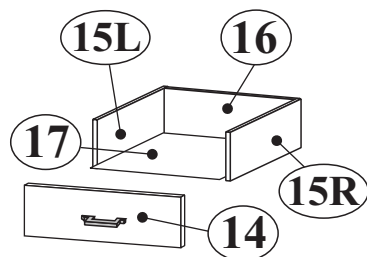
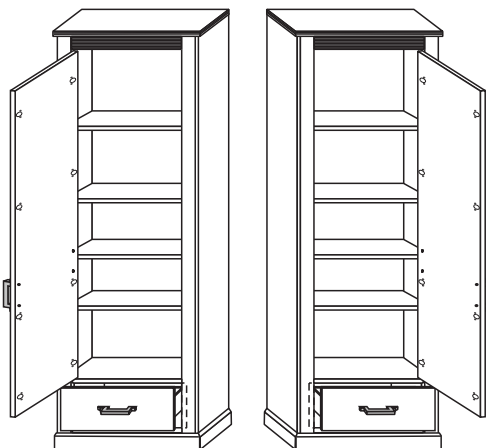

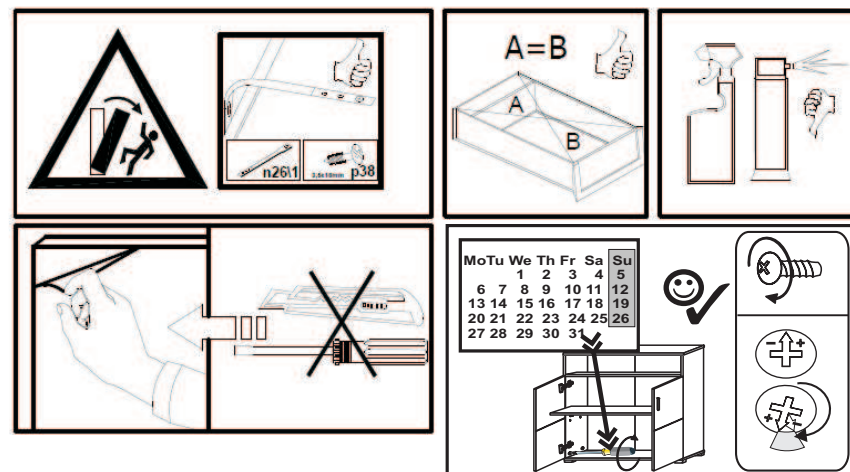
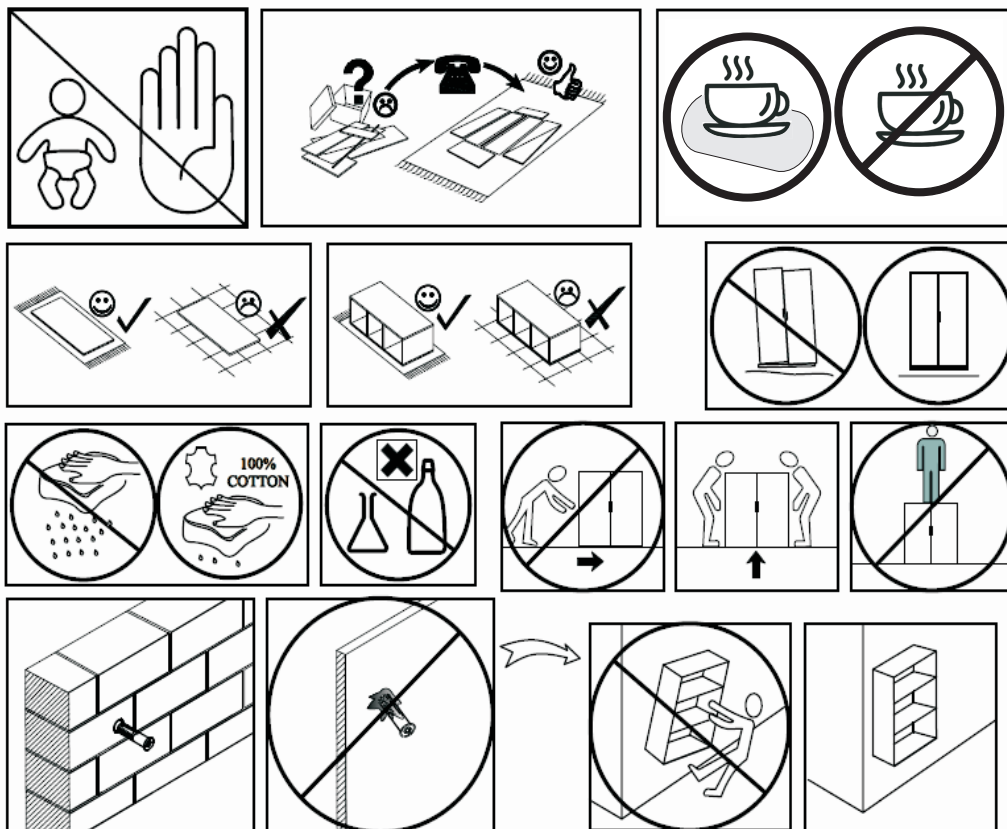
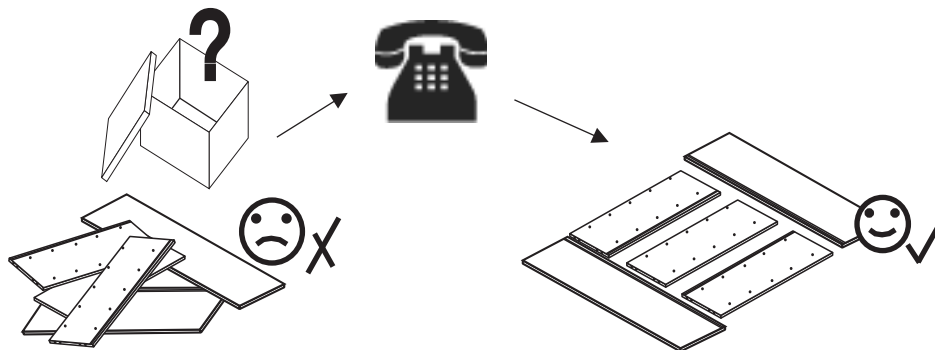

Modellname:
Nazwa modelu:

LIMA

Modellreihe:
Numer modelu:

4014--03

Type:
Typ:

03

Blatt Nr: 3 von: 4
Strona: z:

1

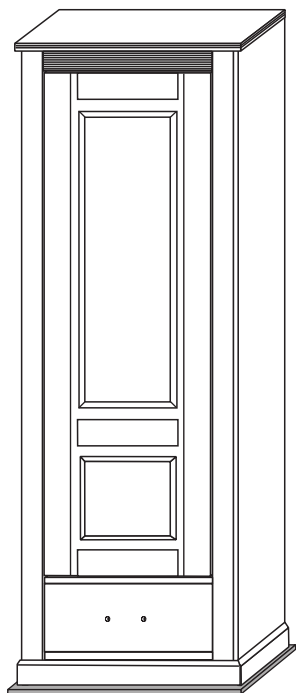

2

OPTION LINKS

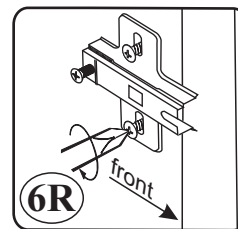
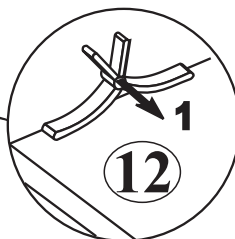
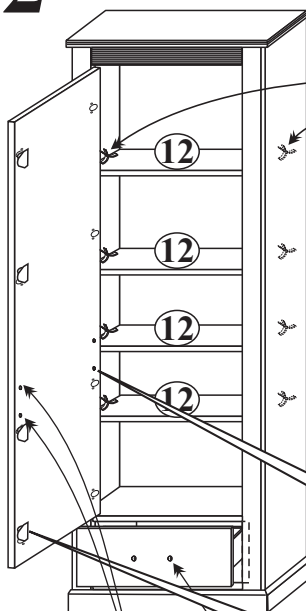

OPTION RECHTS

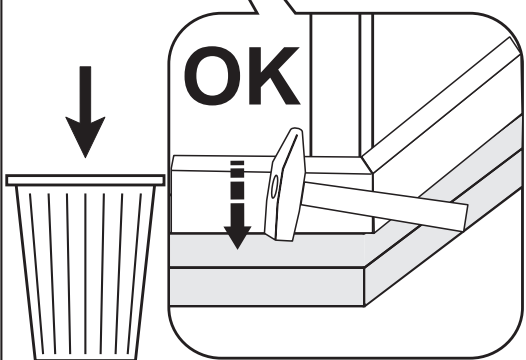
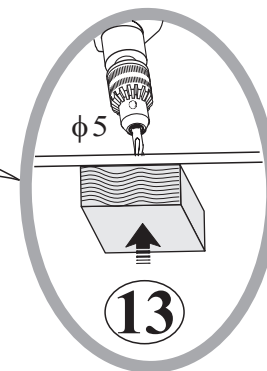
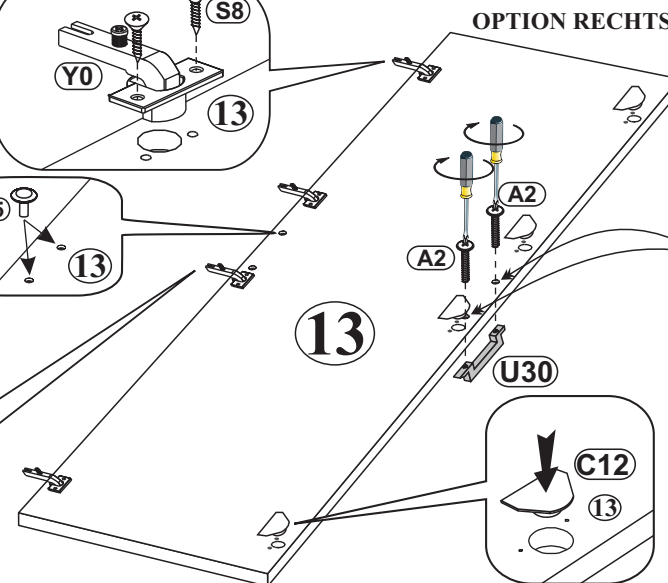
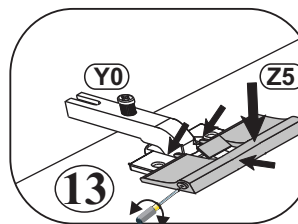
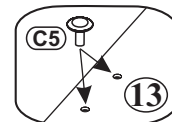
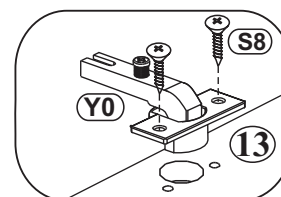
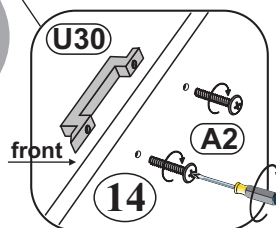
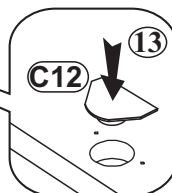
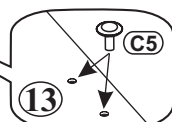
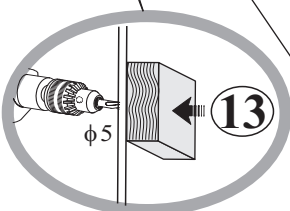
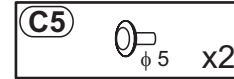
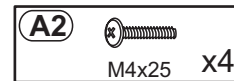
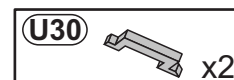
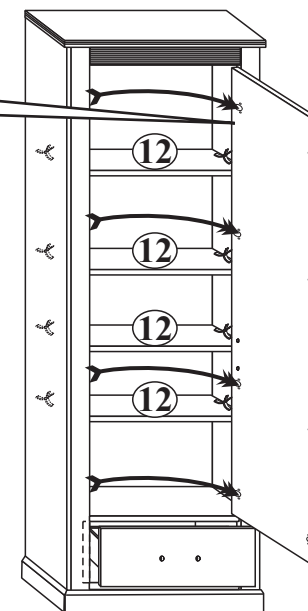

3

