

# JASMIN 5K 21--08

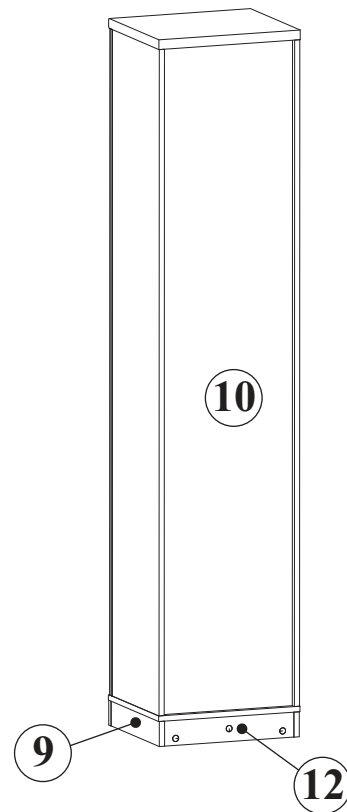

| NO | Dim. |     |    | Col.-No | Qty |
|----|------|-----|----|---------|-----|
| 1  | 1918 | 353 | 16 | 2       | 1   |
| 2  | 1918 | 353 | 16 | 2       | 1   |
| 4  | 432  | 380 | 16 | 1       | 1   |
| 3  | 432  | 380 | 28 | 1       | 1   |
| 5  | 398  | 333 | 22 | 1       | 1   |
| 6  | 398  | 333 | 22 | 1       | 3   |
| 11 | 1918 | 43  | 19 | 2       | 2   |
| 7  | 430  | 72  | 16 | 1       | 1   |
| 12 | 396  | 72  | 16 | 1       | 1   |
| 8  | 363  | 72  | 16 | 1       | 1   |
| 9  | 363  | 72  | 16 | 1       | 1   |
| 10 | 1930 | 410 | 3  | 2       | 1   |

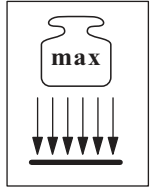

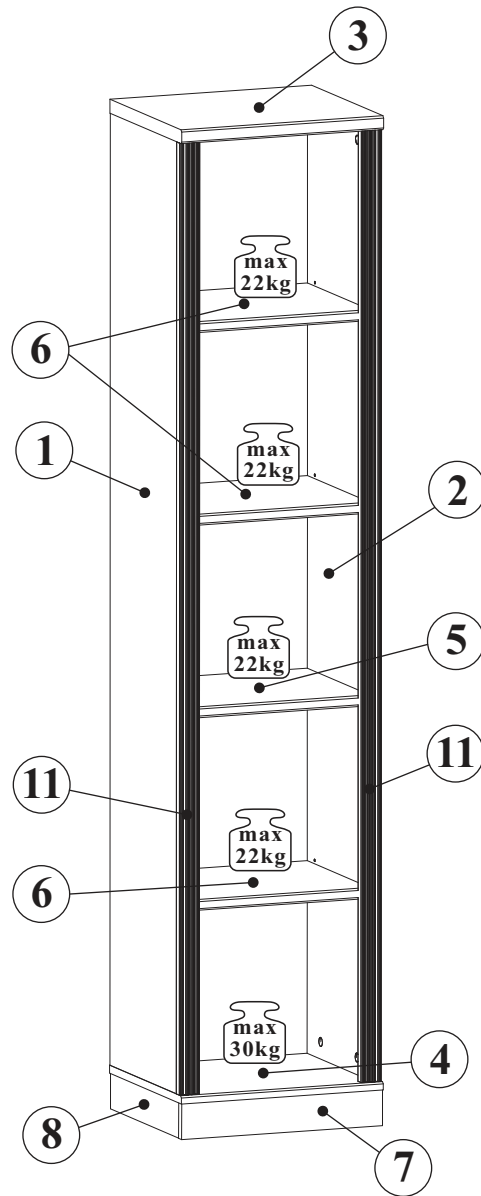
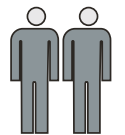

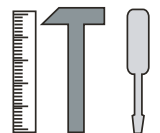

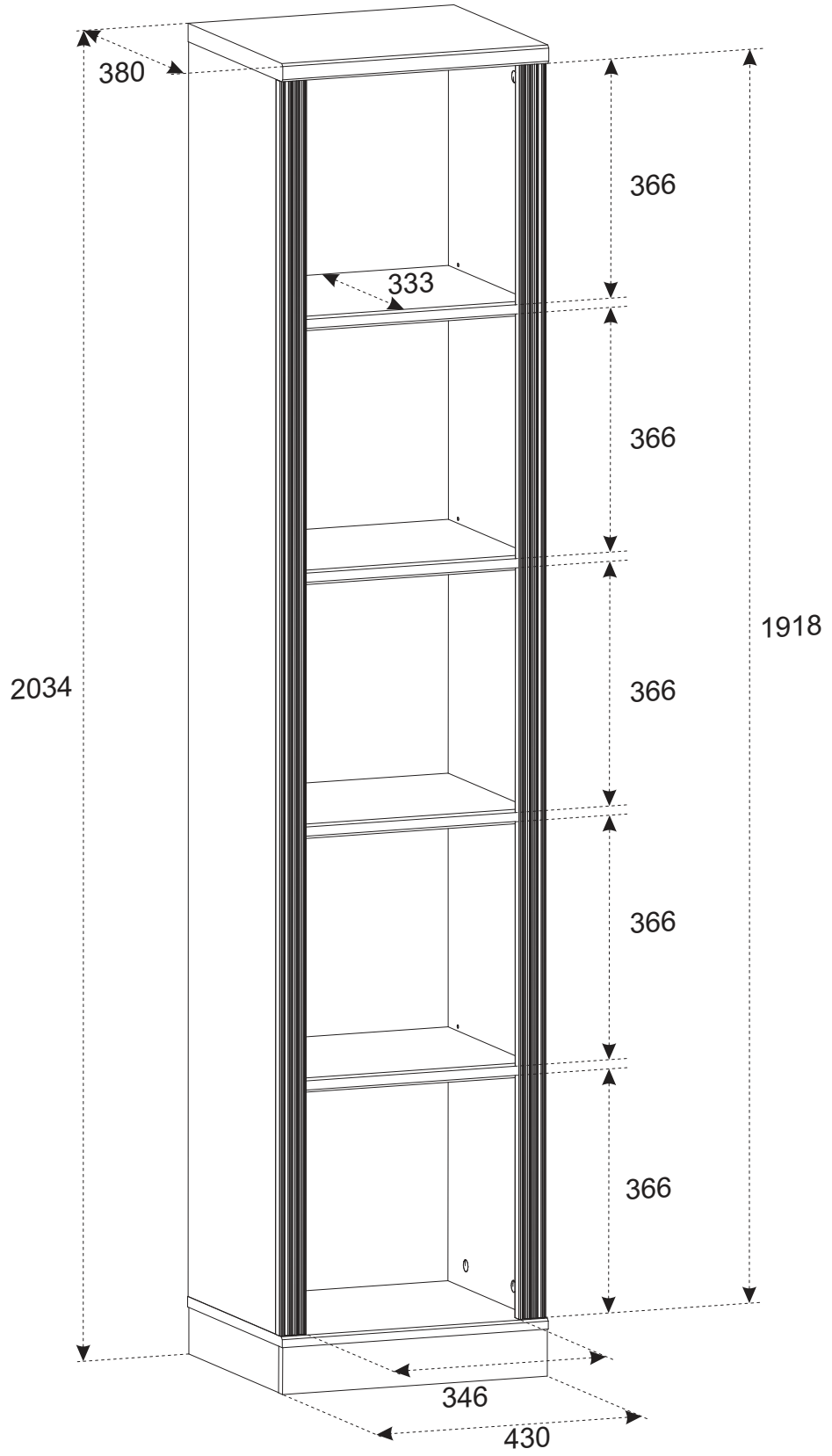

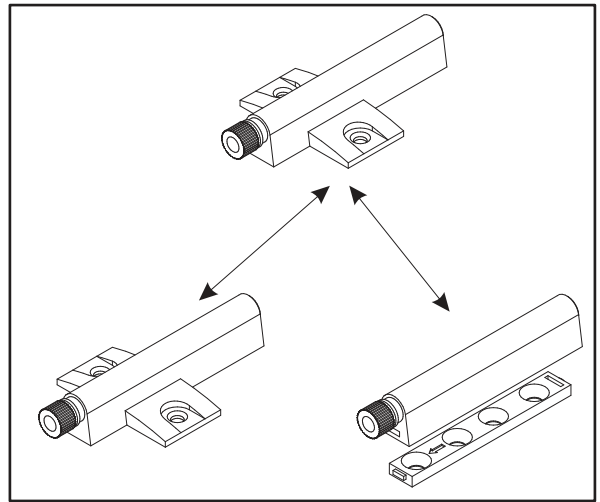
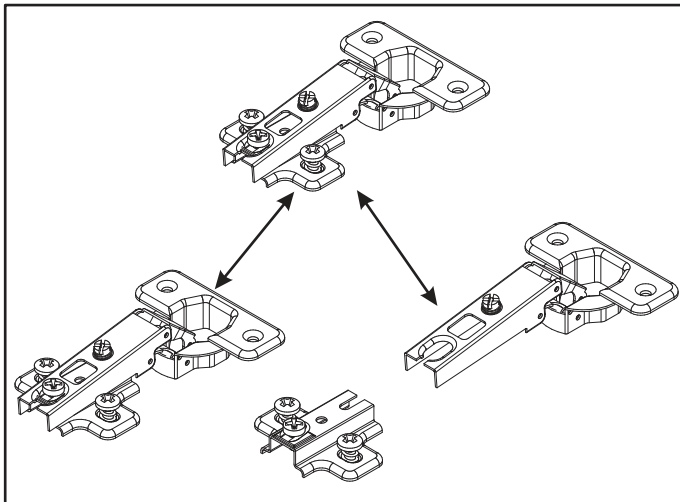
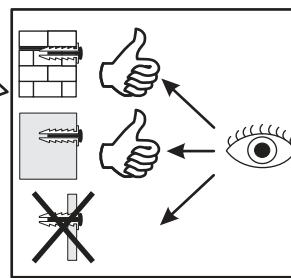
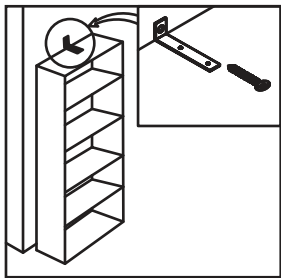
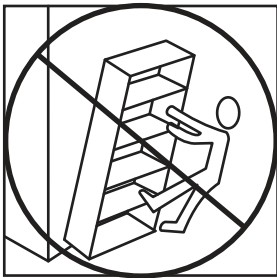
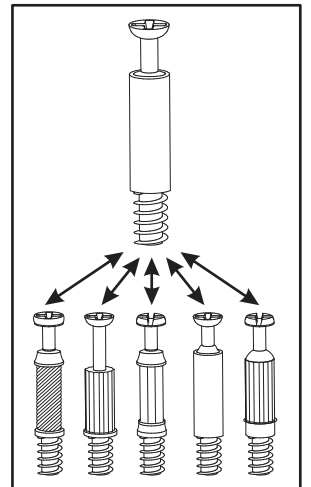
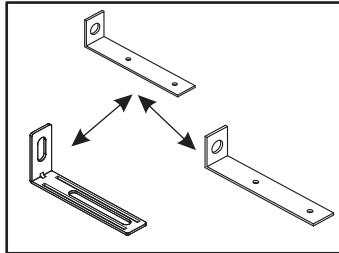
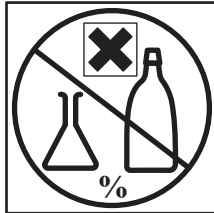
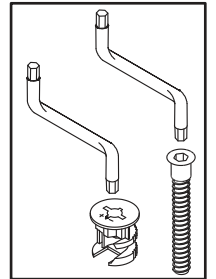
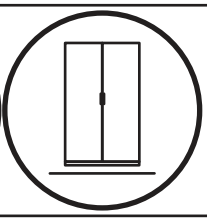
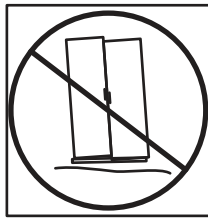
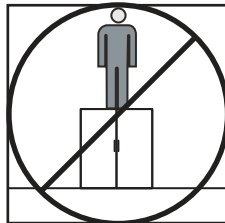
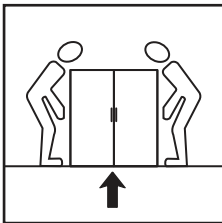
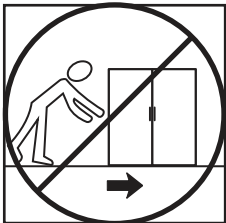
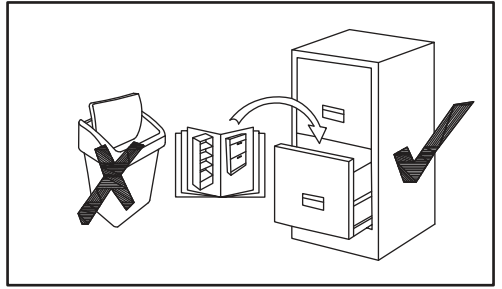
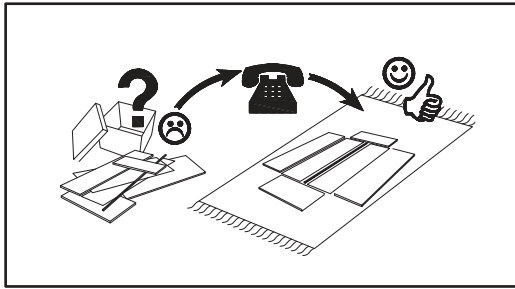
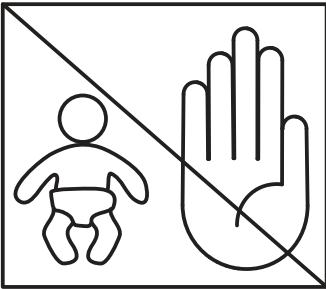
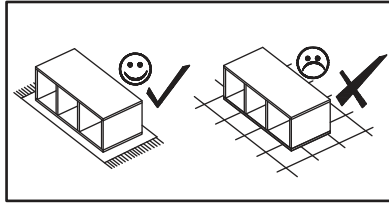
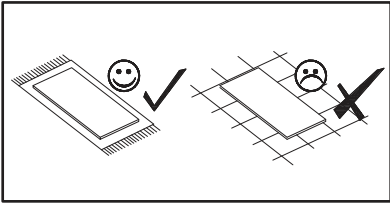

180 min

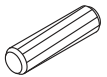
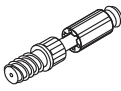



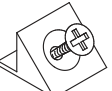

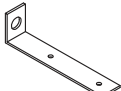
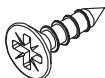
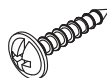
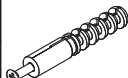
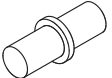
JASMIN 5K 21 -- 08

|                    |   |           |   |                        |   |                       |  |           |   |           |   |
|--------------------|---|-----------|---|------------------------|---|-----------------------|--|-----------|---|-----------|---|
| A1<br>x36<br>ø8x36 |  | B4<br>x30 |  | B5<br>x26<br>ø15x12    |  | B16<br>x4<br>ø15x16   |  | G5<br>x30 |  | S1<br>x14 |  |
| I2<br>x4           |  | L1<br>x1  |  | D10<br>x2<br>USØ3,5x13 |  | UP13<br>x2<br>UPØ3x16 |  | KR1<br>x1 |  | G7<br>x12 |  |
| G2<br>x1           |  |           |   |                        |   |                       |  |           |   |           |   |

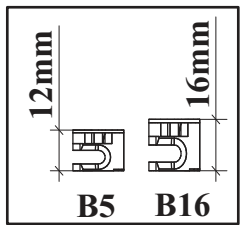
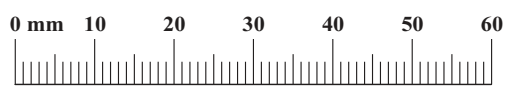

1

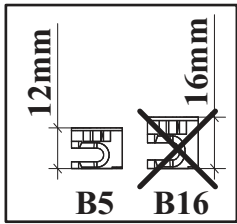

|     |       |
|-----|-------|
| A1  |       |
| x10 | ø8x36 |

|    |  |
|----|--|
| G7 |  |
| x6 |  |

|    |        |
|----|--------|
| B5 |        |
| x9 | ø15x12 |

|    |  |
|----|--|
| B4 |  |
| x2 |  |

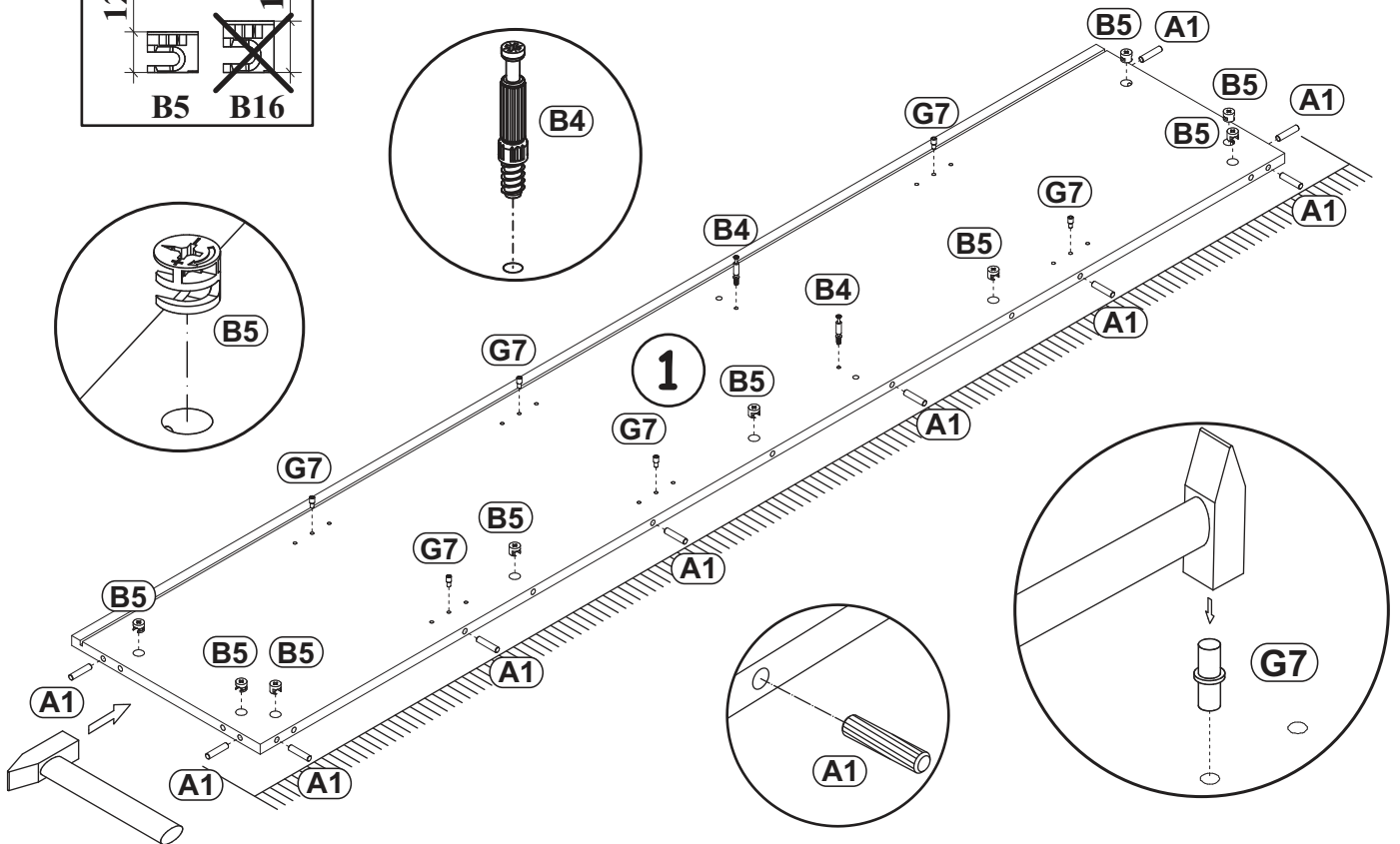

2

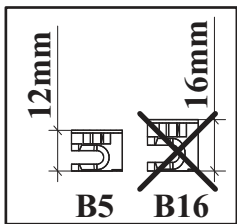

|     |       |
|-----|-------|
| A1  |       |
| x10 | ø8x36 |

|    |  |
|----|--|
| G7 |  |
| x6 |  |

|    |        |
|----|--------|
| B5 |        |
| x9 | ø15x12 |

|    |  |
|----|--|
| B4 |  |
| x2 |  |

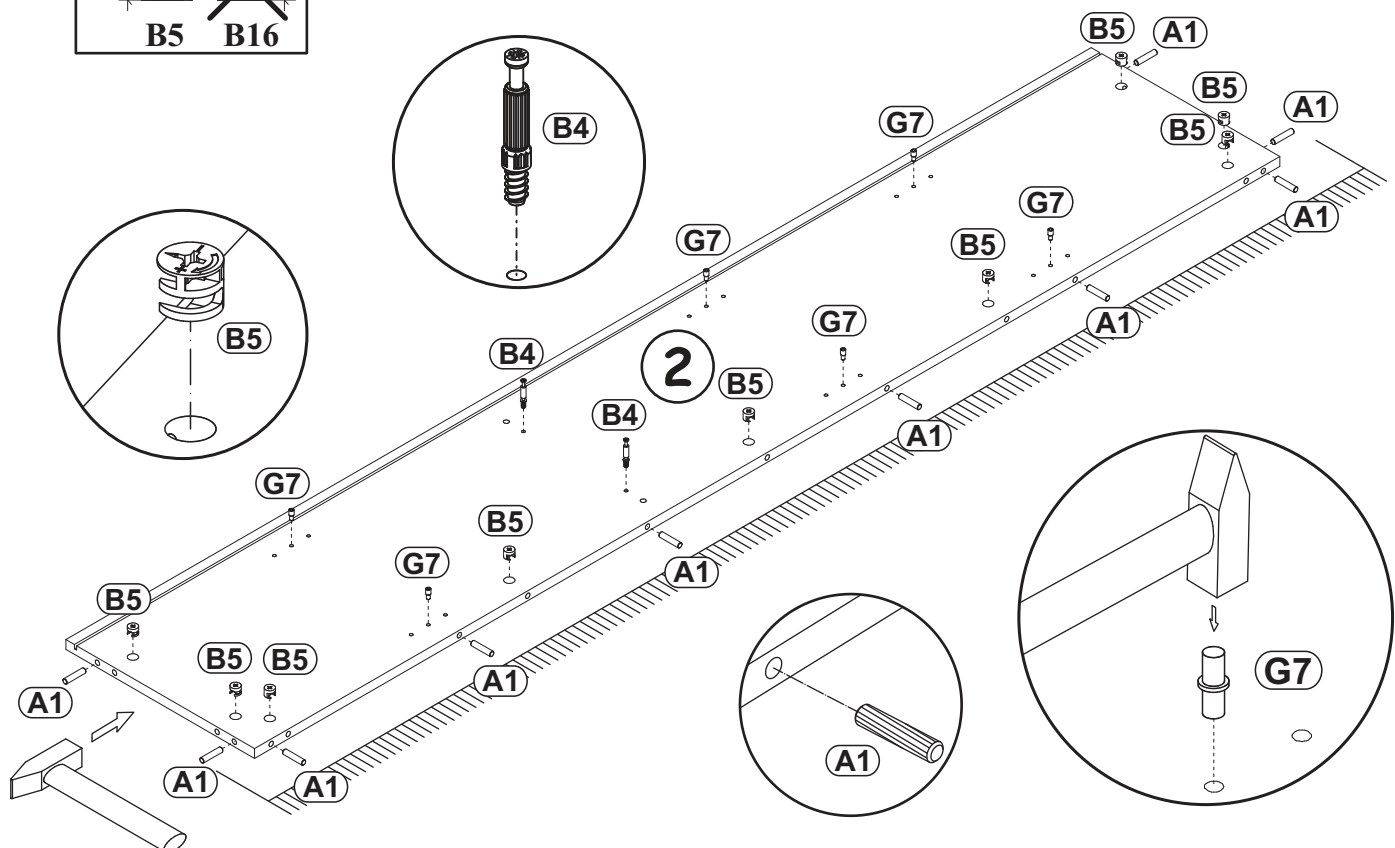

3

|    |  |
|----|--|
| A1 |  |
| x4 | ø8x36  |

|     |   |
|-----|---|
| B16 |  |
| x4  | Ø15x16  |

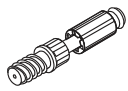
|    |   |
|----|---|
| B4 |  |
| x4 |   |

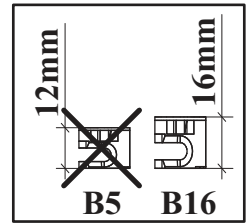
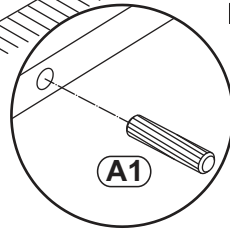
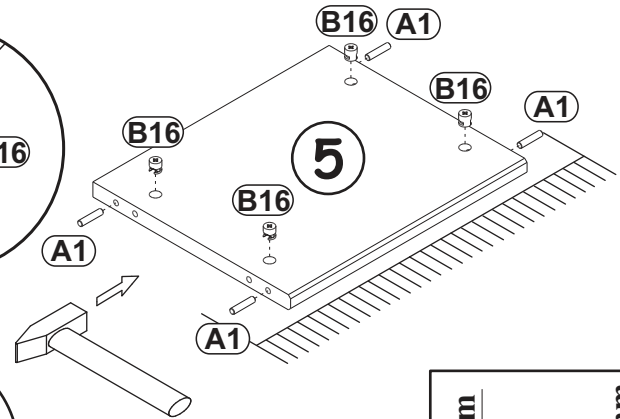
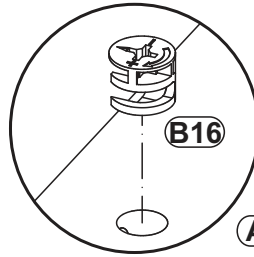
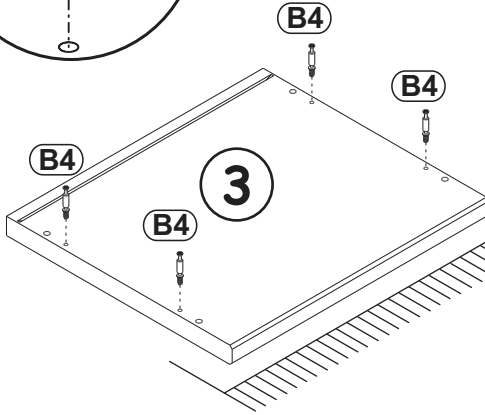
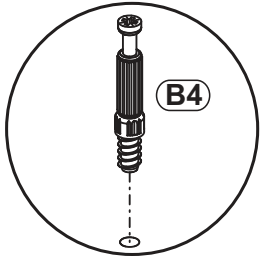

4

|     |   |
|-----|---|
| A1  |  |
| x12 | ø8x36   |

|    |  |
|----|--|
| B5 |  |
| x8 | ø15x12   |

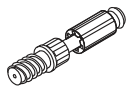
|    |  |
|----|--|
| B4 |  |
| x8 |  |

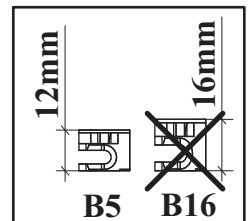
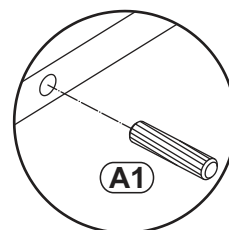
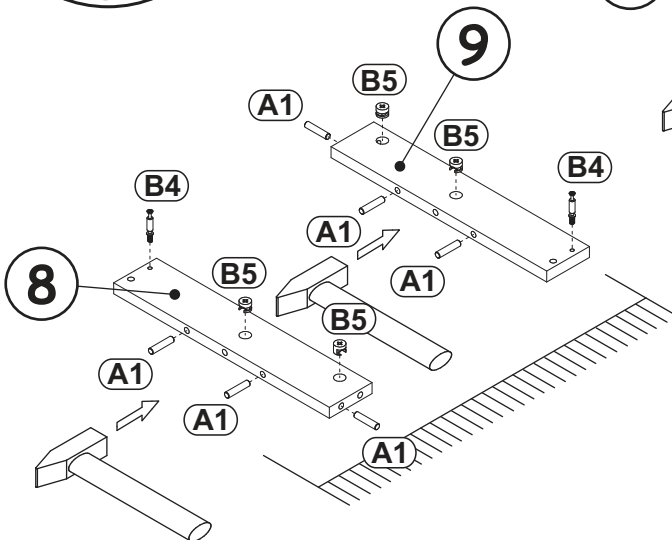
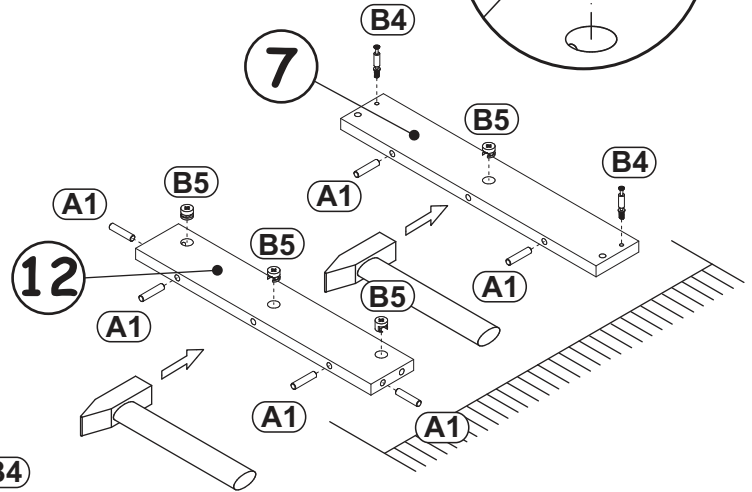
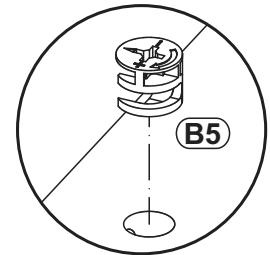
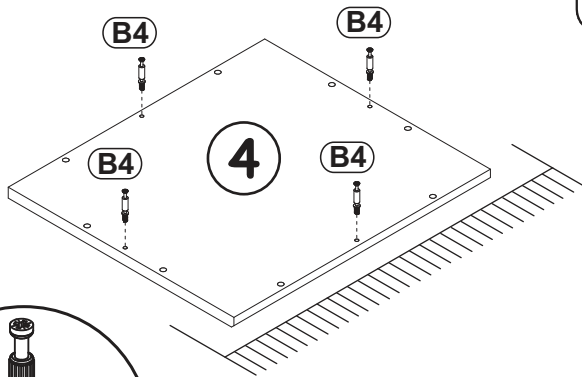
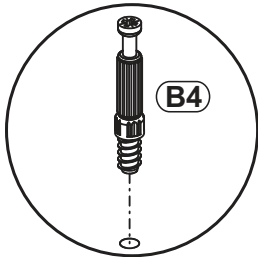

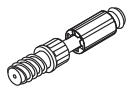
|     |   |
|-----|---|
| B4  |  |
| x10 |   |

5

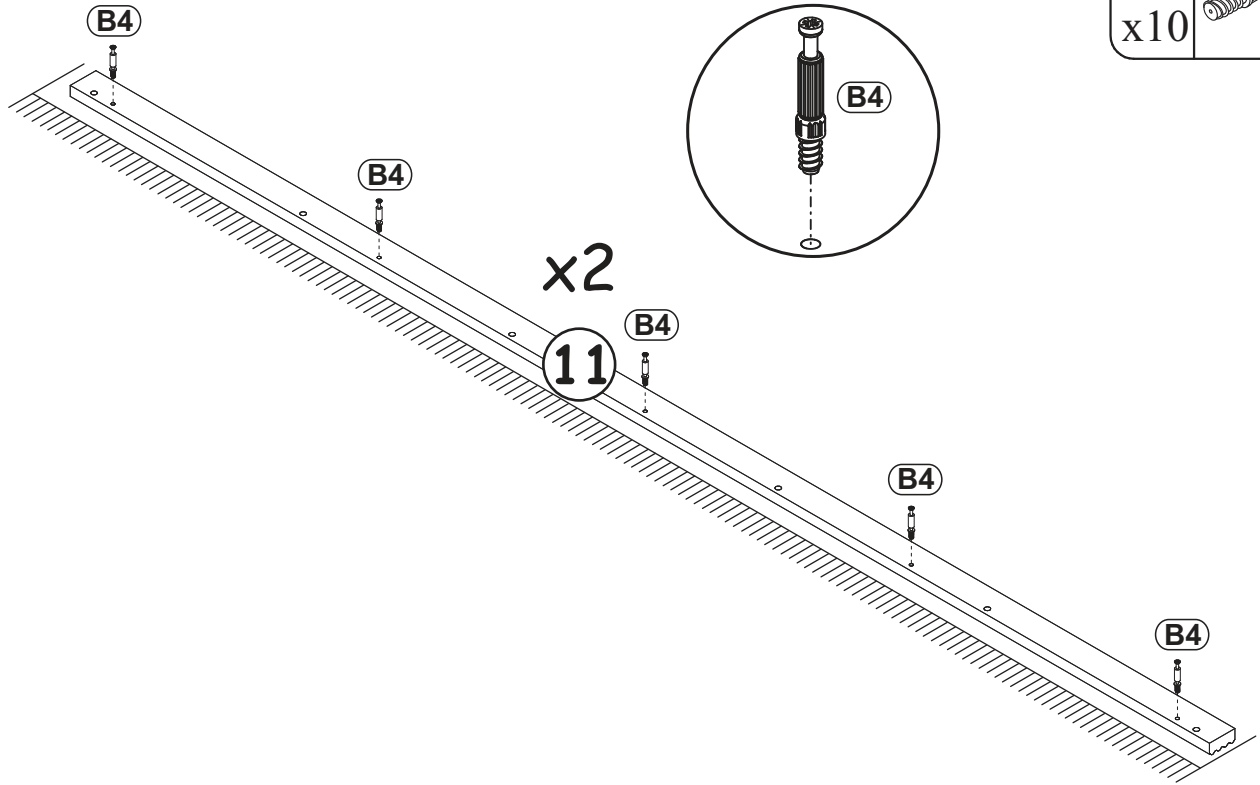

6

|    |   |
|----|---|
| G5 |  |
| x5 |   |

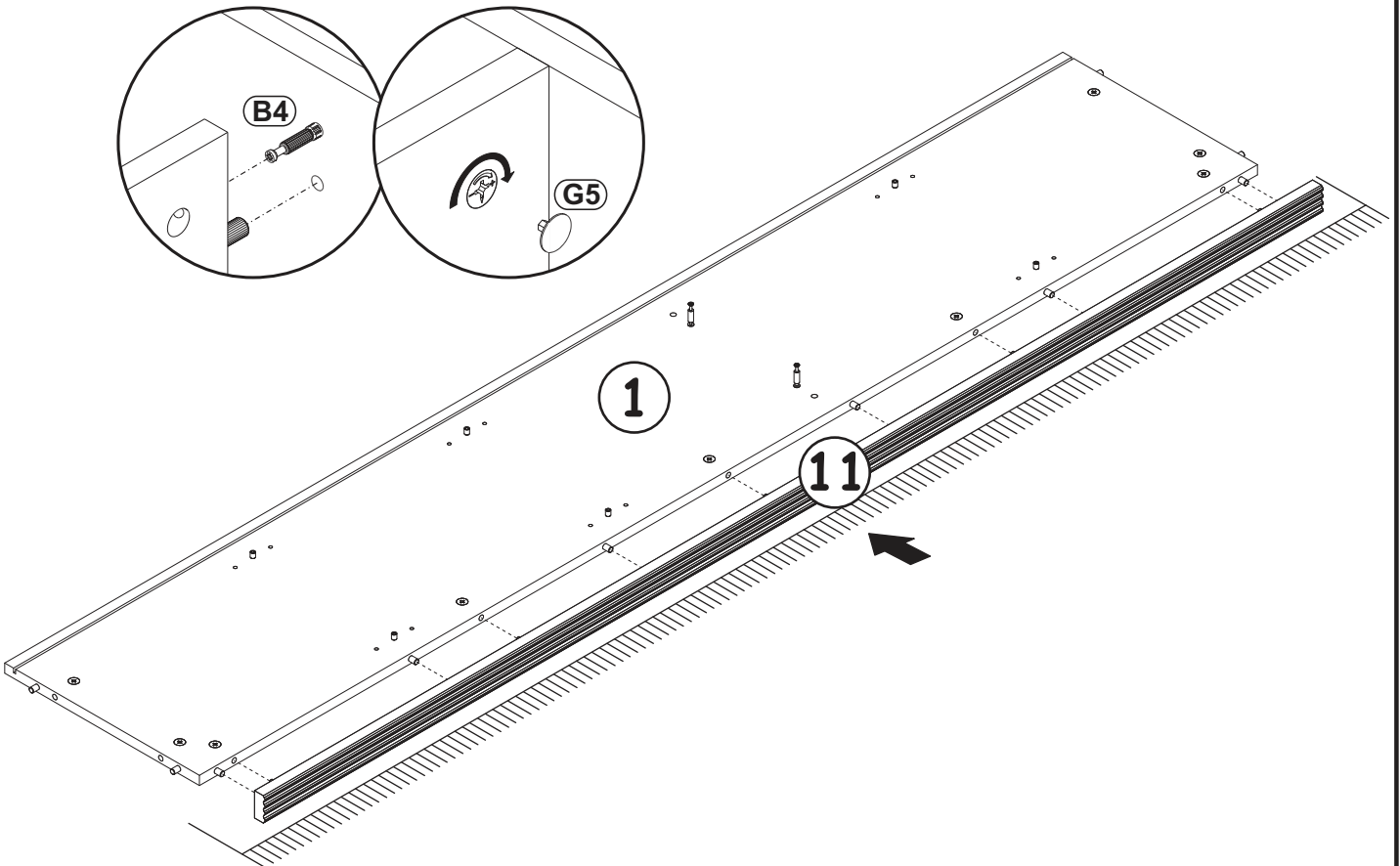

|    |   |
|----|---|
| G5 |  |
| x5 |   |

7

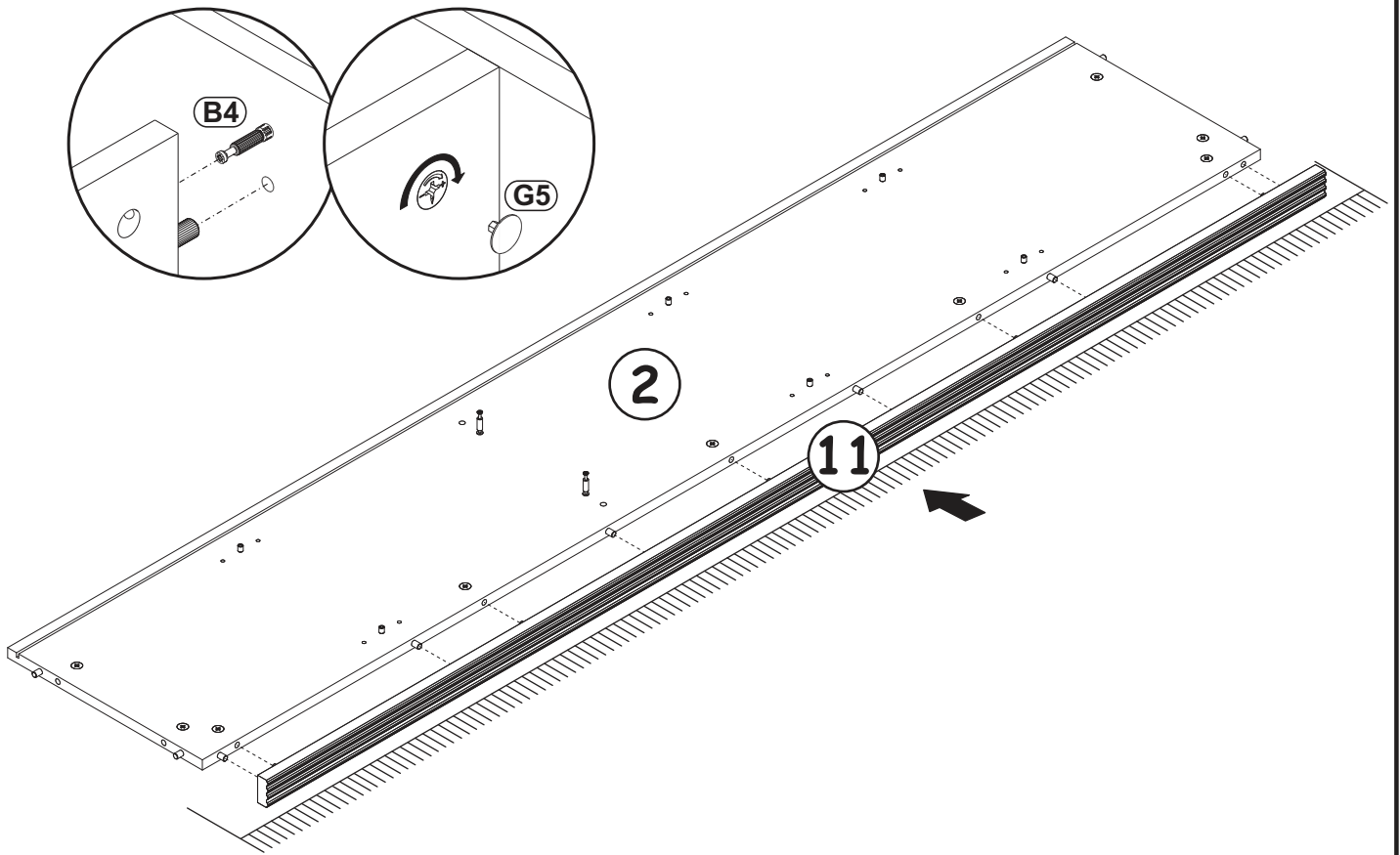

8

|    |   |
|----|---|
| G5 |  |
| x2 |   |

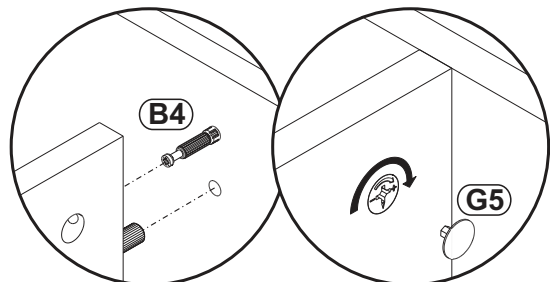
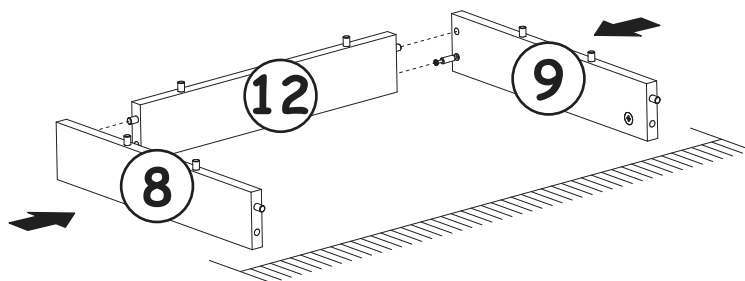



9

|    |   |
|----|---|
| G5 |  |
| x2 |   |

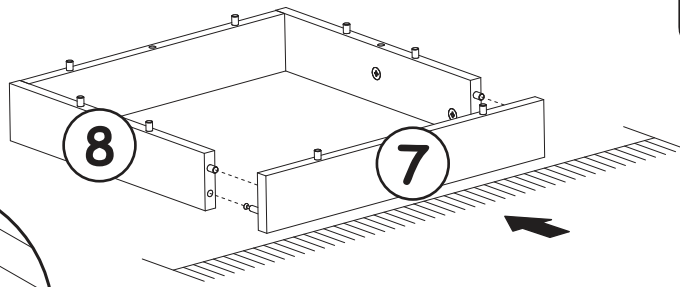
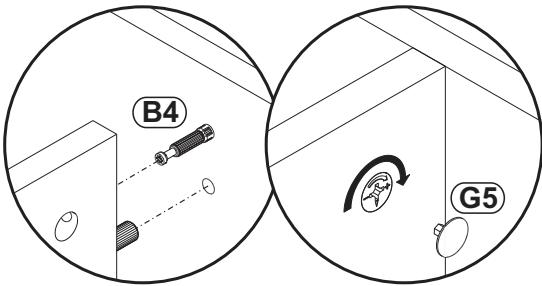

180°

10

|    |   |    |   |
|----|---|----|---|
| I2 |  | G5 |  |
| x4 |   | x4 |   |

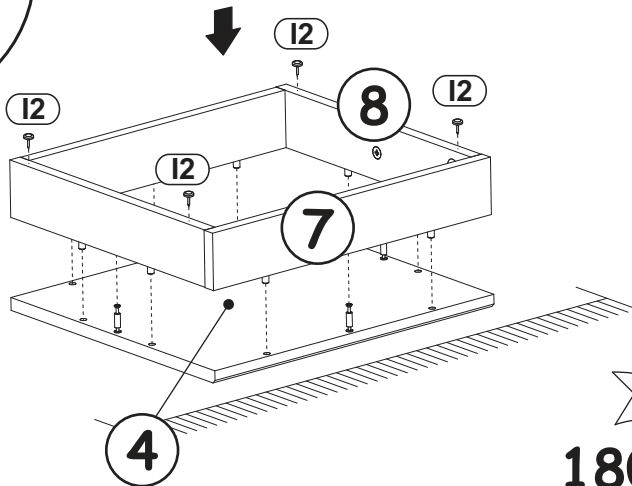
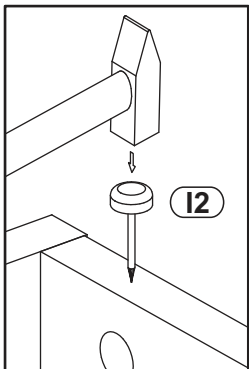
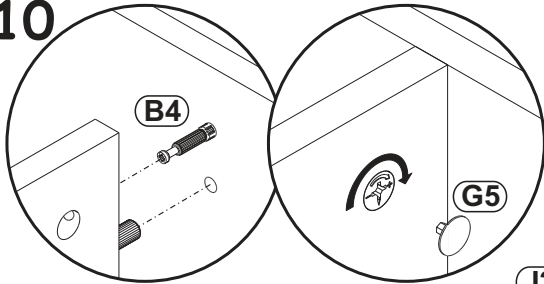

180°

11

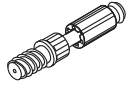
|    |   |
|----|---|
| B4 |  |
| x4 |   |

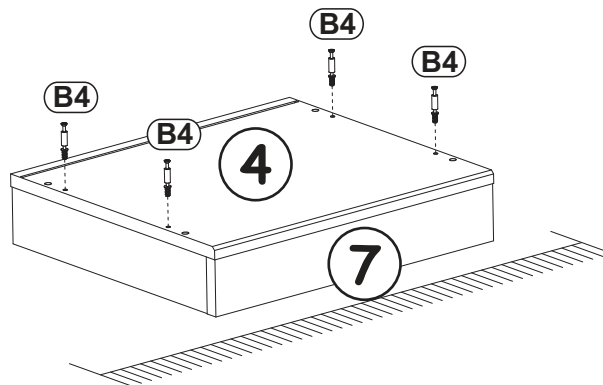
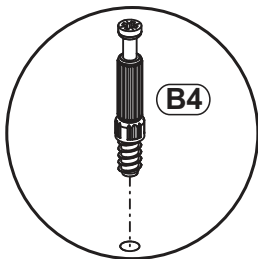

12

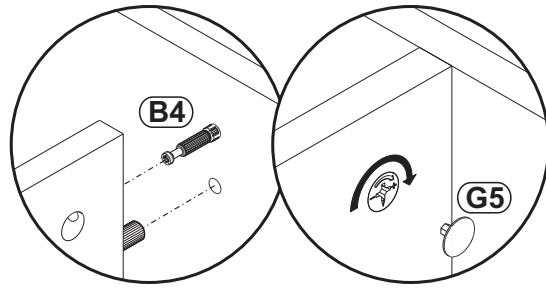

|    |   |
|----|---|
| G5 |  |
| x4 |   |

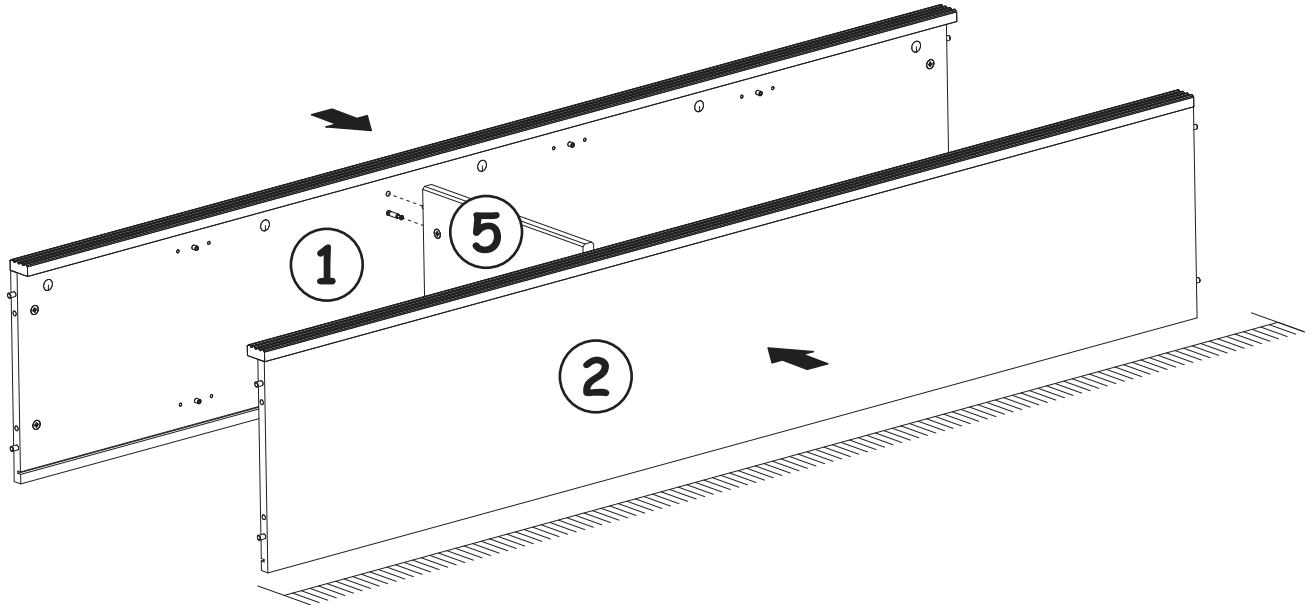

13

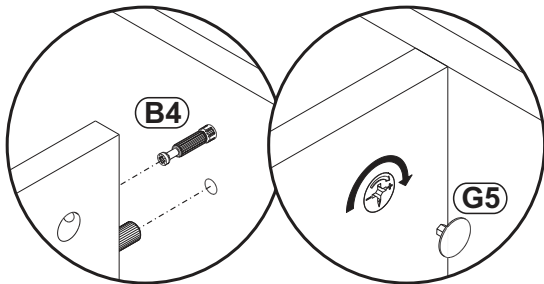

|    |   |
|----|---|
| G5 |  |
| x4 |   |

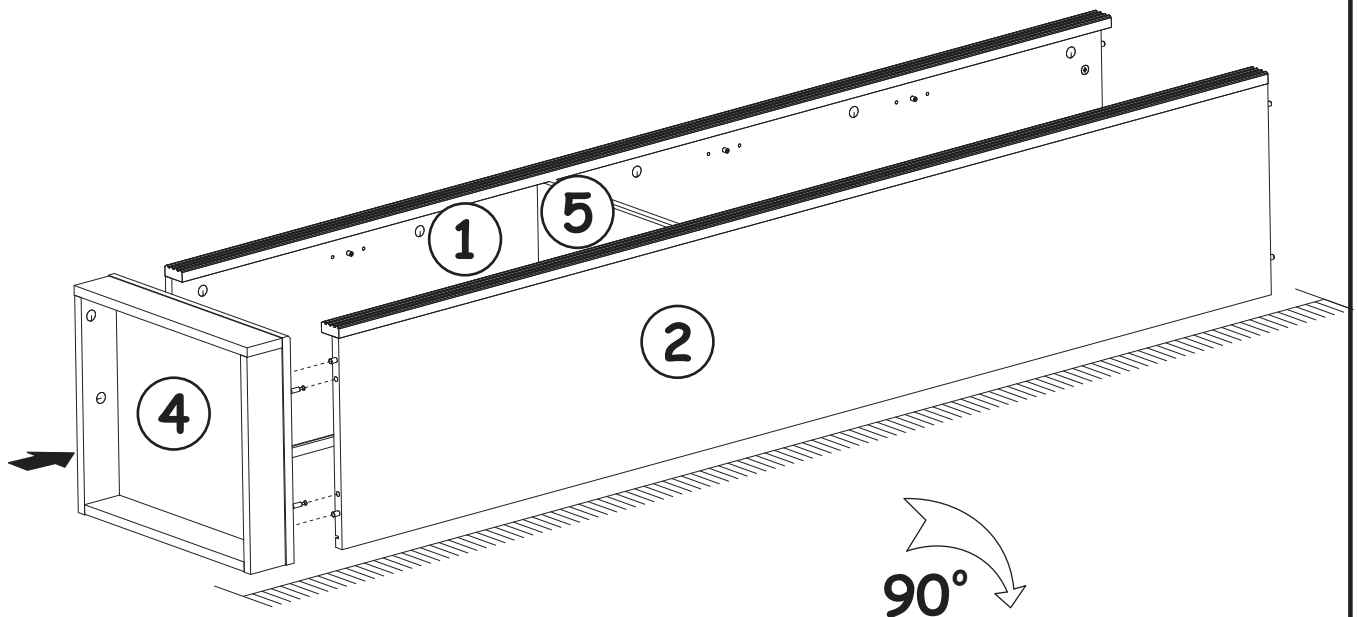

14

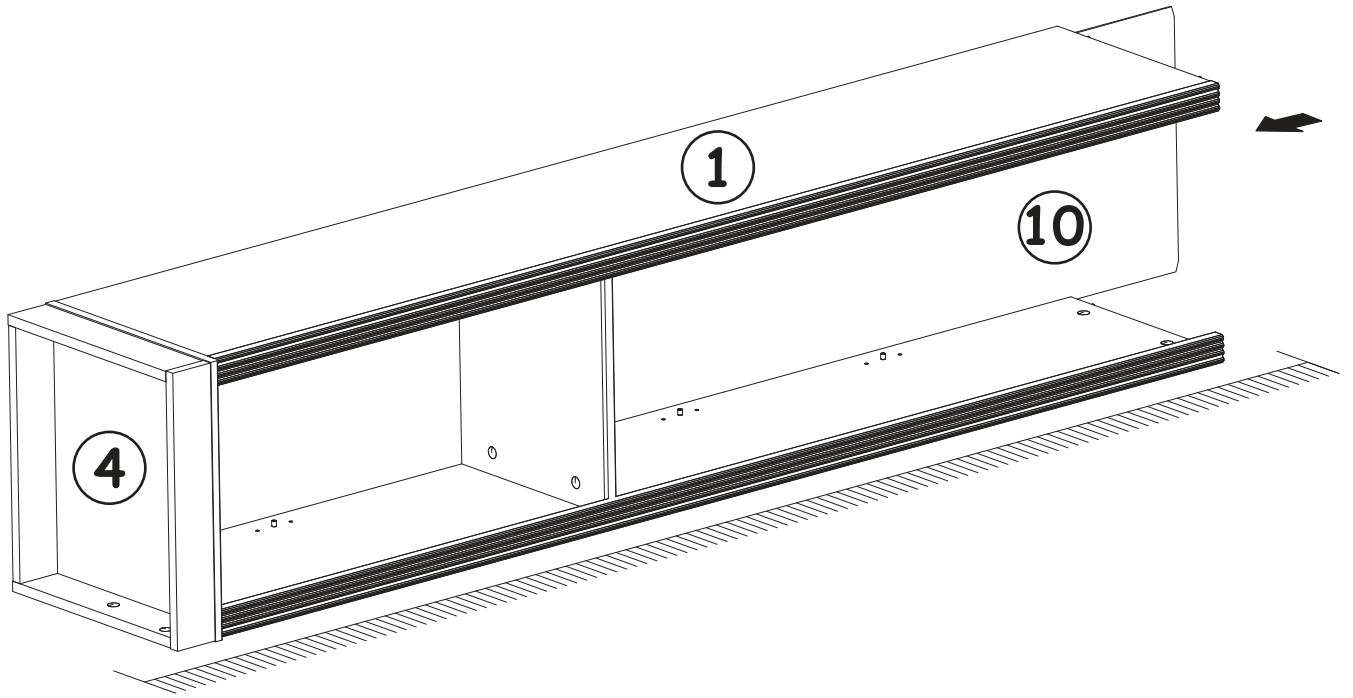

15

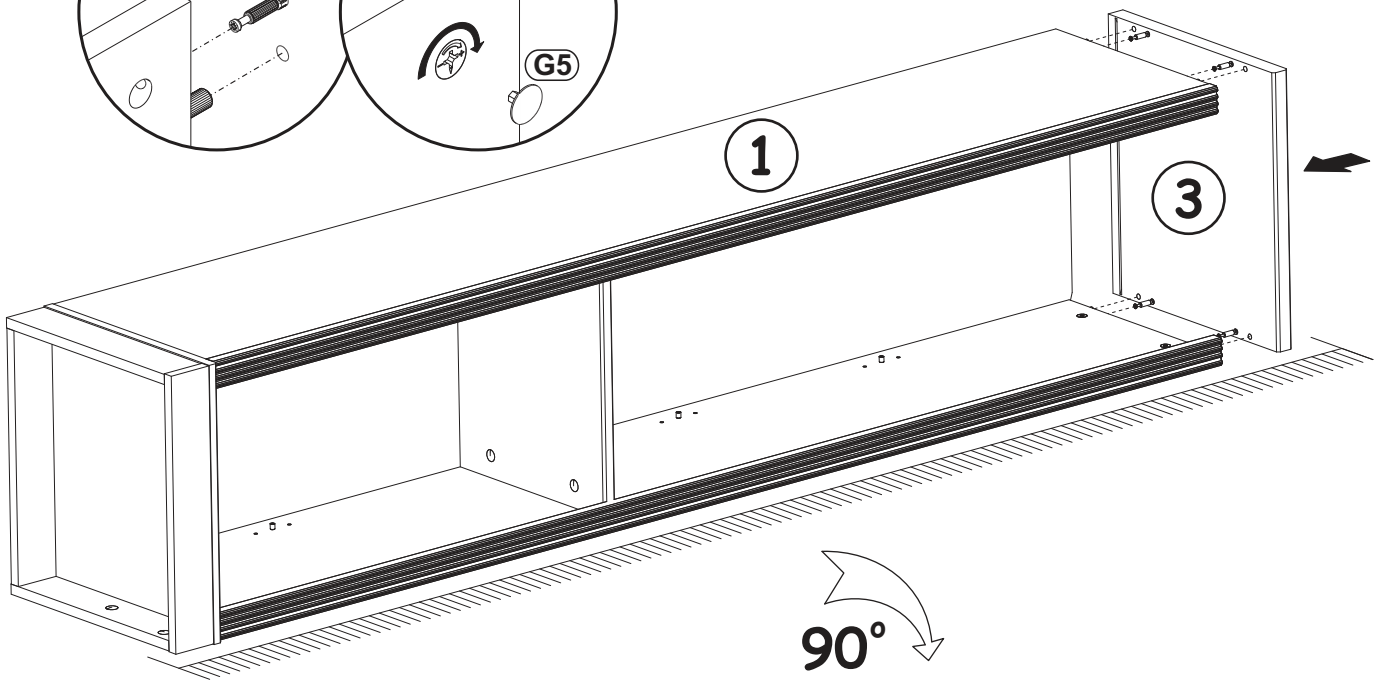
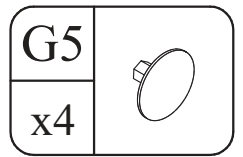
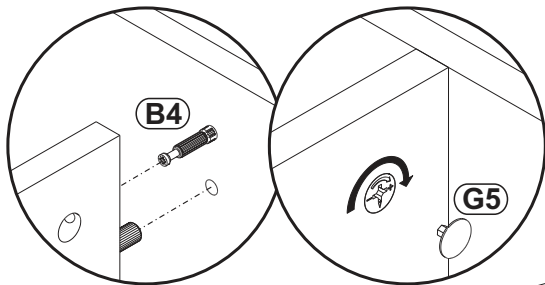

16

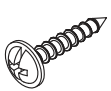
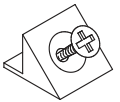

|      |   |     |   |
|------|---|-----|---|
| UP13 |  | S1  |  |
| x2   | UPØ3x16   | x14 |   |

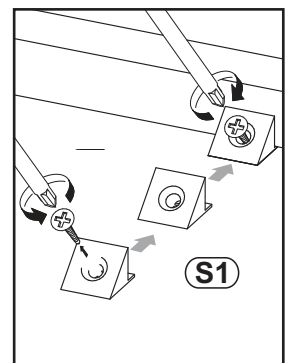
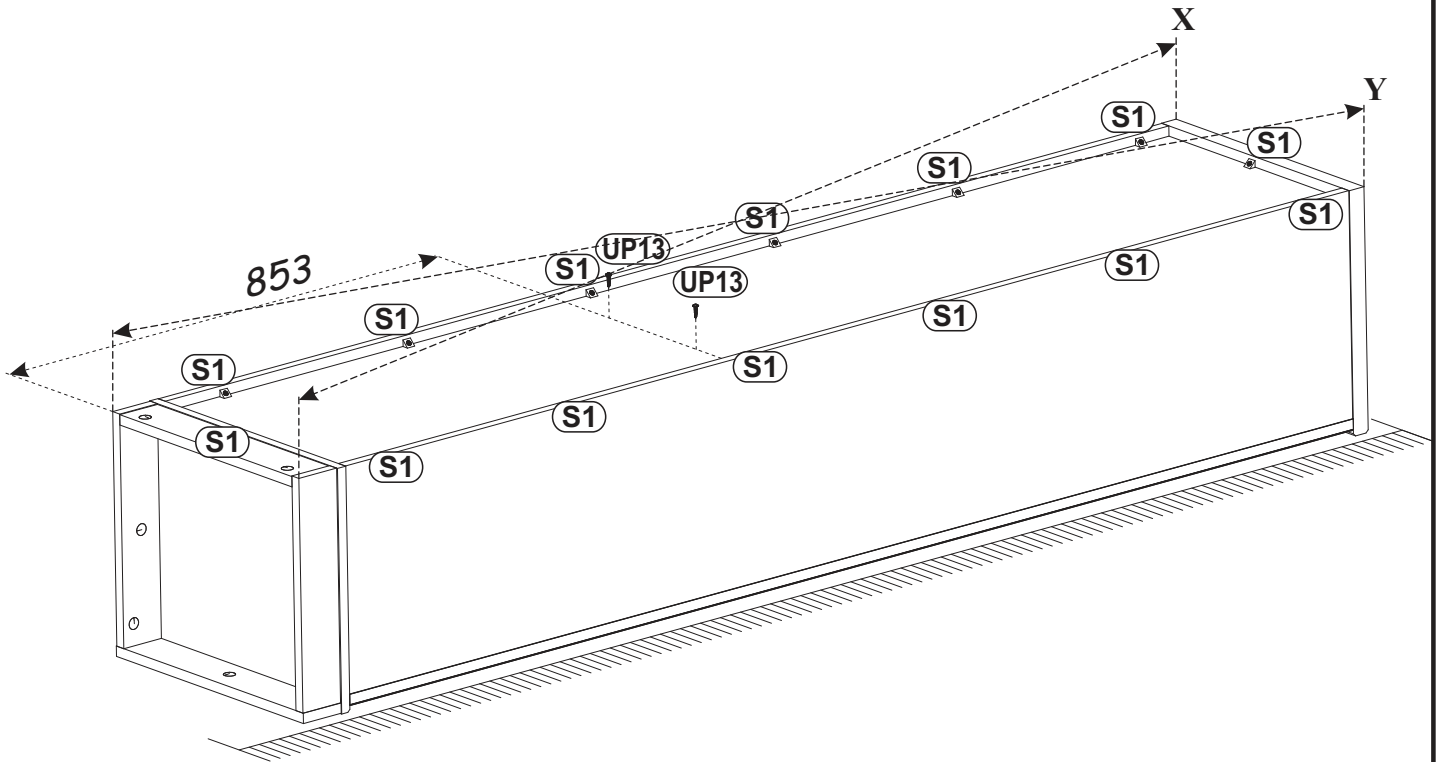
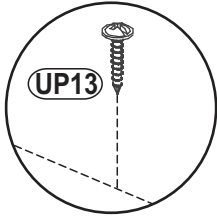

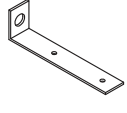
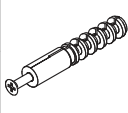
|     |  |    |   |     |   |
|-----|--|----|---|-----|---|
| D10 |  | L1 |  | KR1 |  |
| x2  | USØ3,5x13  | x1 |   | x1  |   |

17

