

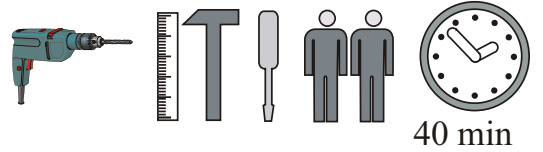

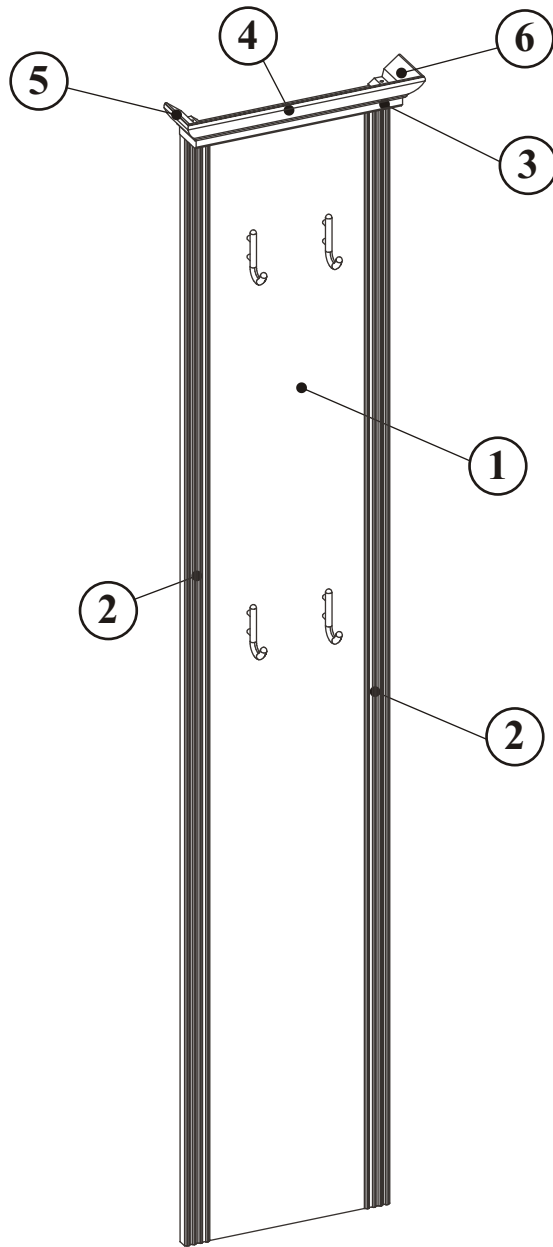







JASMIN 30B1_40

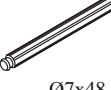
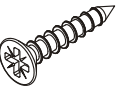

NO	Dim.			Col.-No	Qty
1	1892	262	16	1	1
2	1892	43	19	1	2
3	350	60	16	1	1
4	403	67	22	1	1
5	86	67	22	1	1
6	86	67	22	1	1

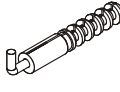
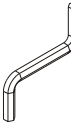
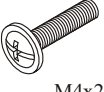
A1 x3  ø8x36	A3 x10  ø8x47	B5 x24  ø15x12	G5 x24 	B9 x12  ø7x48	D9 x7  USØ3x20
B11 x2  ø7x50	G4 x2 	D28 x6  ESØ6x9,5	KR2 x3 	G2 x1 	D5 x8  M4x25
W23 x4 	ZM1 x3 				

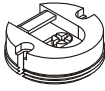
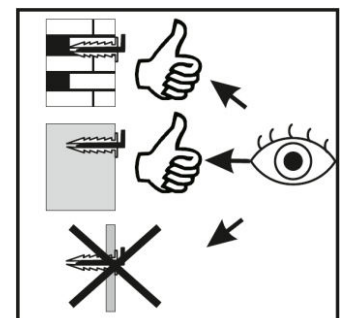
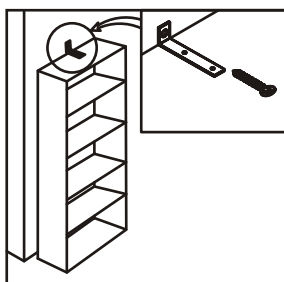
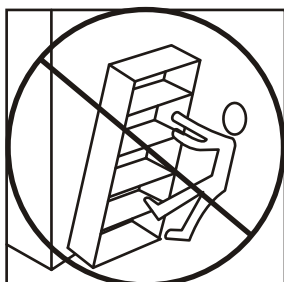
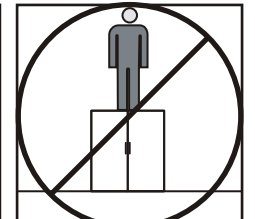
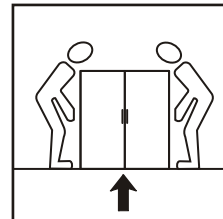
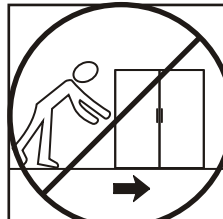
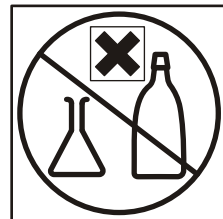
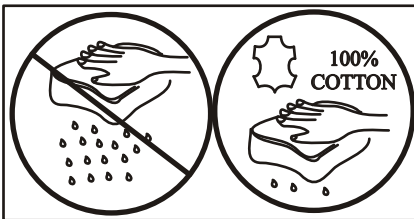
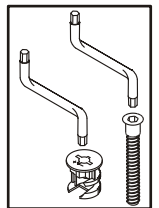
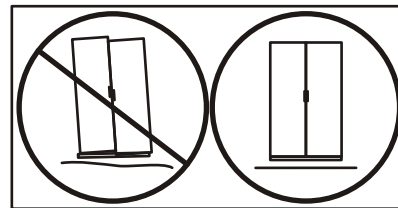
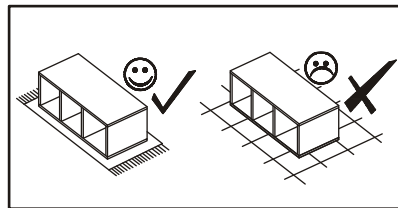
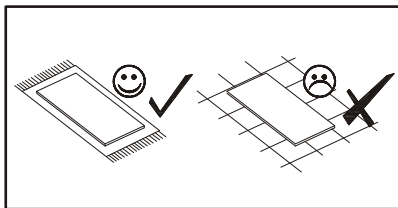
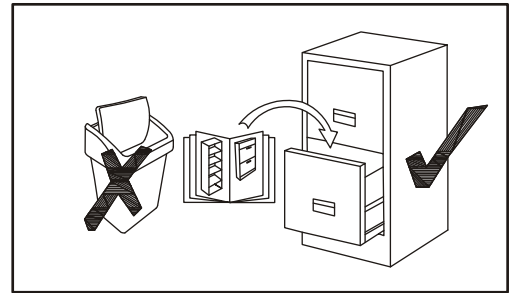
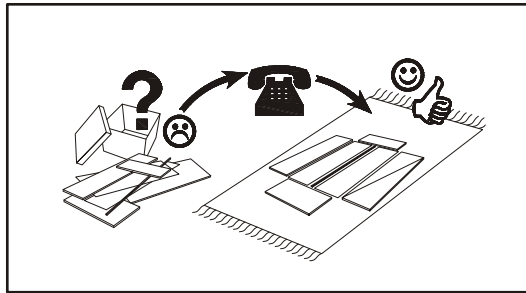
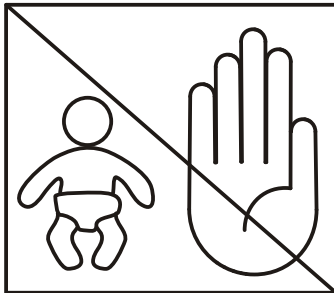
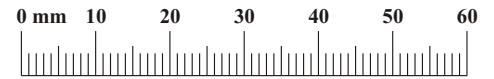

1

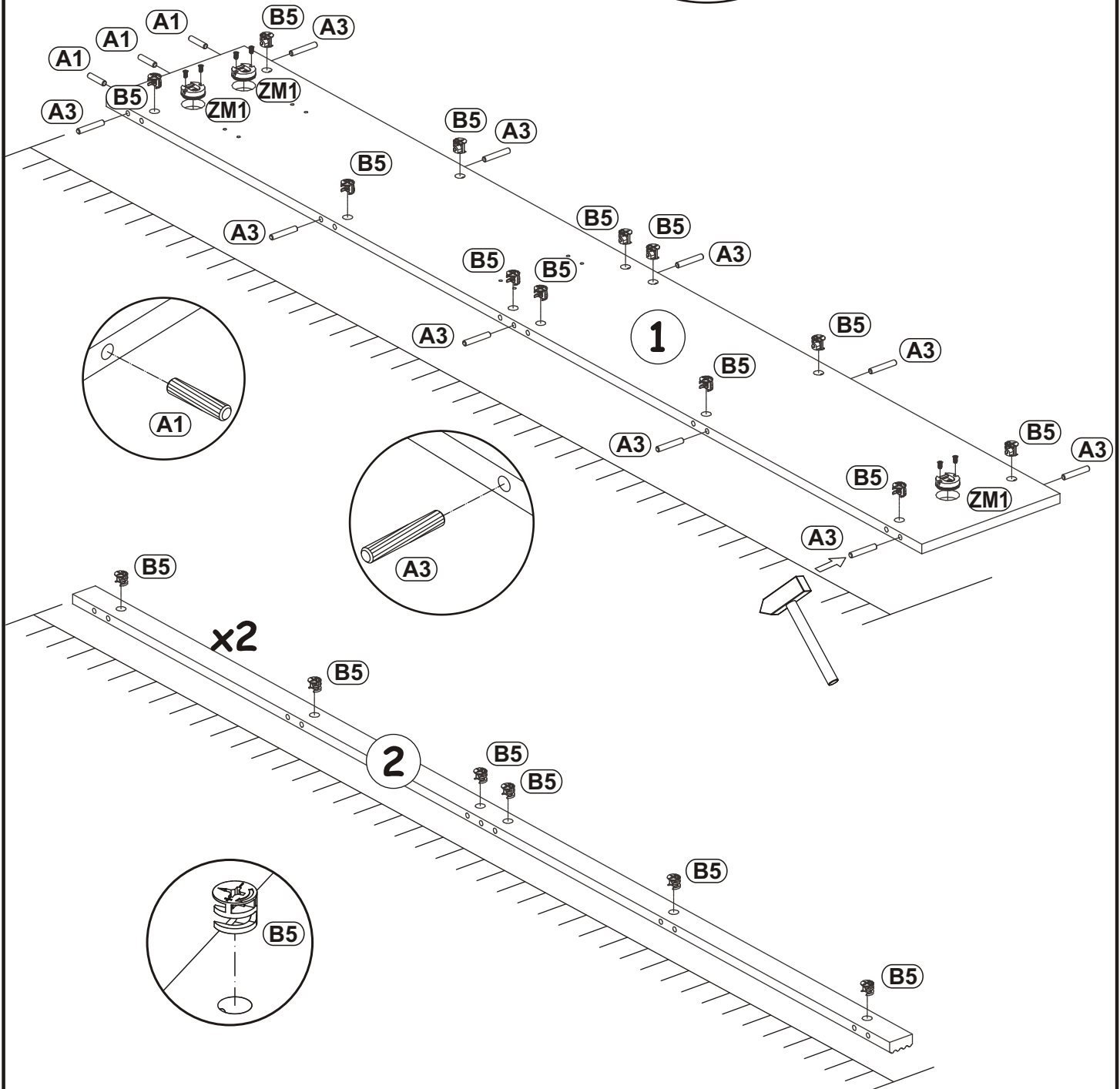
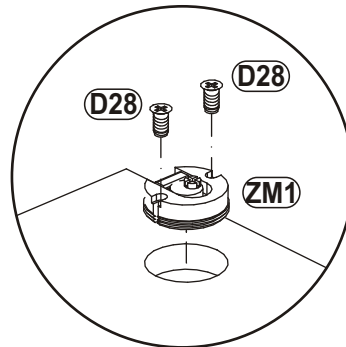
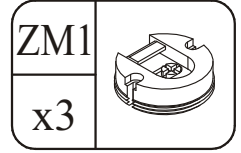
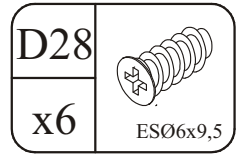
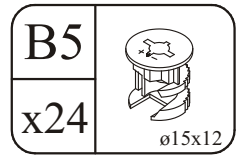
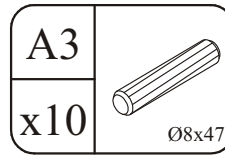
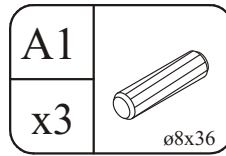
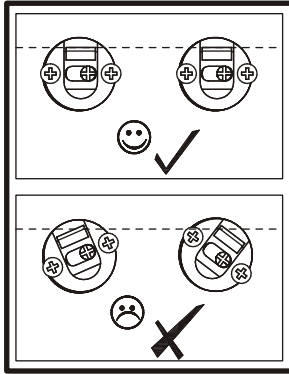

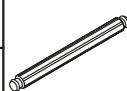
B9	
x12	Ø7x48

G5	
x24	

2

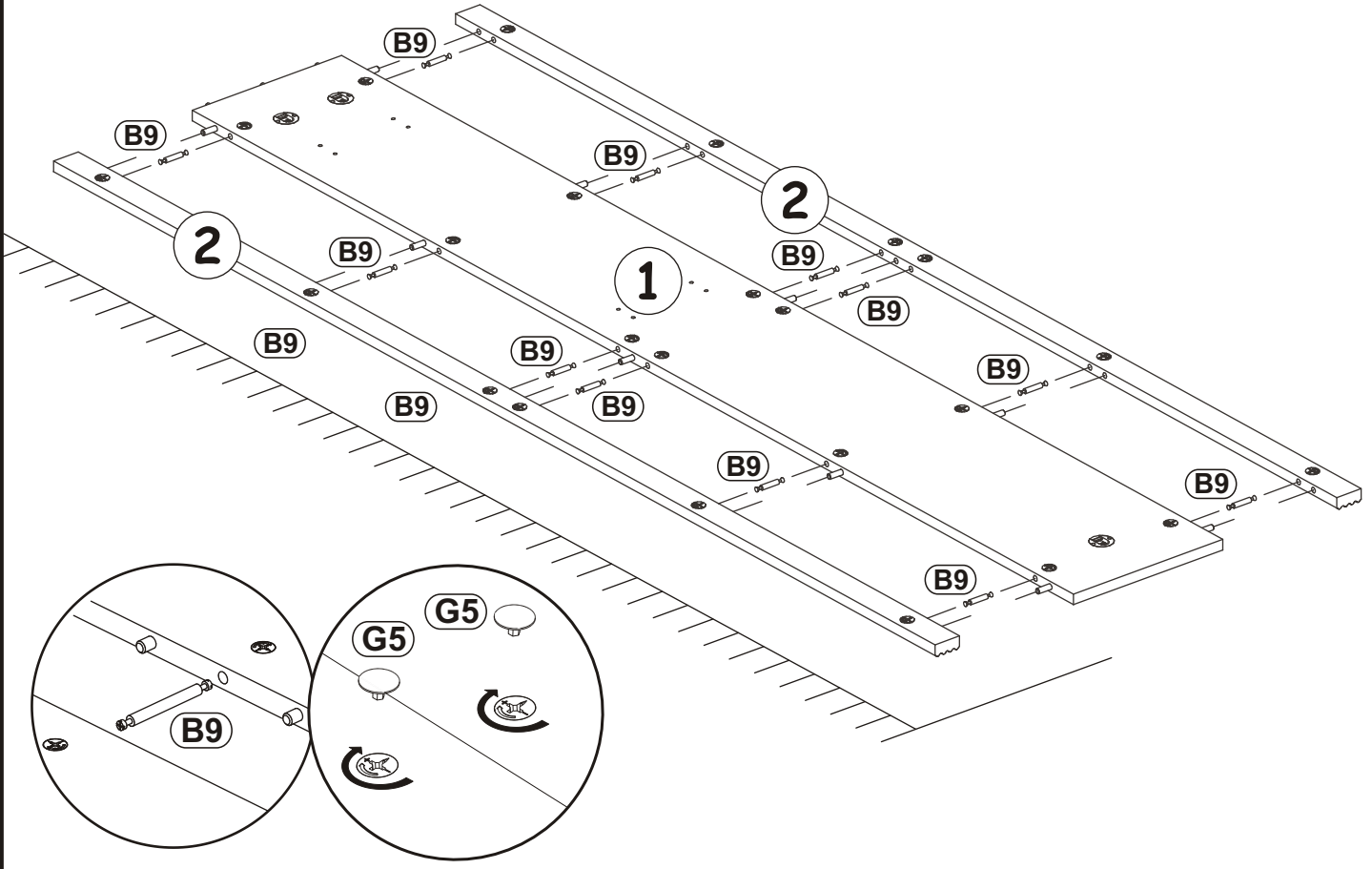



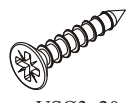

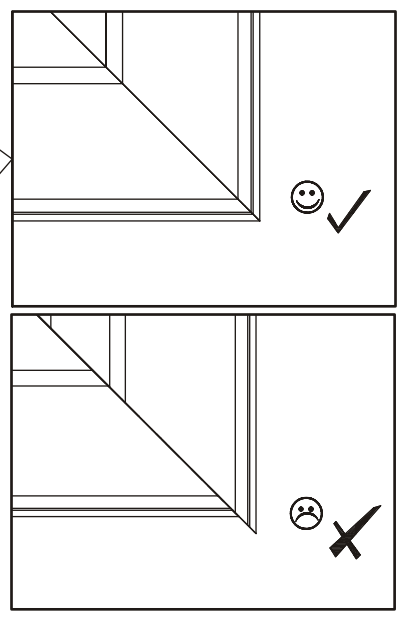
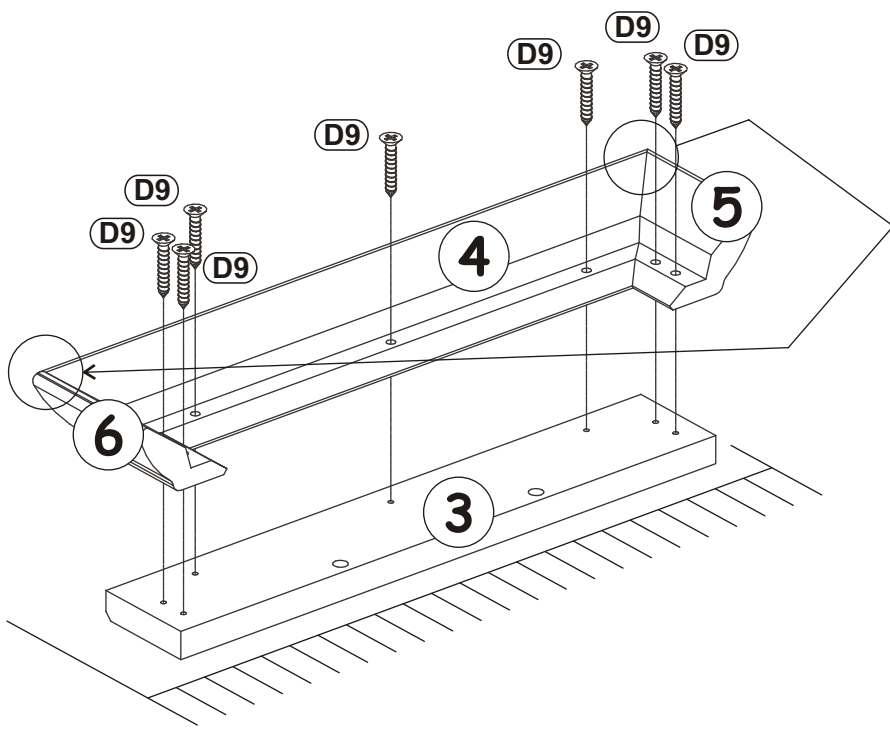
3

D9	
x7	USØ3x20



4

B11		G4	
x2	Ø7x50	x2	
W23		D5	
x4		x8	M4x25

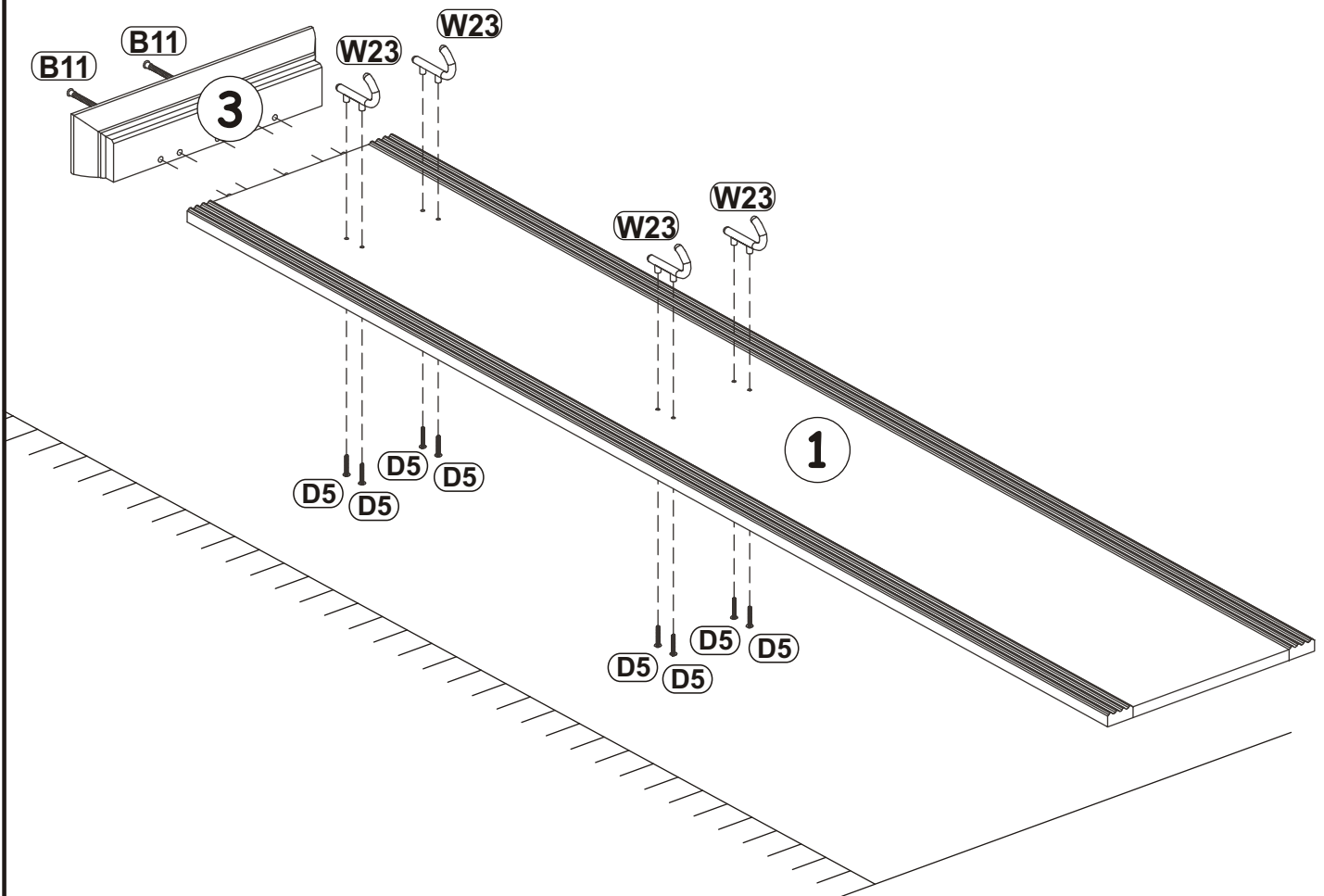
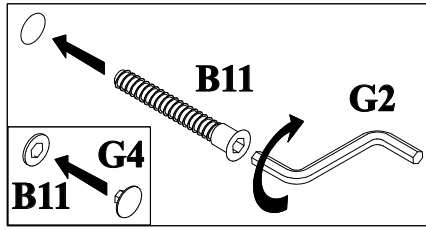

KR2
x3

5

