

A	B	C (mm)		D
1	S246-1009	1988	351	2/2
2	S246-2007	650	351	1/2
3	S246-2008	650	351	1/2
4	S246-3009	617	331	1/2
5	S246-3010	617	331	1/2
6	S246-3011	616	321	1/2
7	S246-5501	362	226	1/2
8	S246-5551	362	354	1/2
9	S246-7005	1988	150	2/2
10	S246-7006	302	201	2/2
11	S246-7007	541	201	2/2
12	S246-7008	541	201	2/2
13	S246-7301	218	218	2/2
14	S246-7801	2016	646	2/2
15	S246-9007	1998	627	2/2

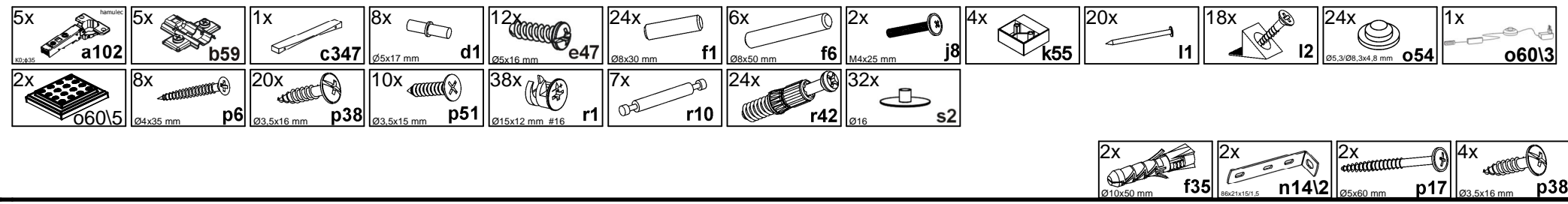

A

S246-REG1W/20/6

10A1--01

3 / 16

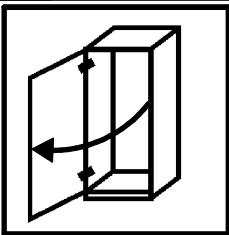

A

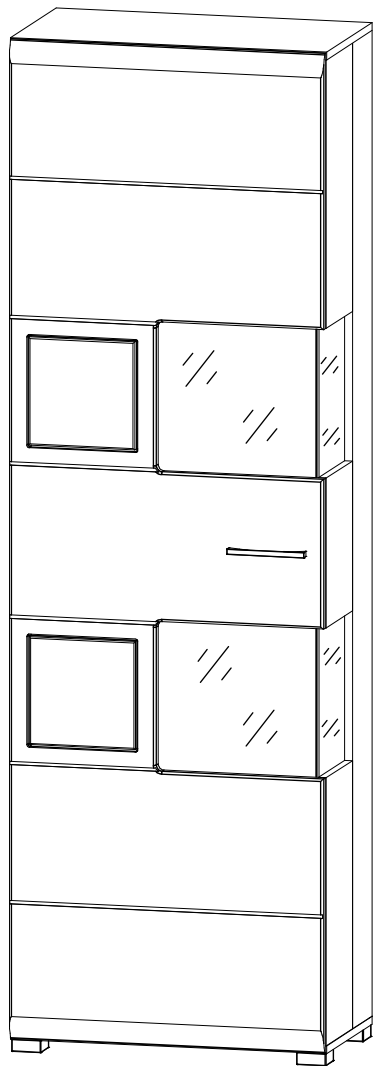

B

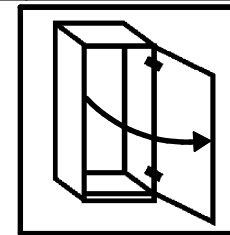

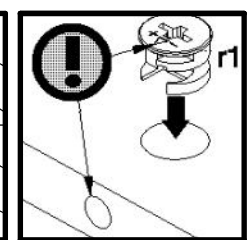
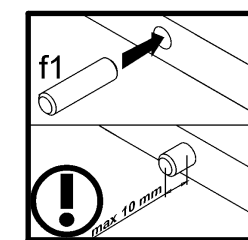
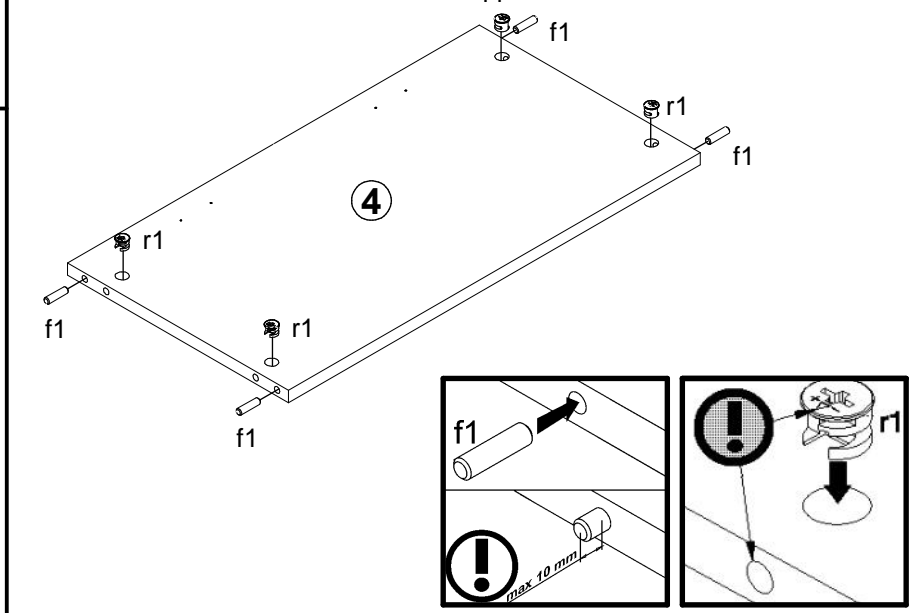
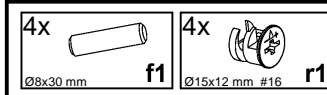
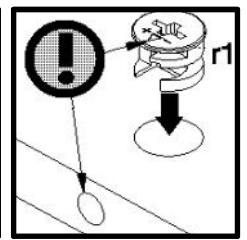
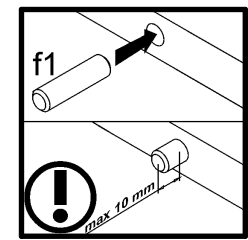
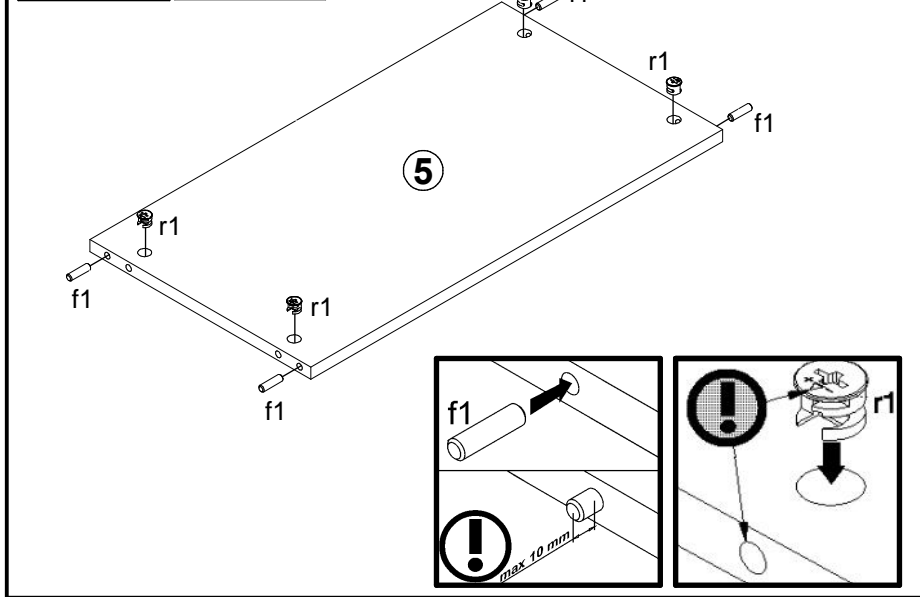
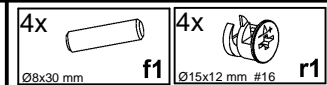
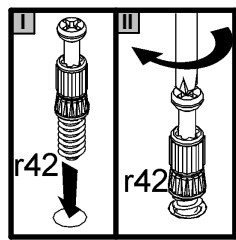
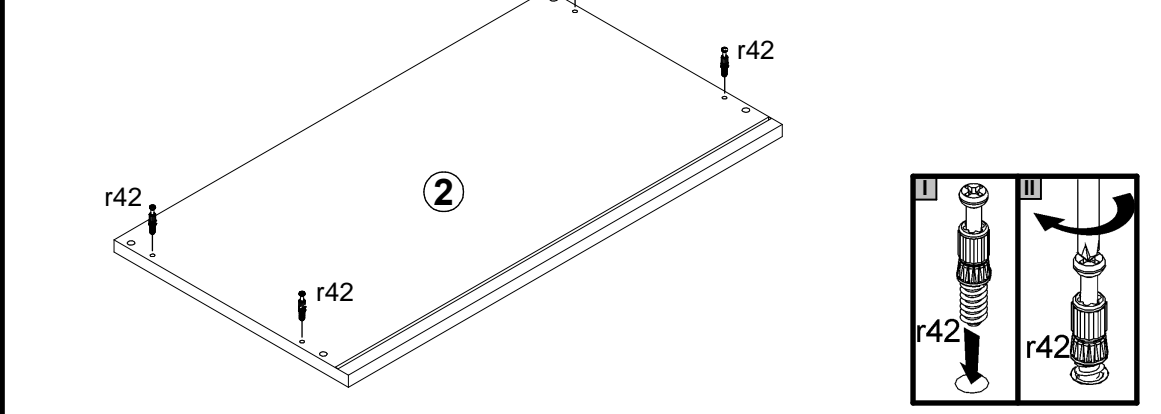
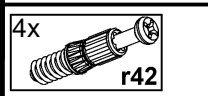
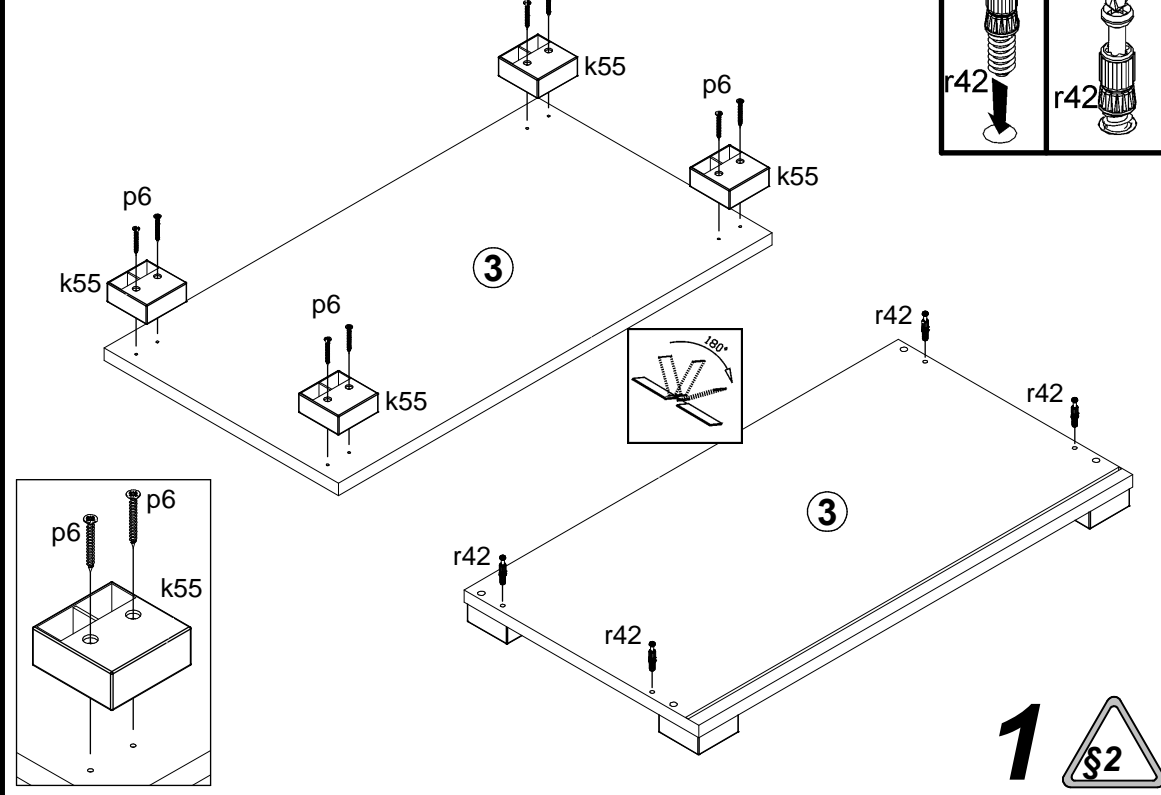
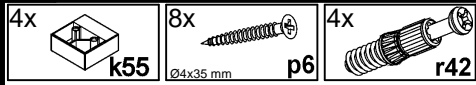

1

- 8x r42
- 4x f1
- 4x r1
- 5x b59
- 4x d1

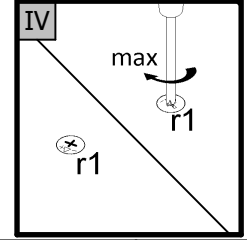
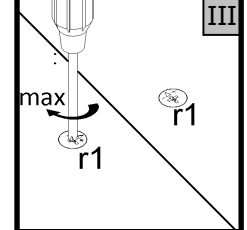
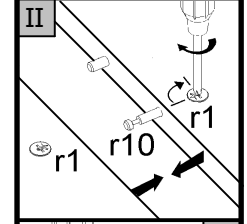
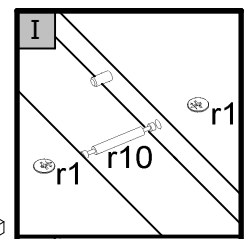
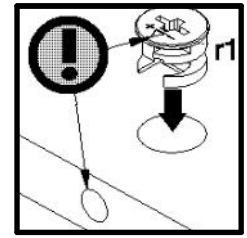
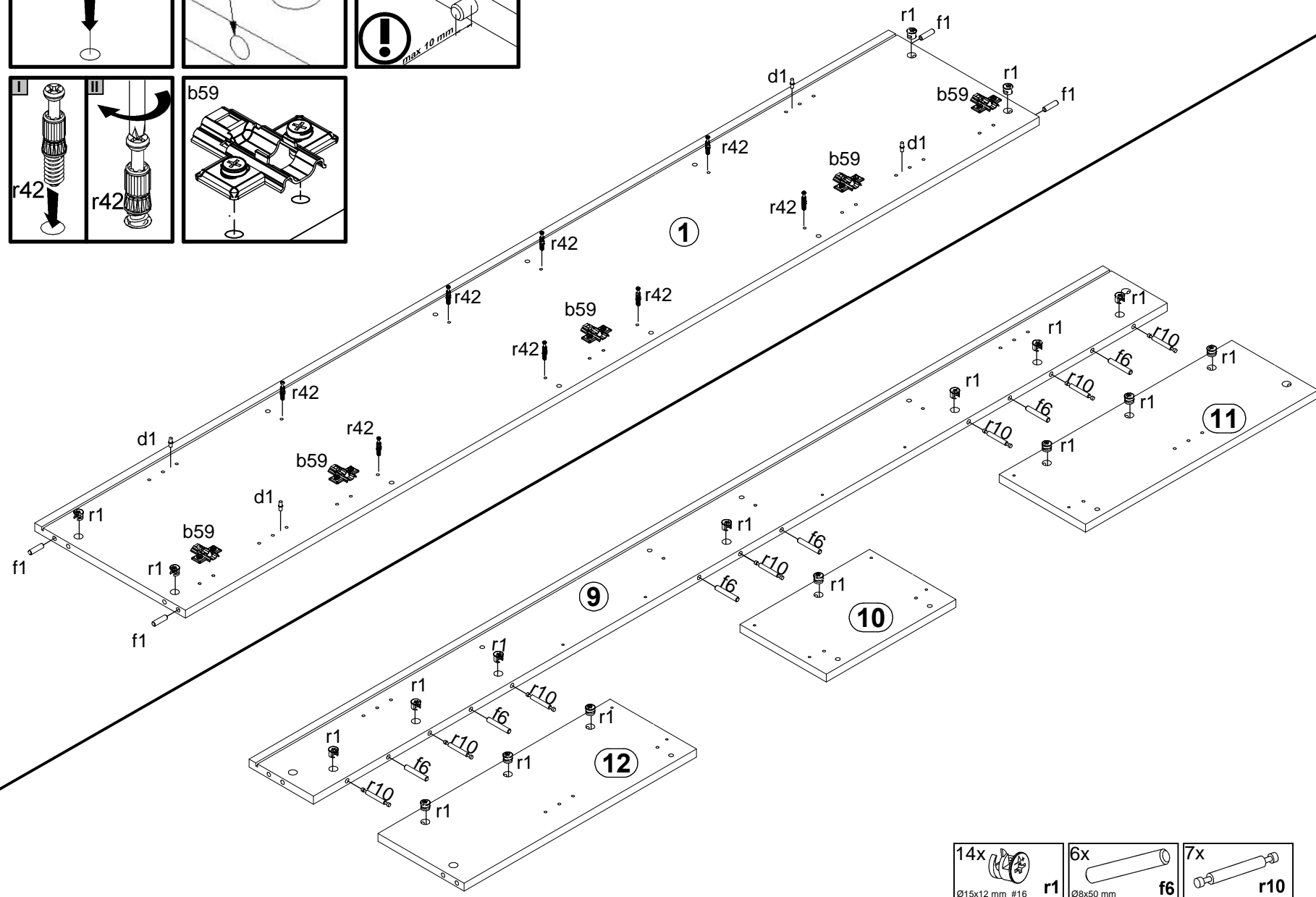
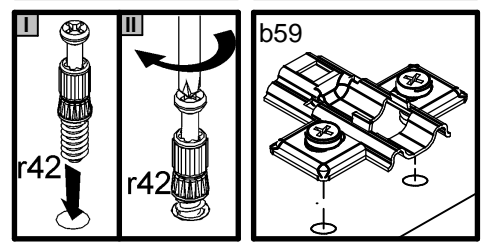
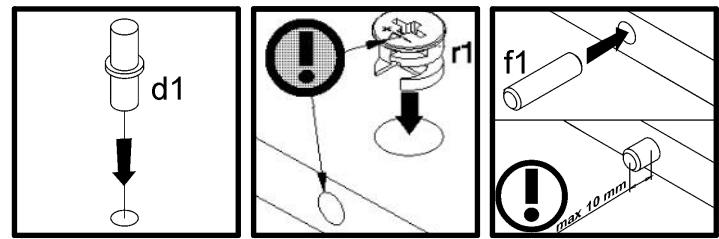

- 14x r1
- 6x f6
- 7x r10

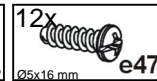
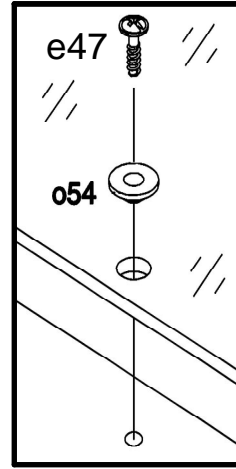
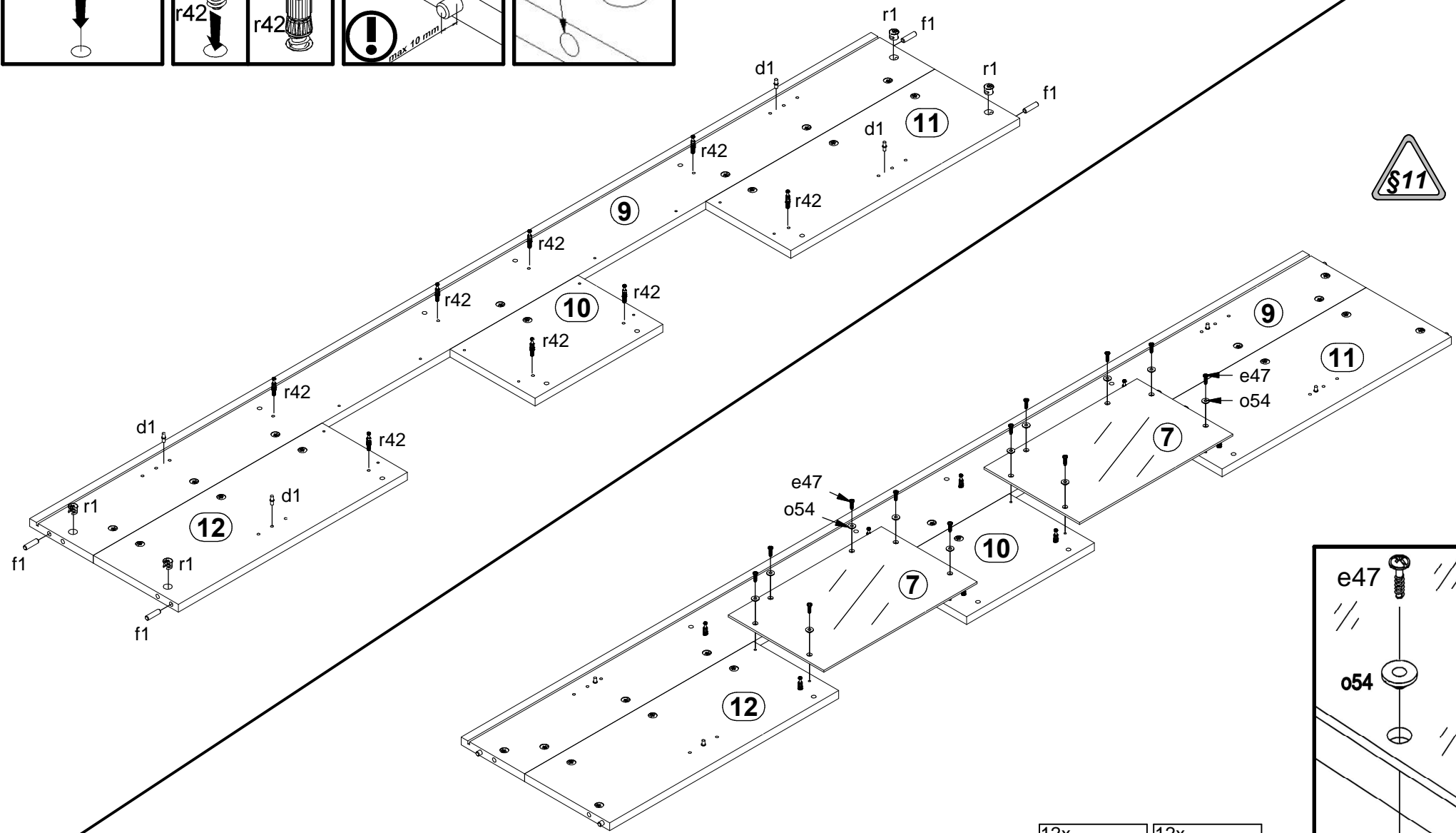
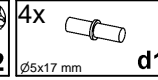
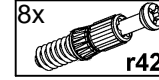
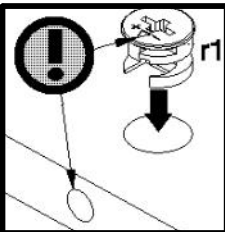
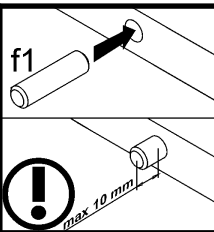
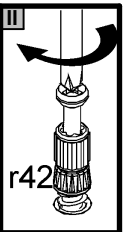
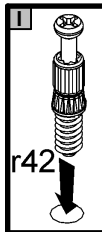
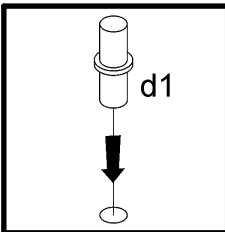

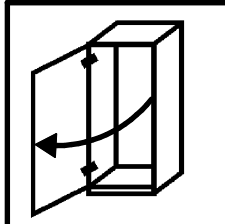

A



B

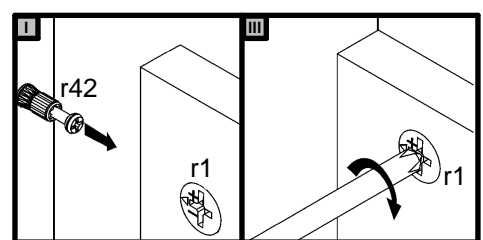
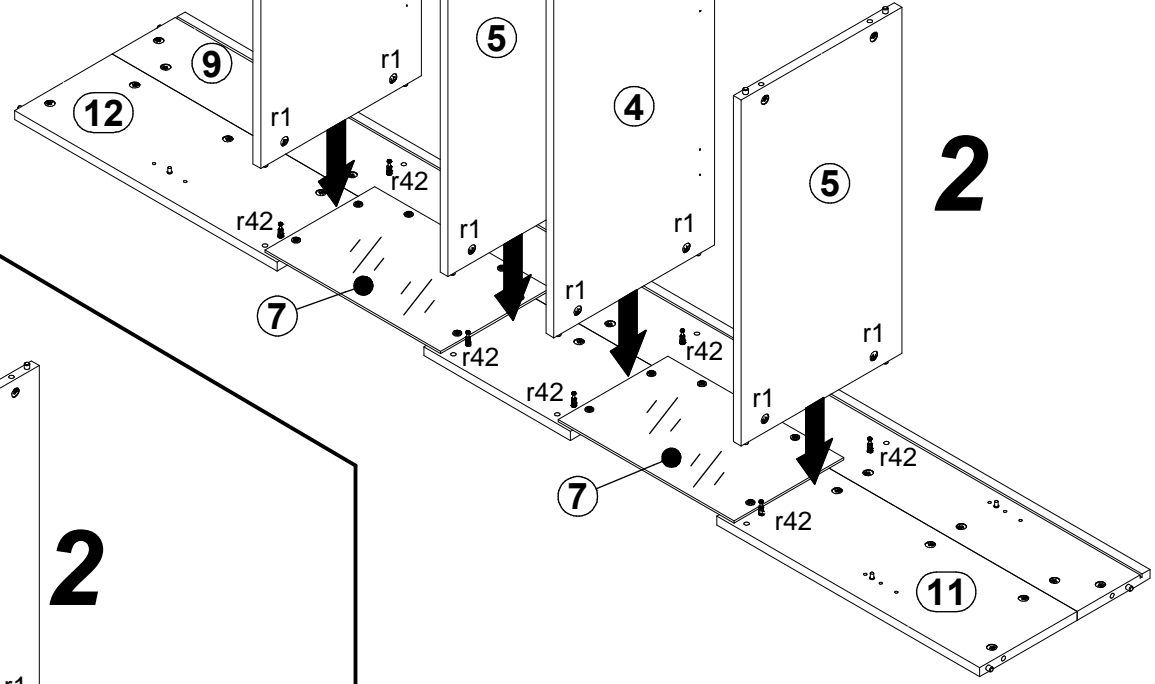
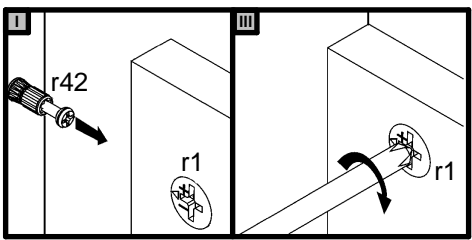
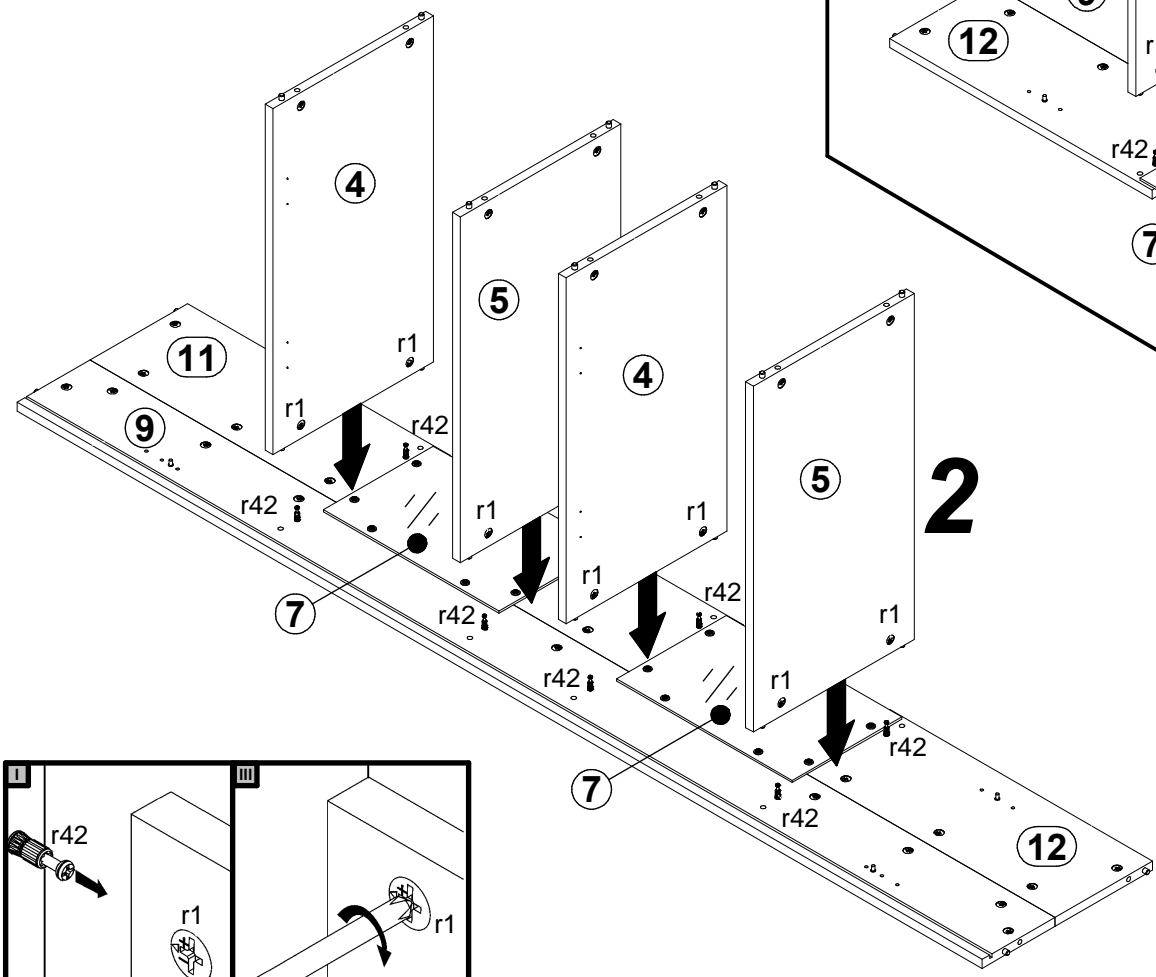
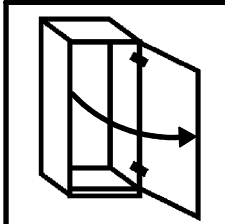



A

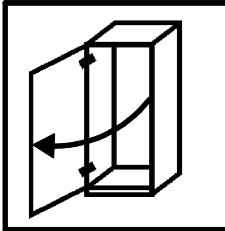

B

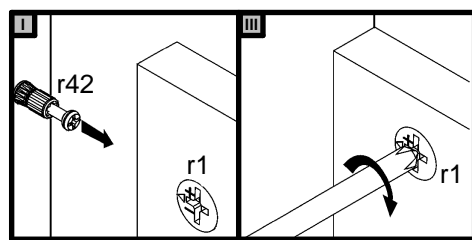
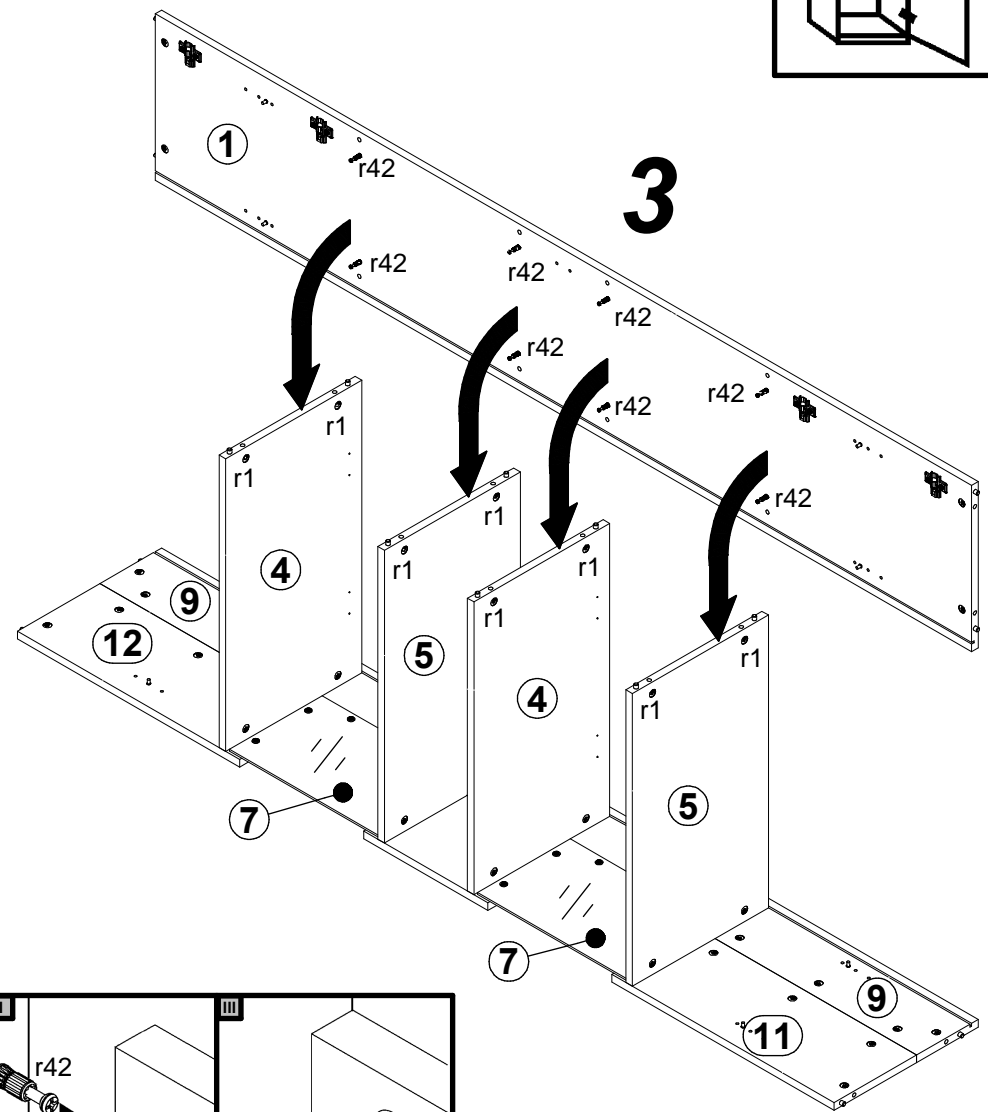
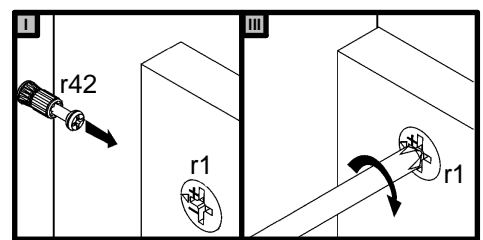
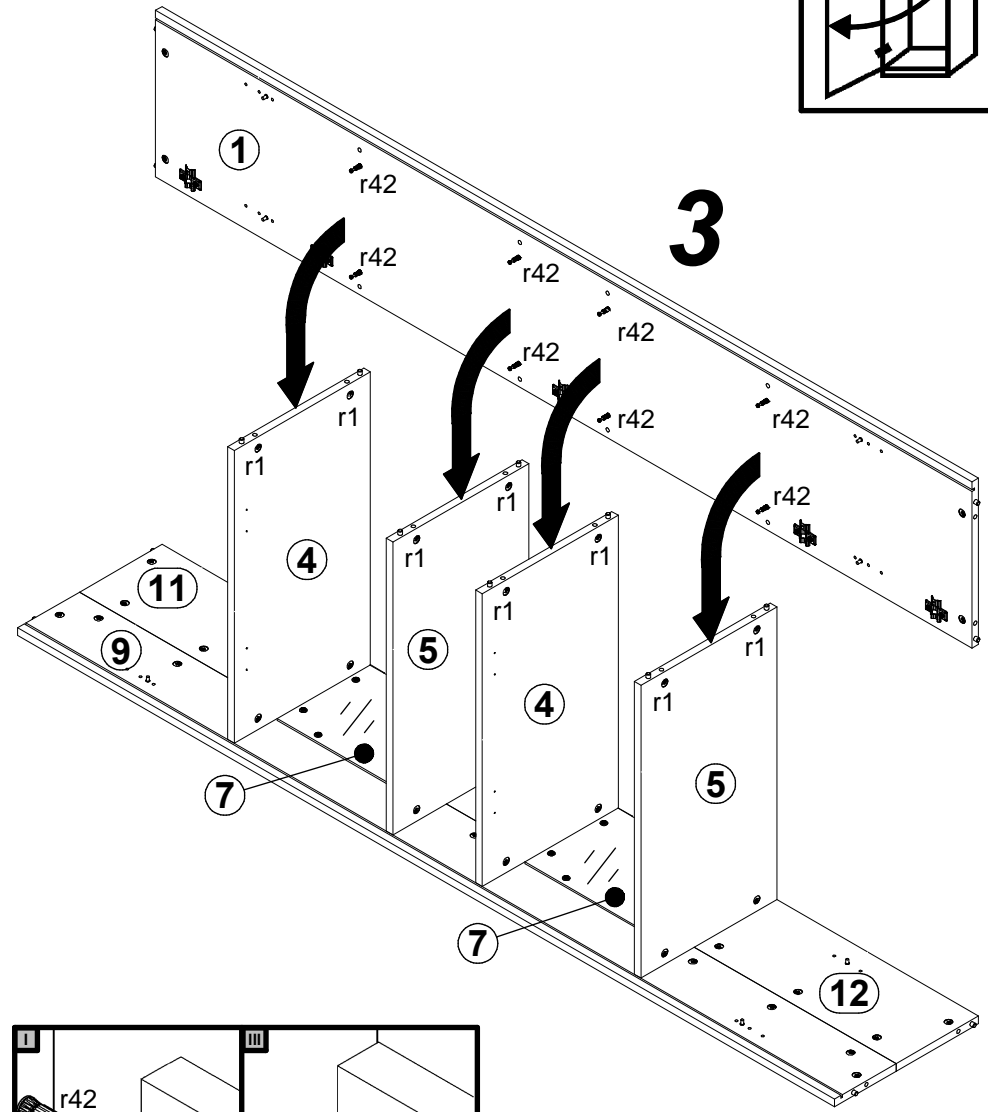
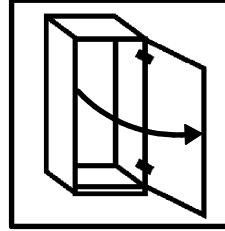



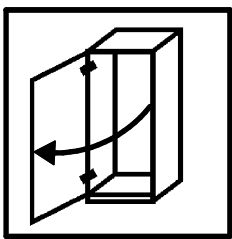

A



B

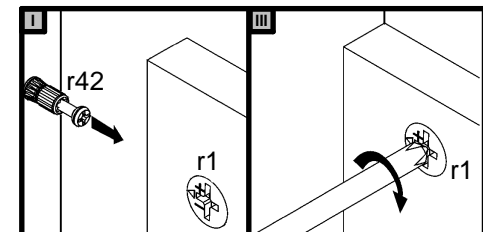
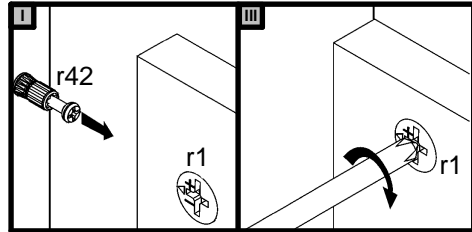
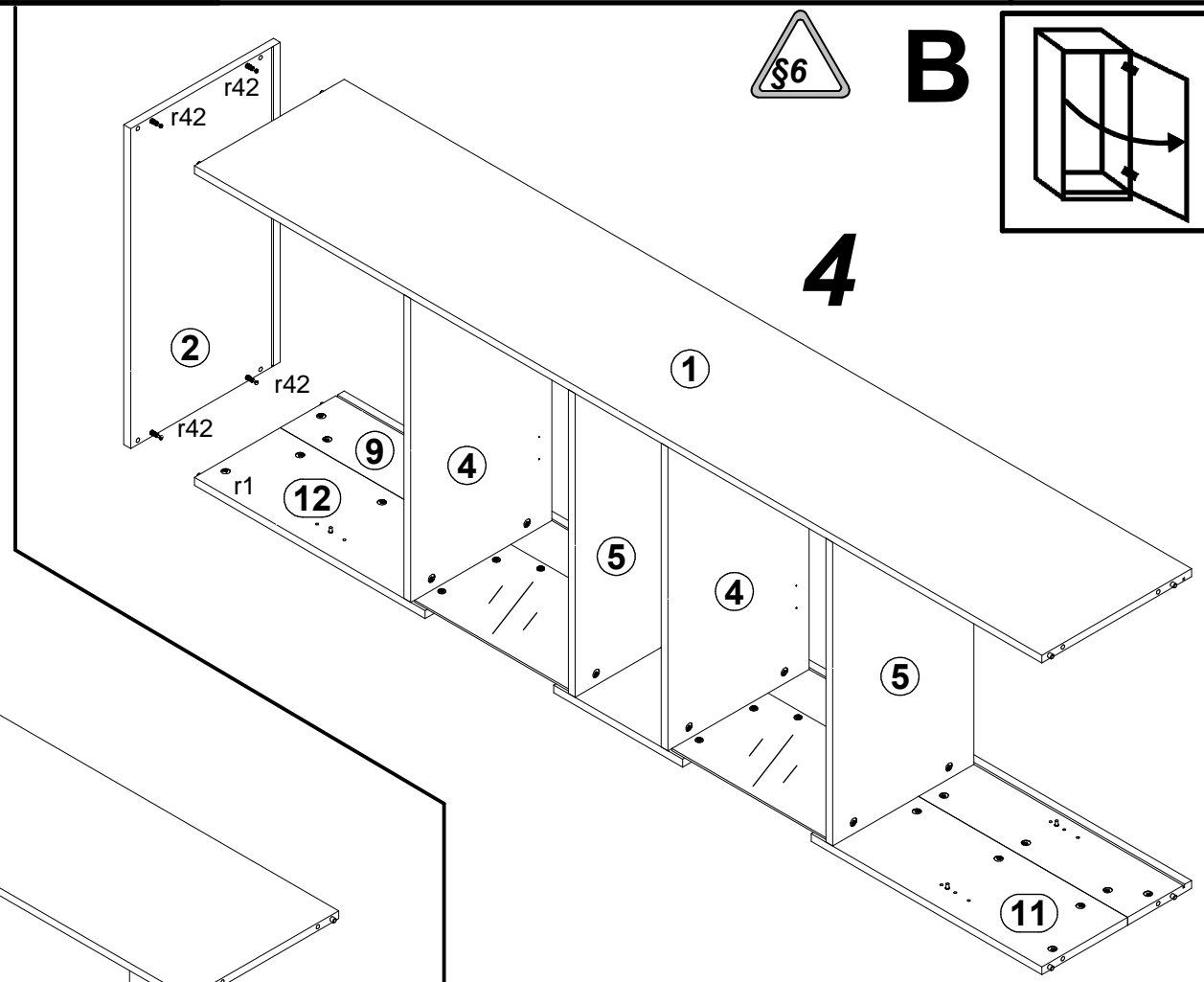
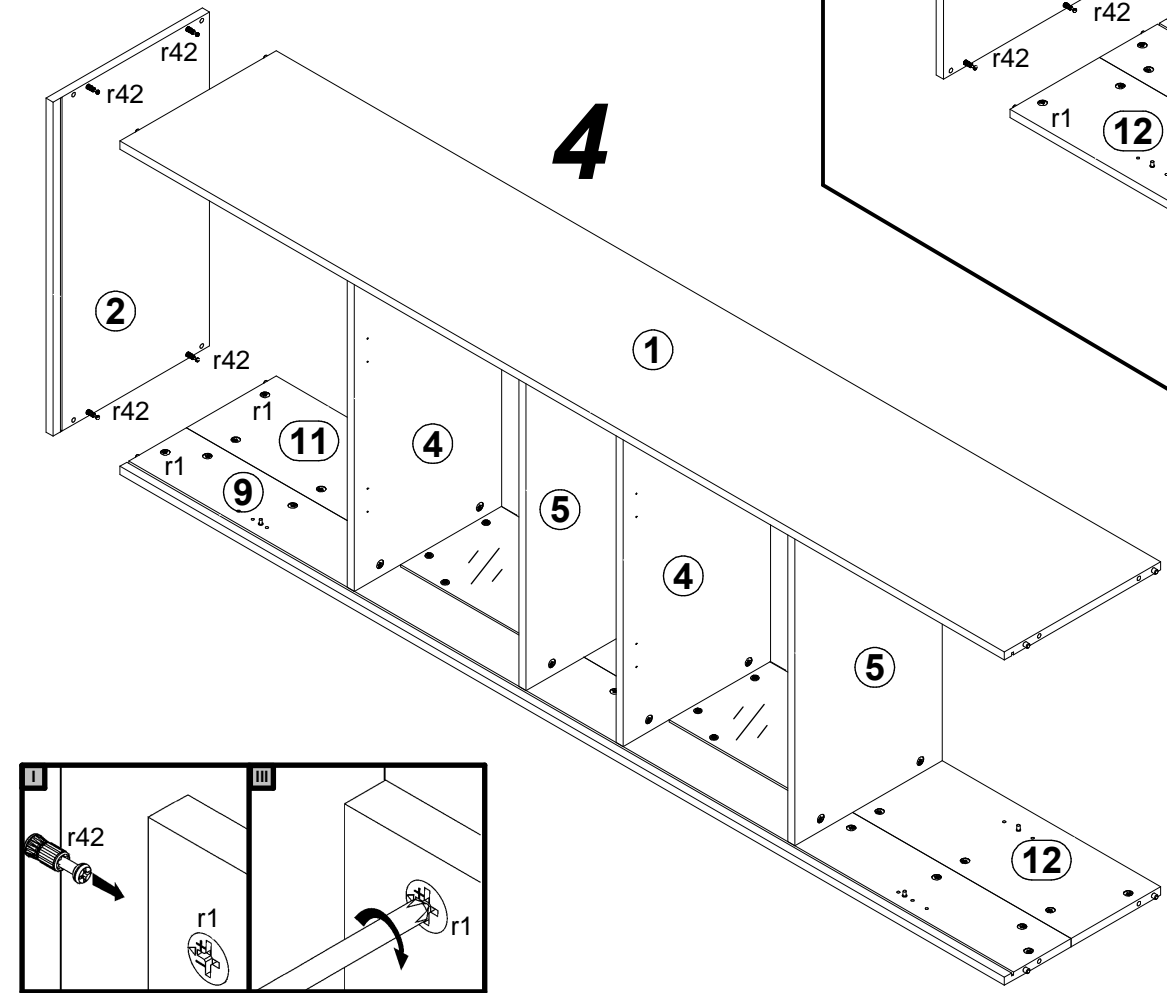
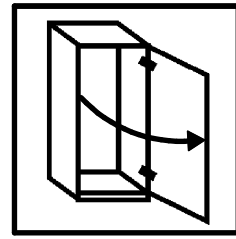

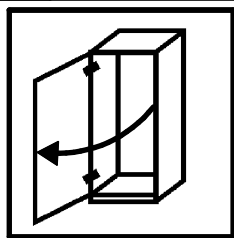

**A**

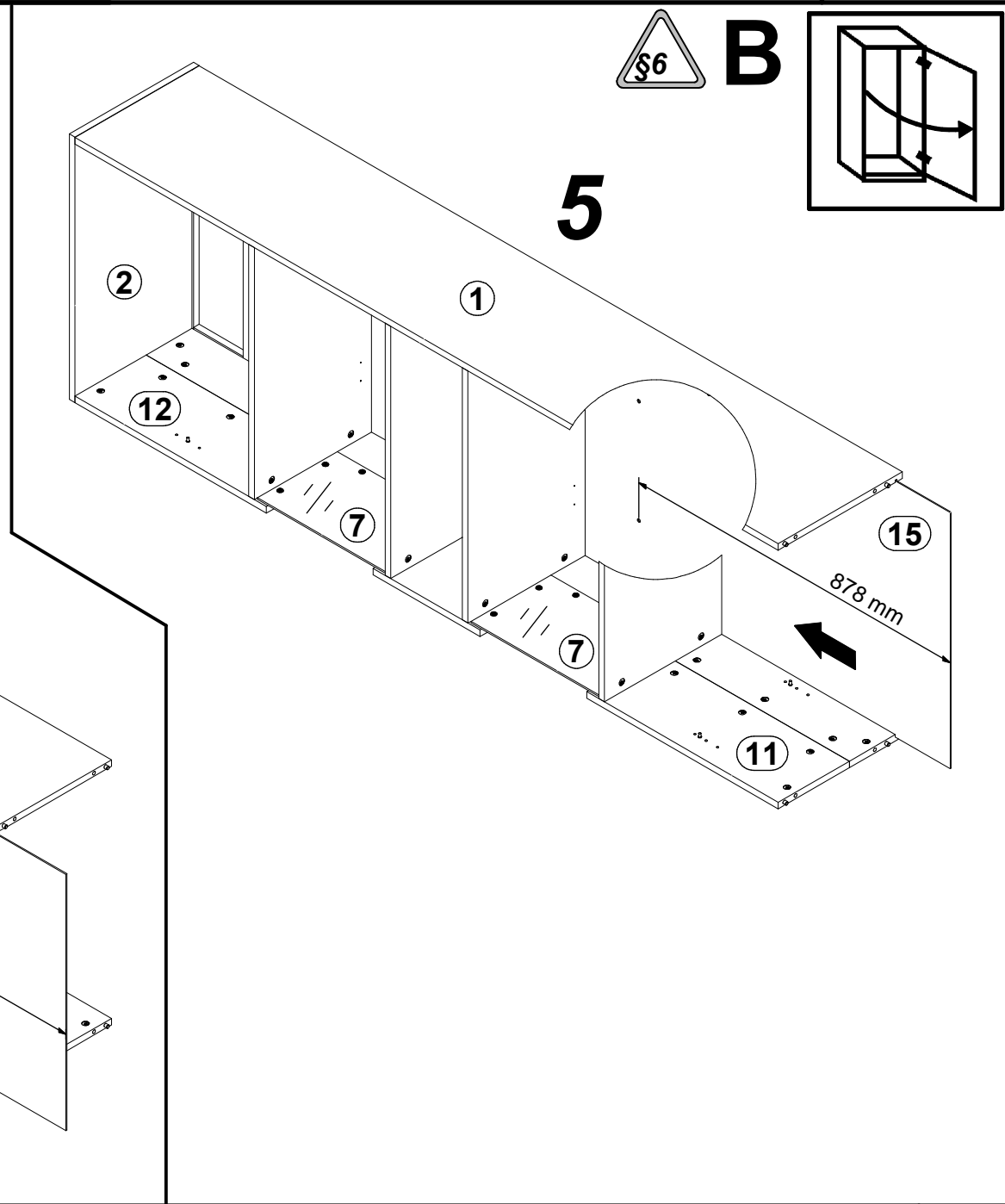

**B**

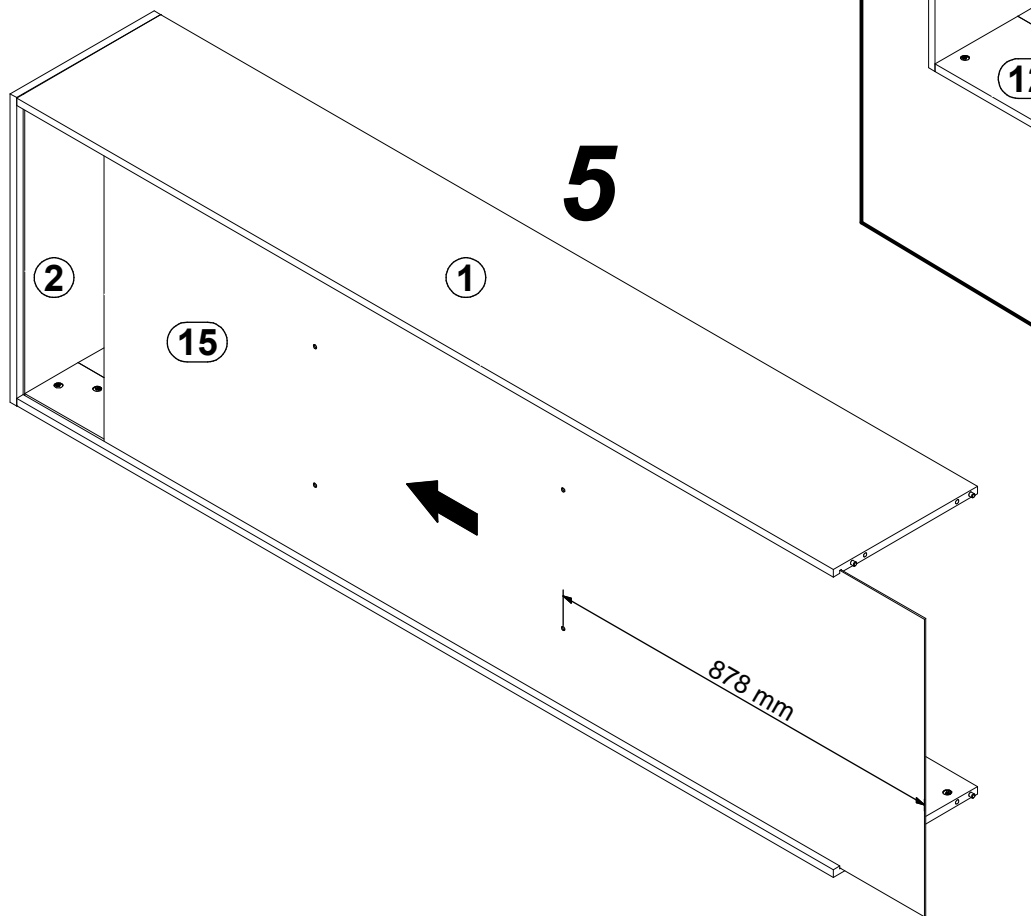
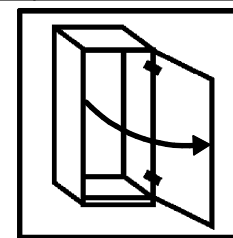

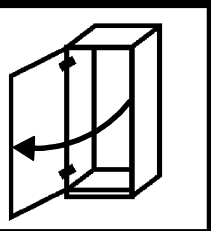

**A** 

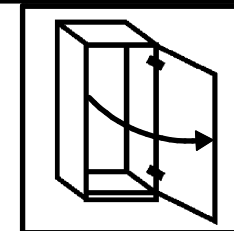

 **B**

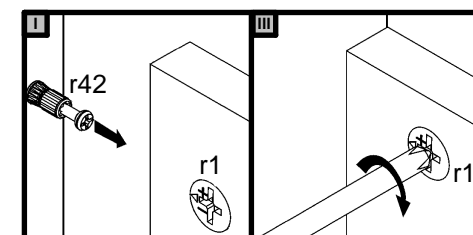
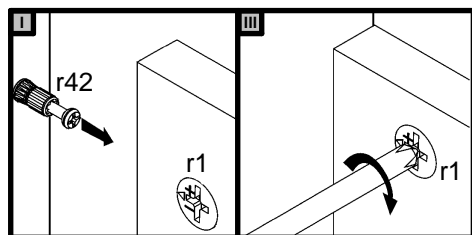
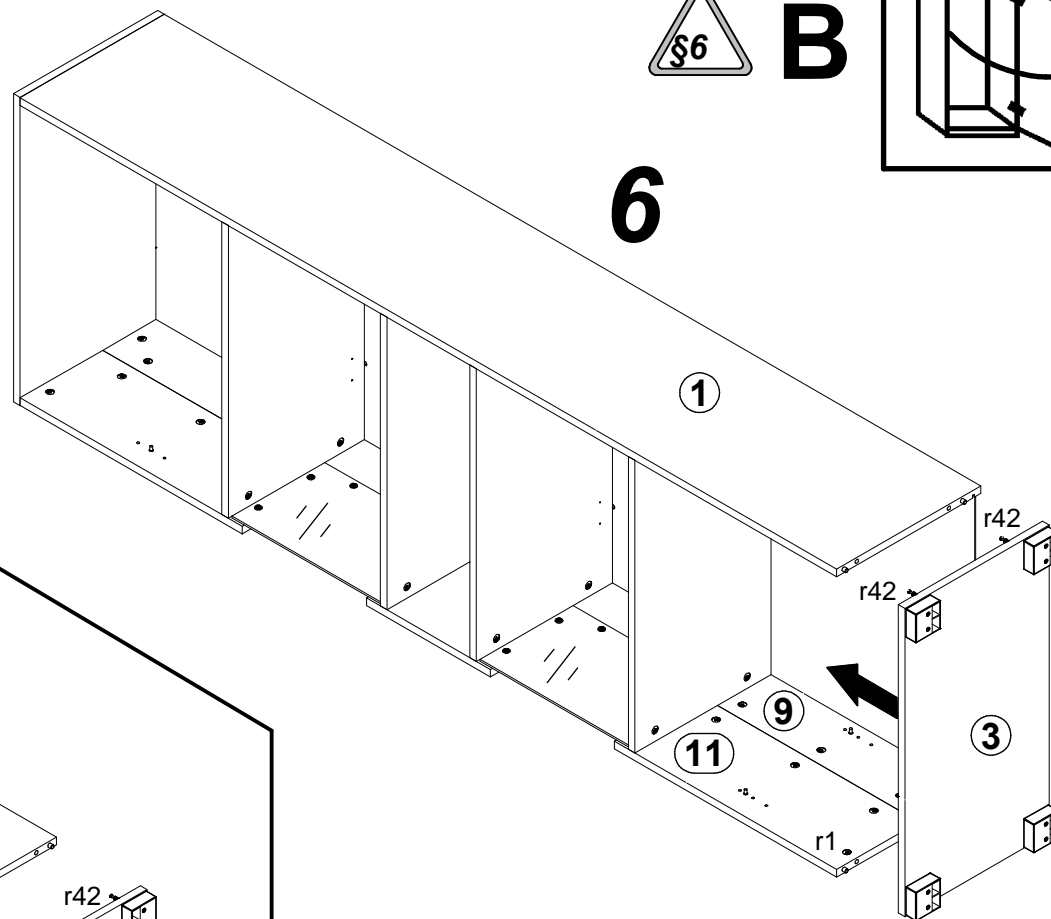
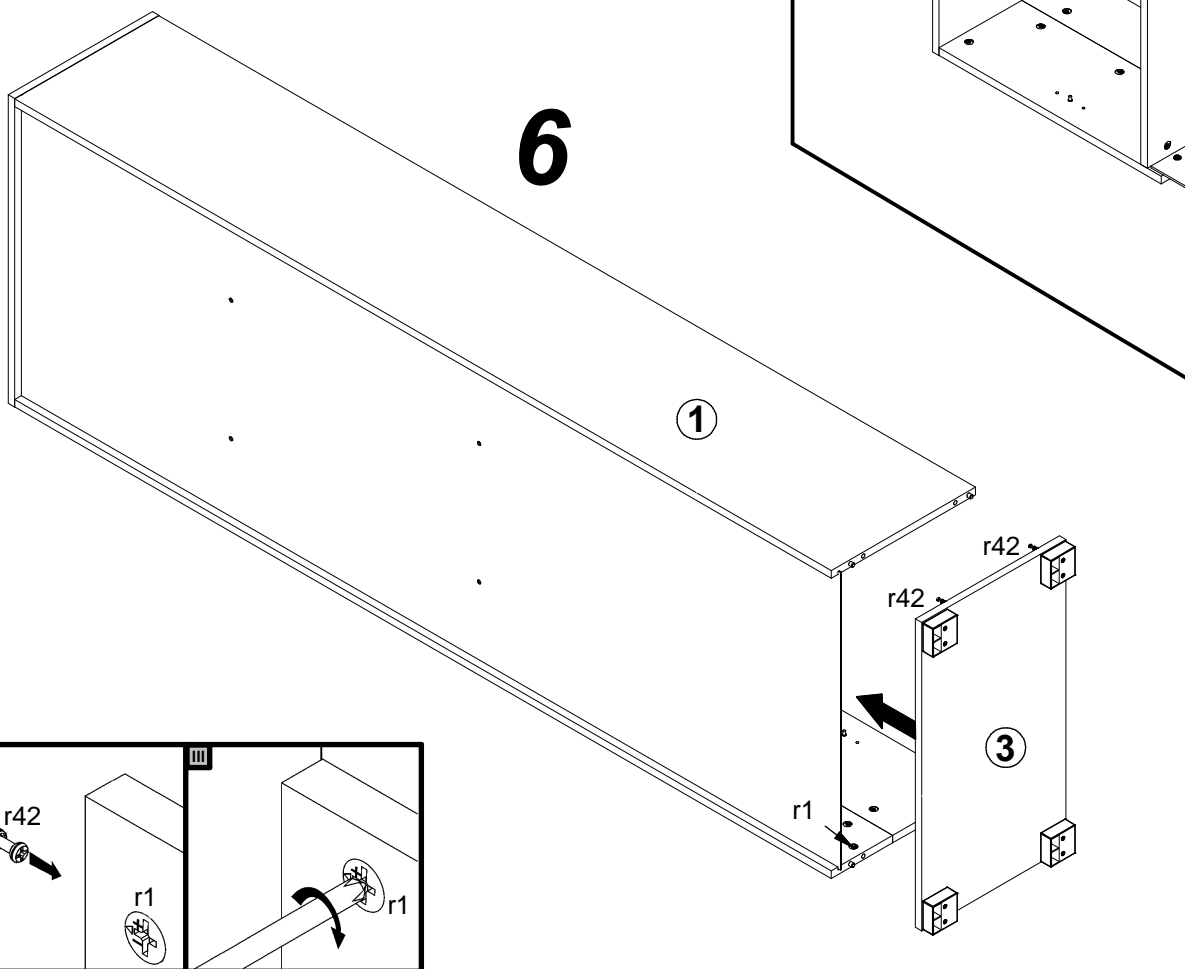

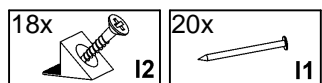

**AB**

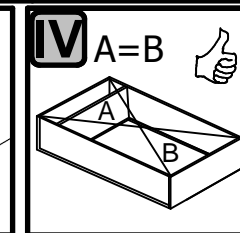
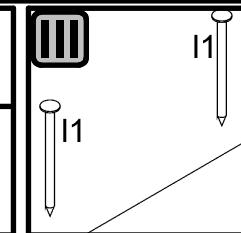
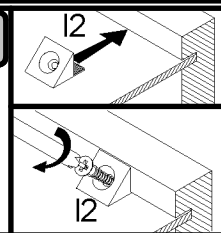
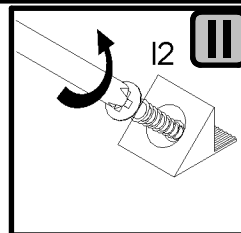
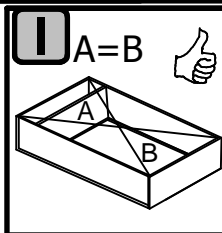

**7**

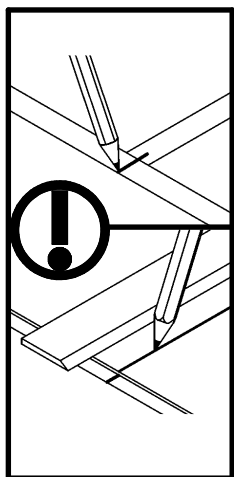
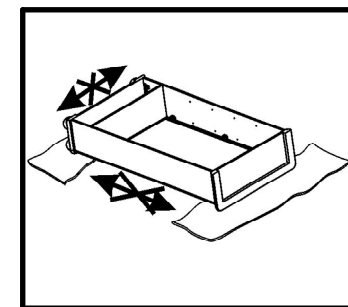
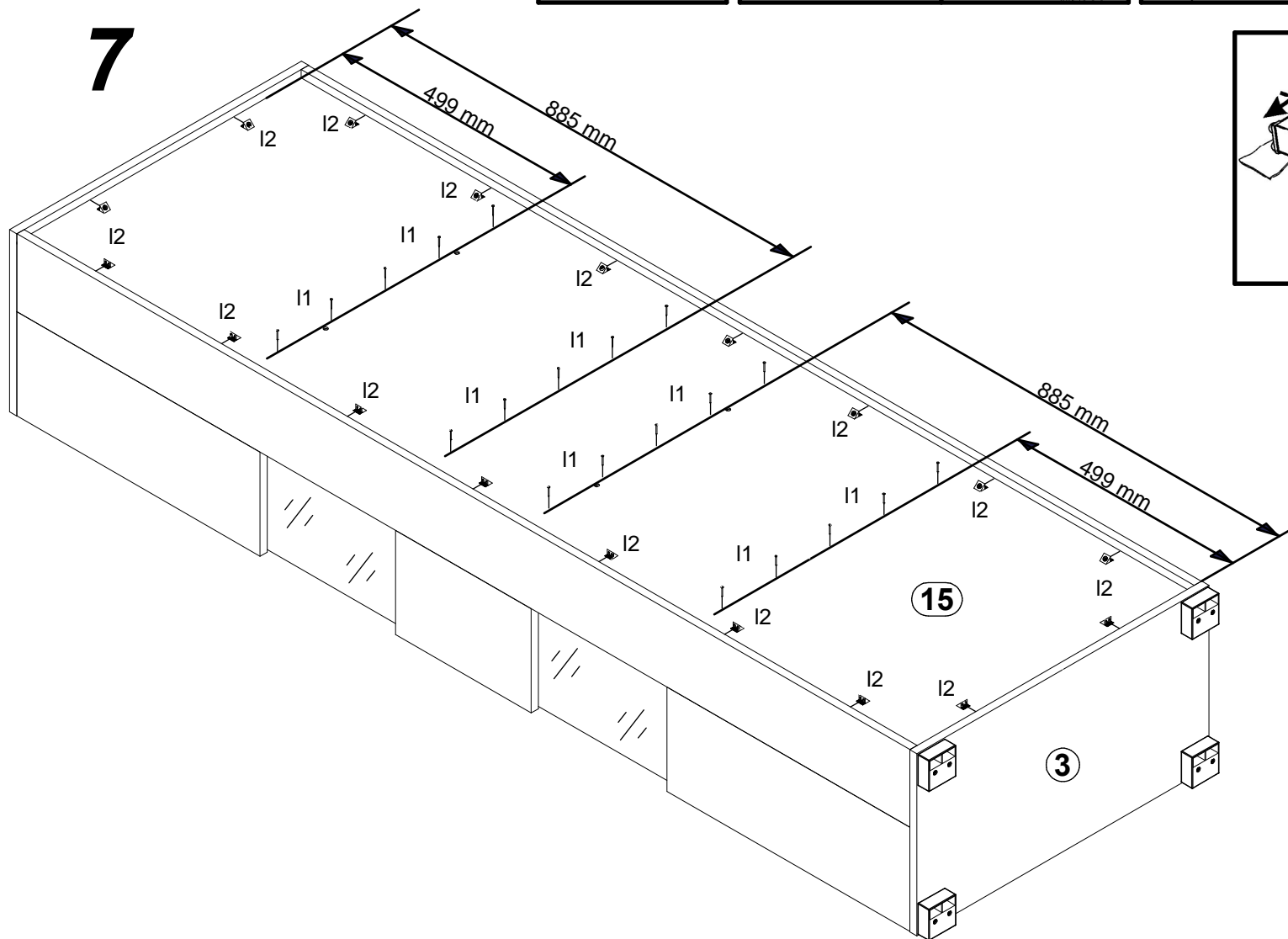

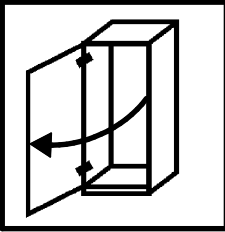

A



8

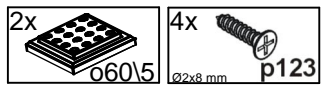
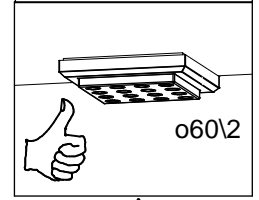
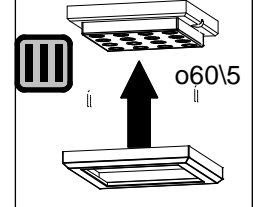
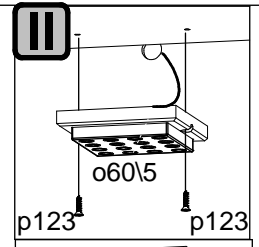
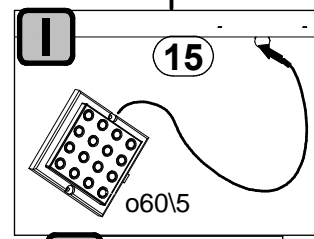
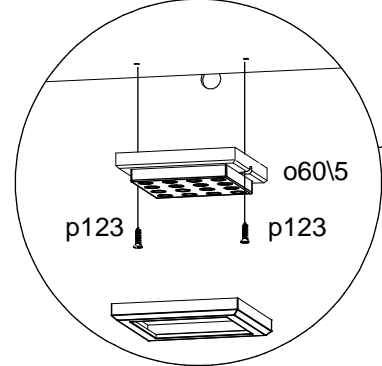
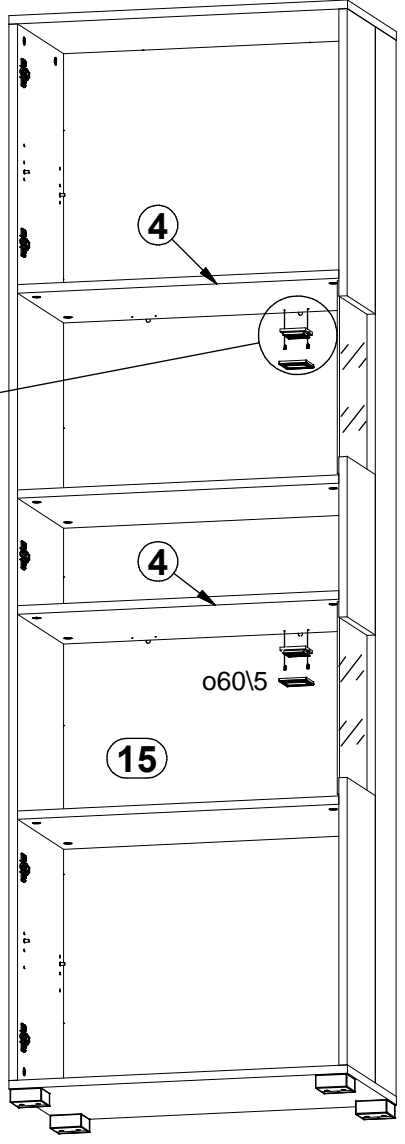

8



B

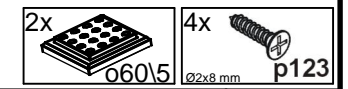
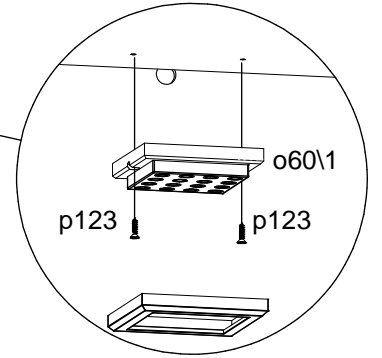
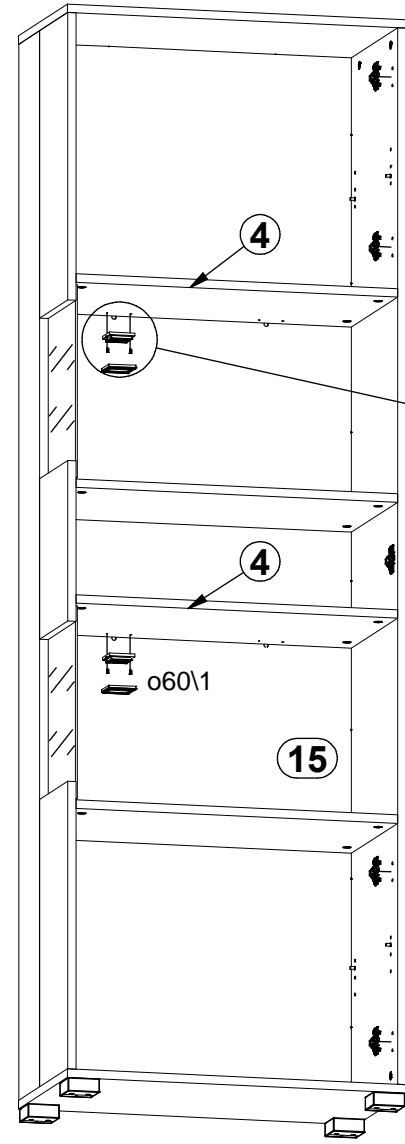
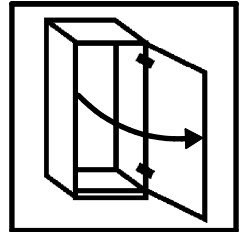

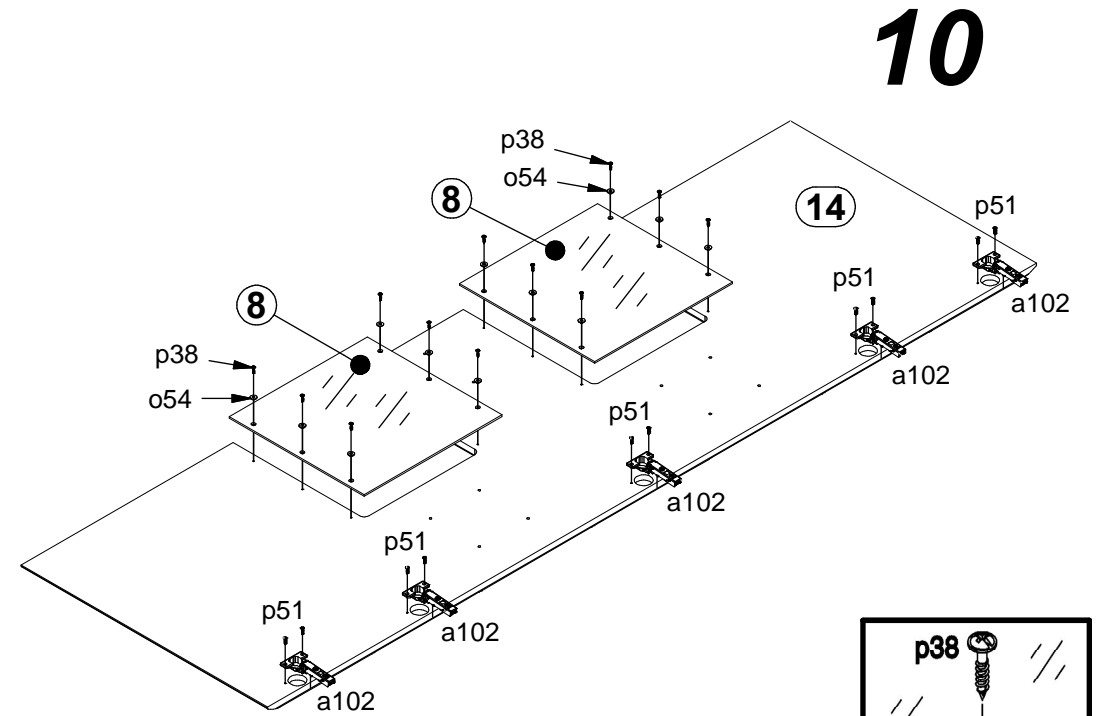
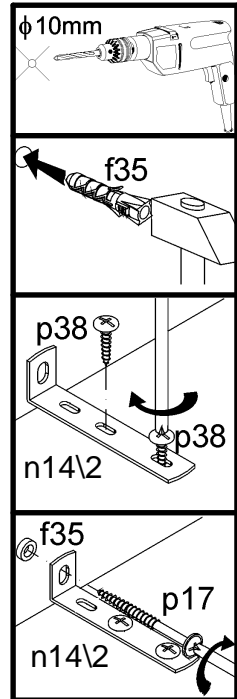
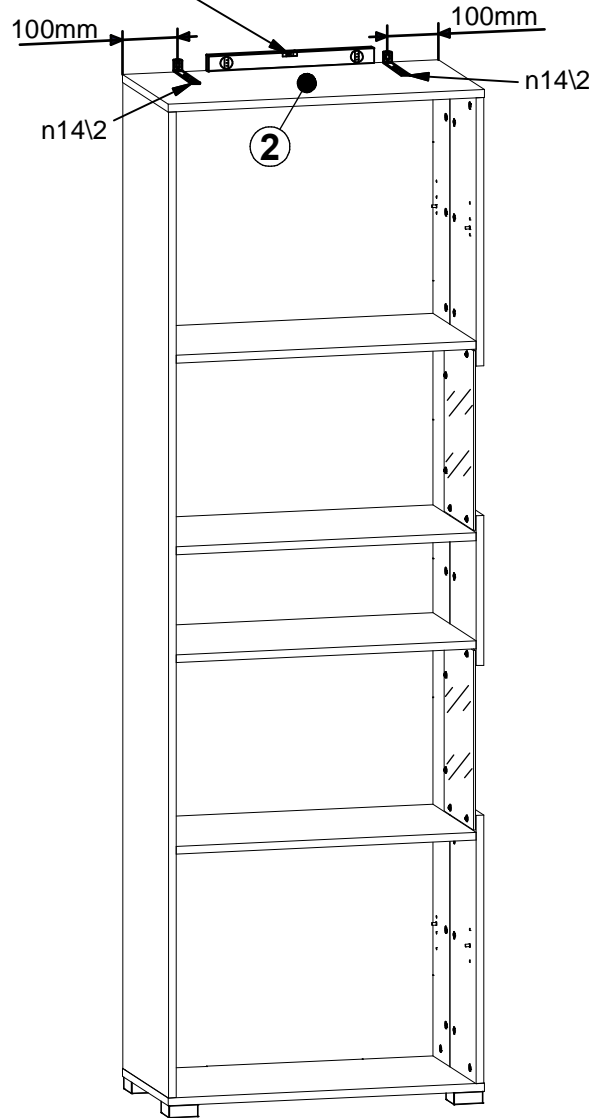
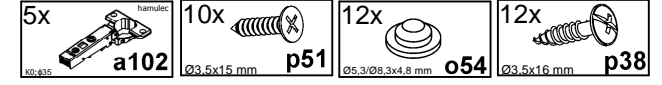
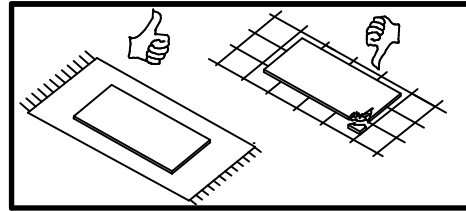
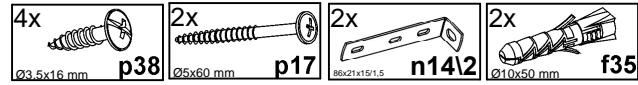
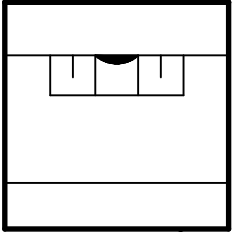

10

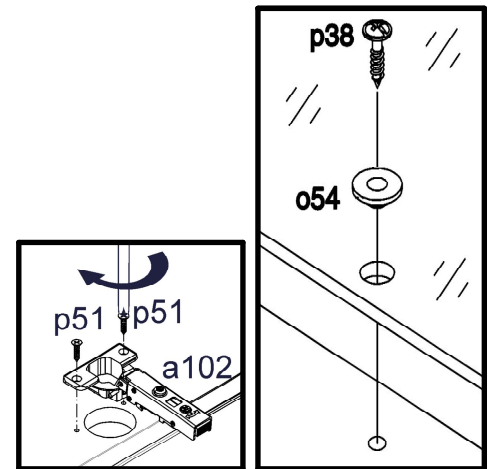

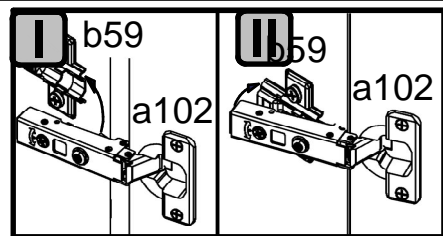

11

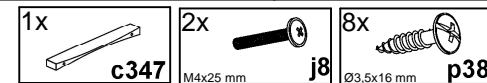
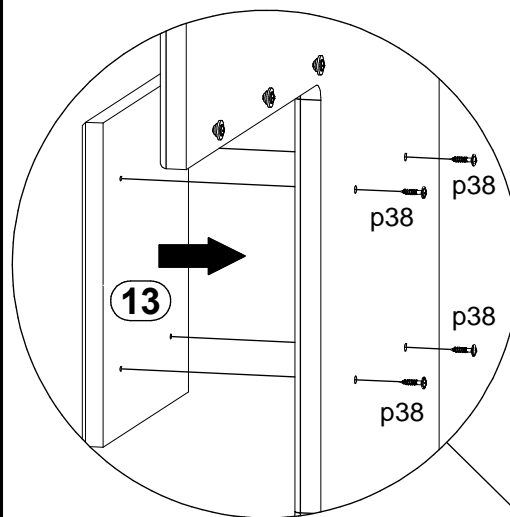
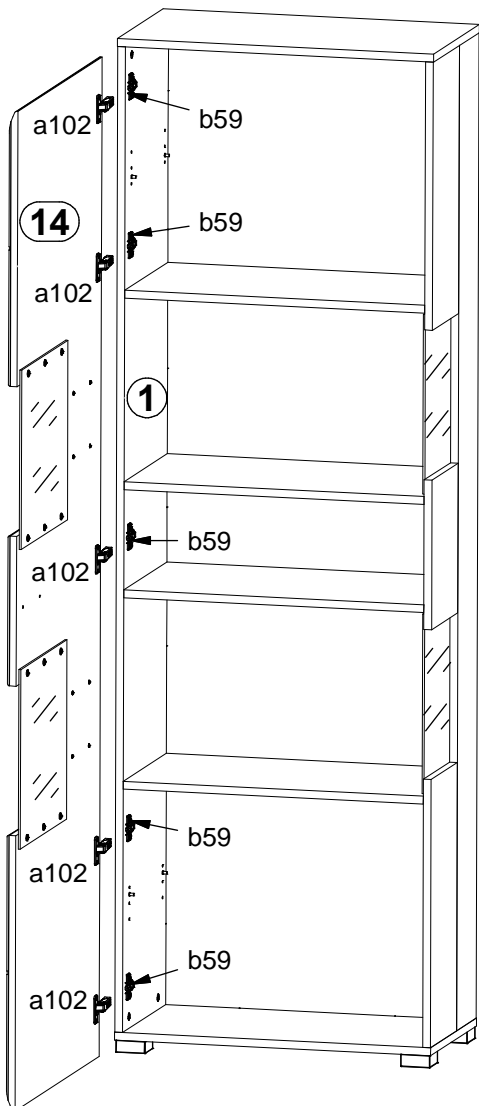

12

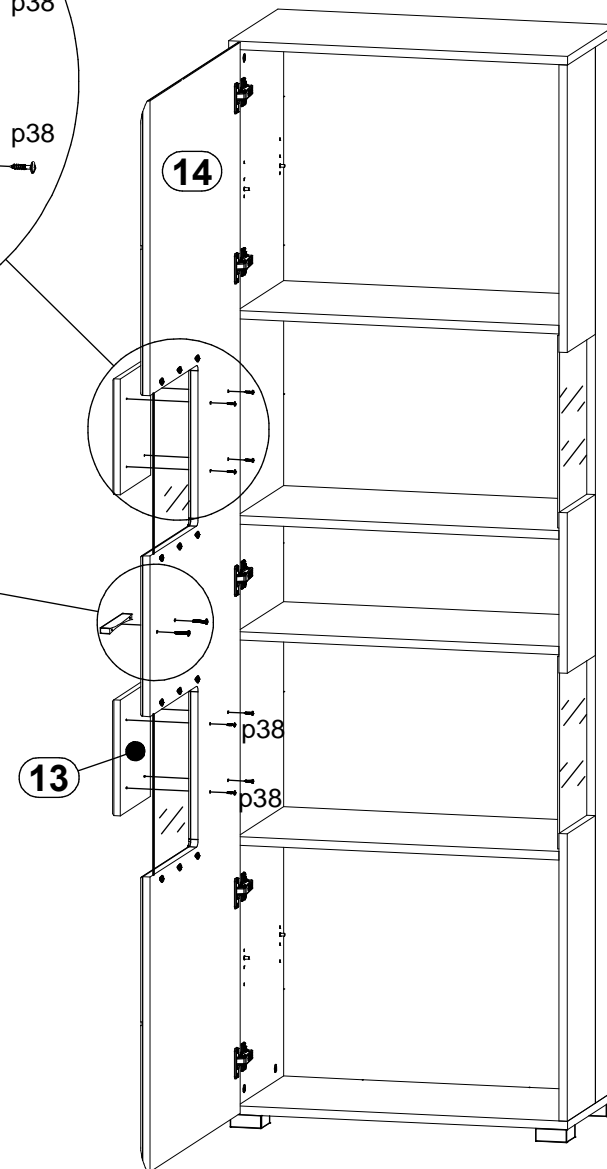
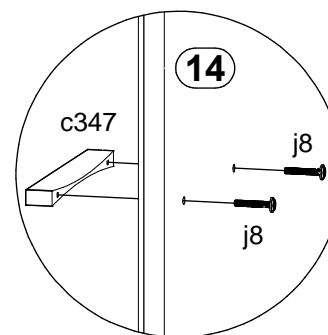



# 13

