

A**M164-PAN/16/10****30 30 CC 40**

2 / 7

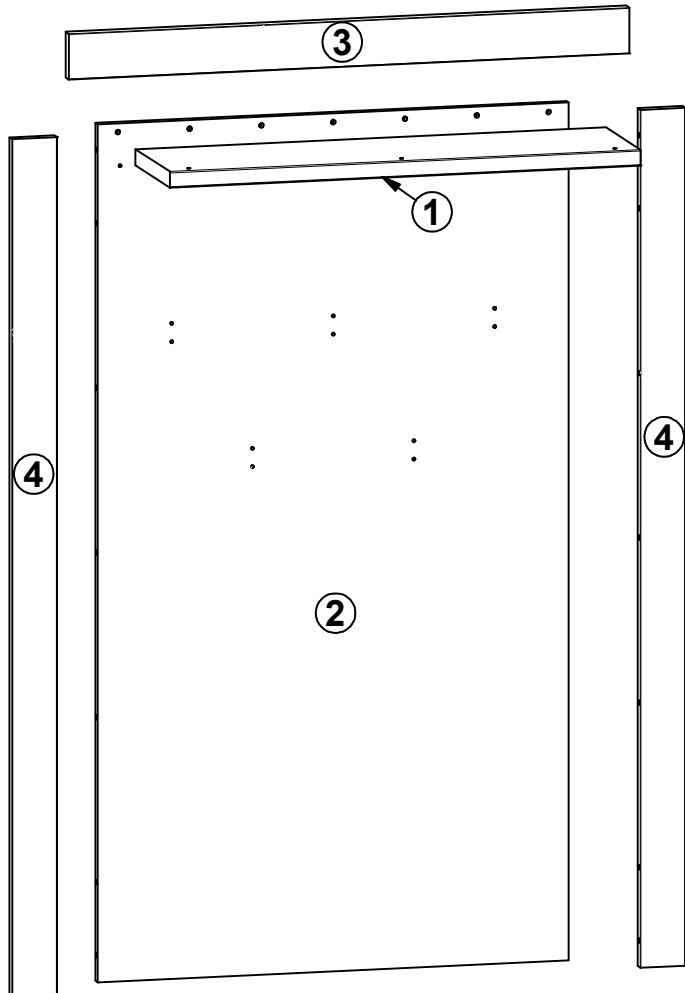

A	B	C (mm)		D
1	M143-317	839	230	2/2
2	M143-404	1500	840	1/2
3	M143-5515	1000	80	2/2
4	M143-5516	1500	80	1/2

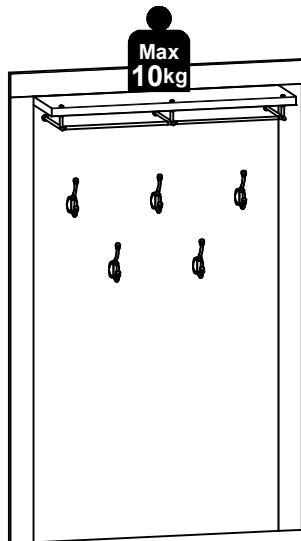
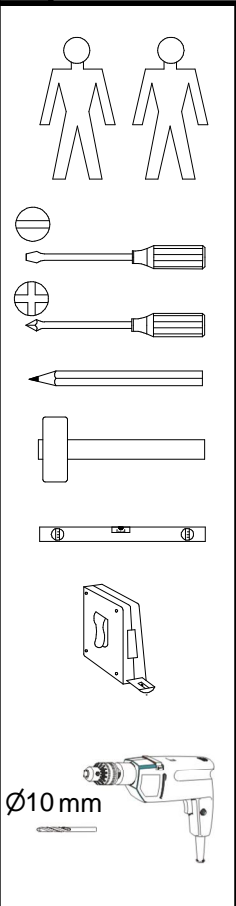
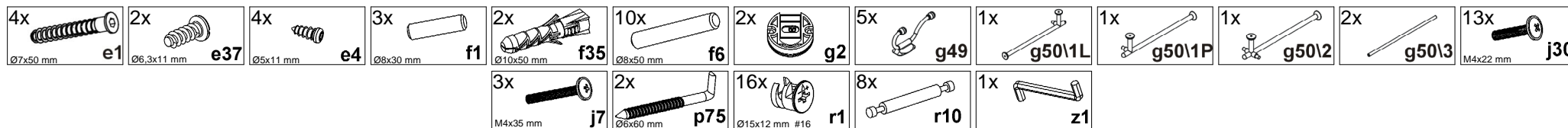
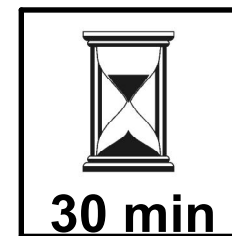

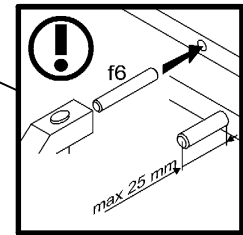
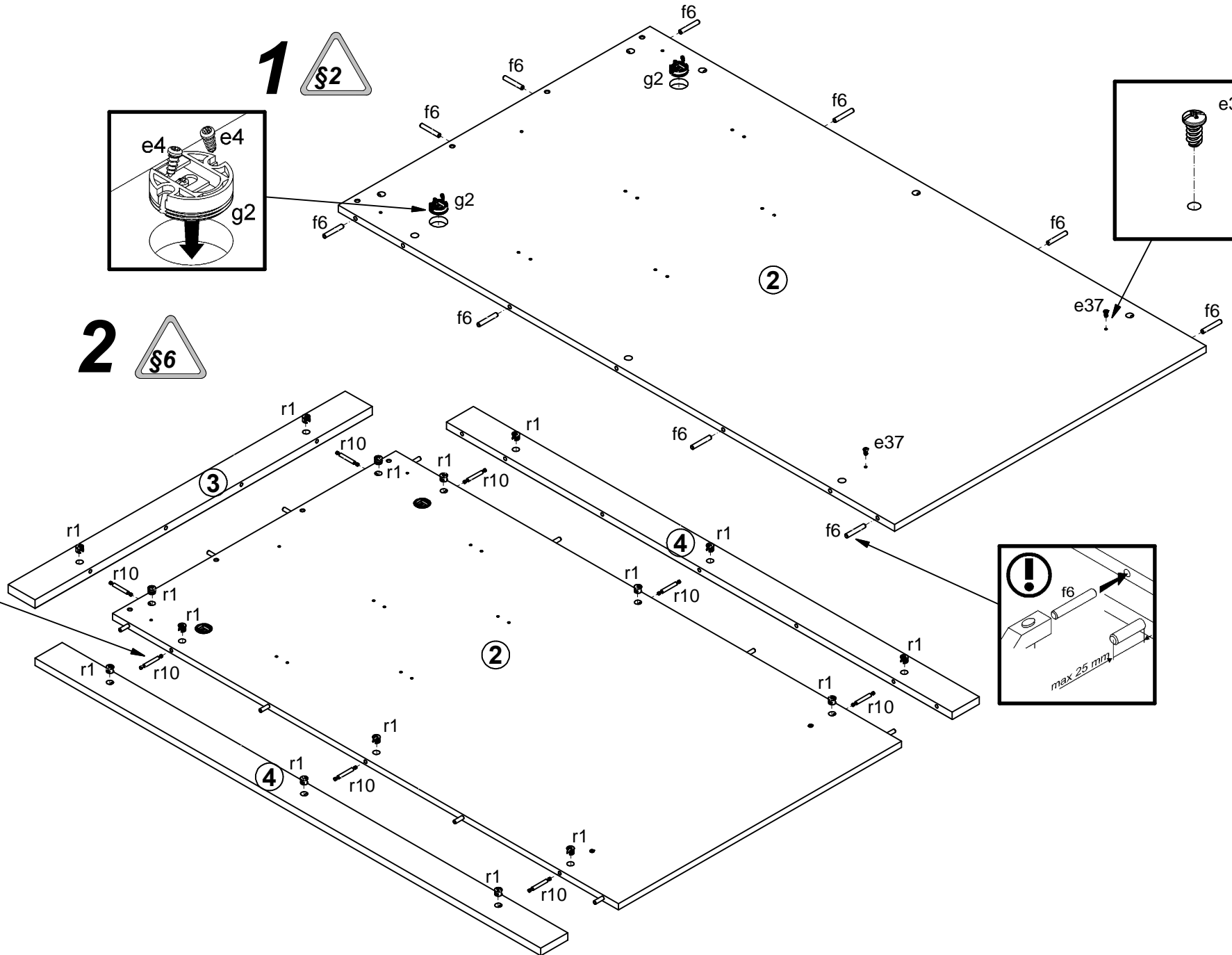
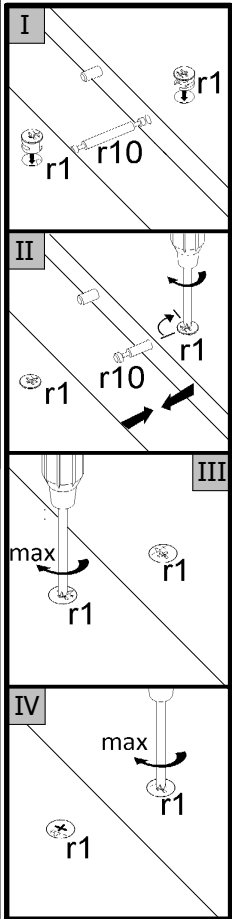
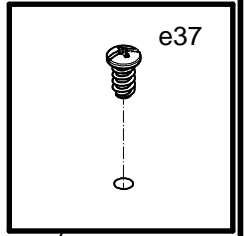
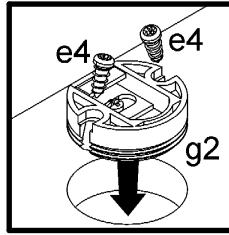

3

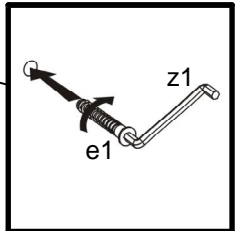
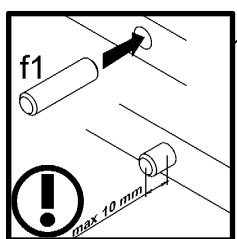
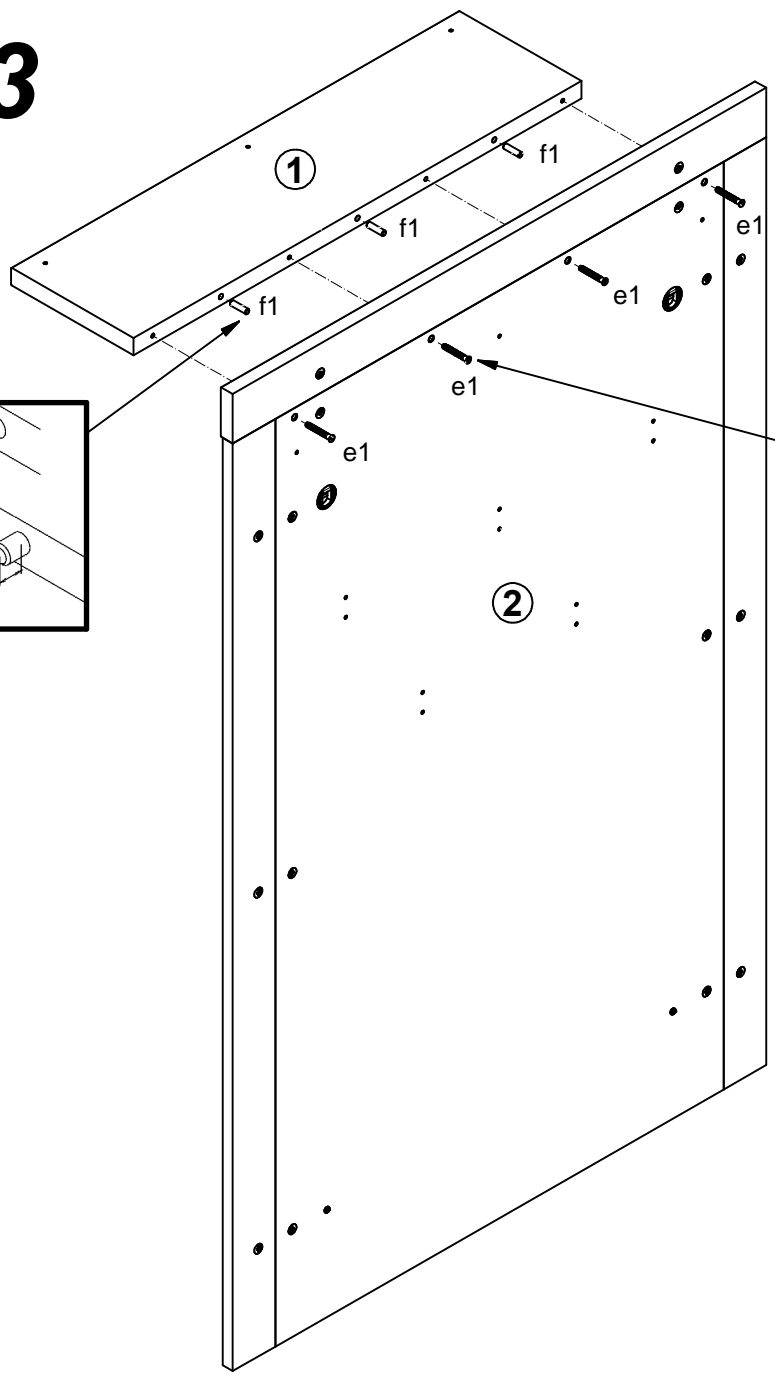

4

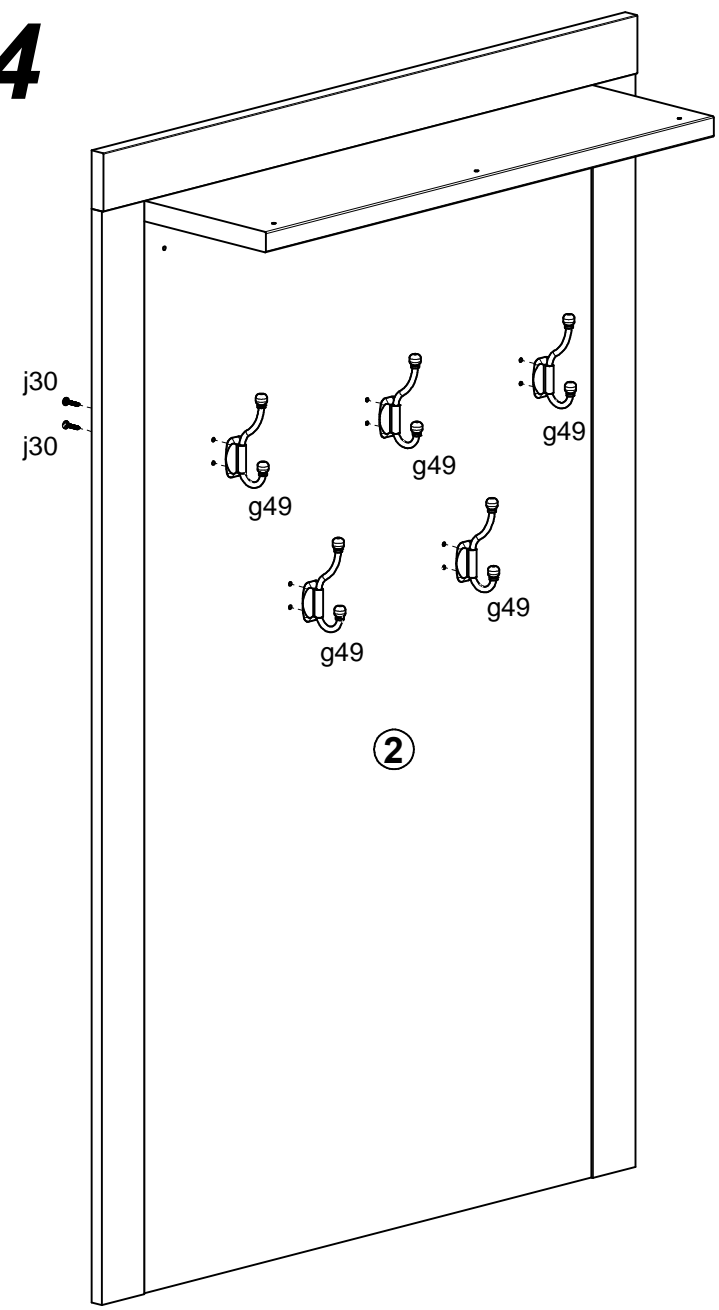

5

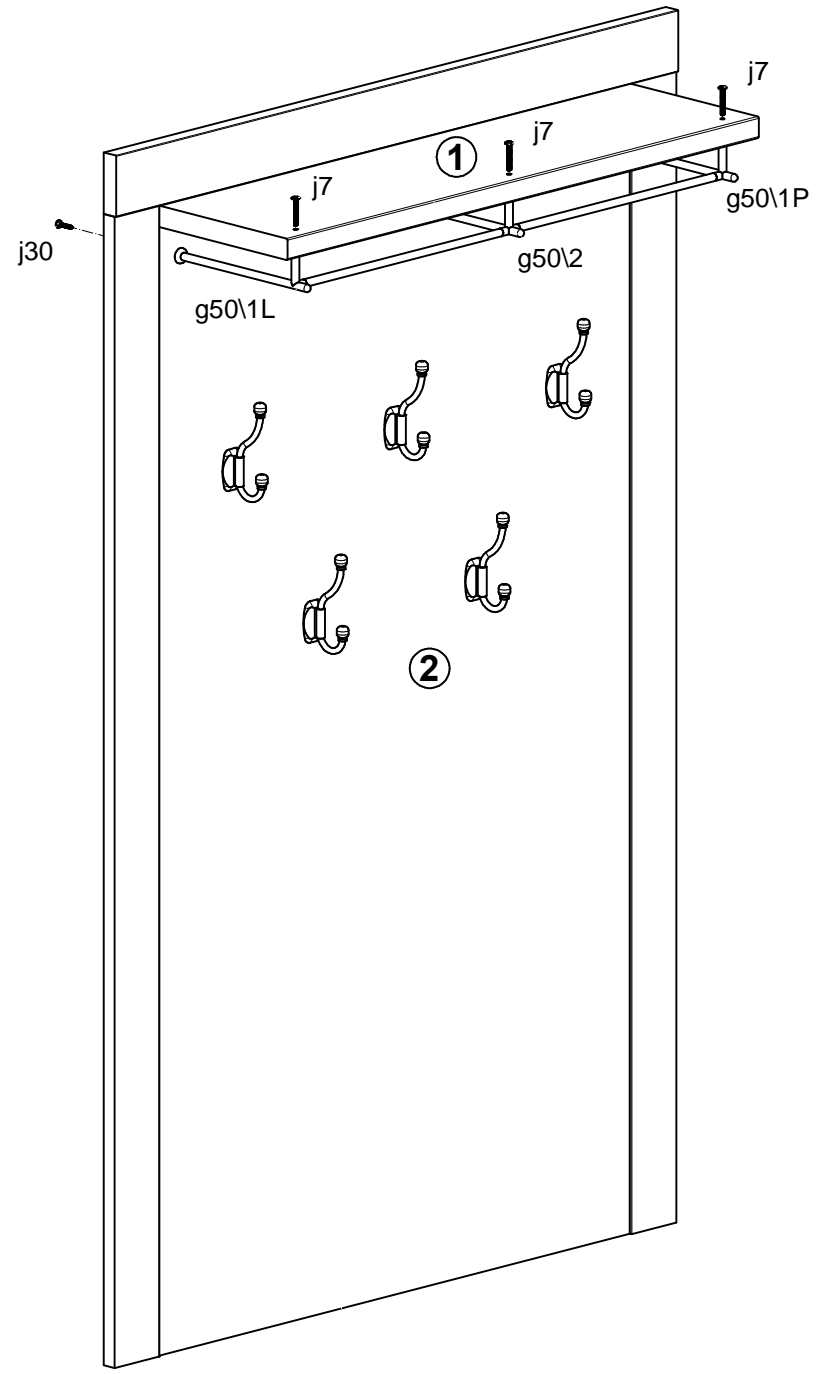
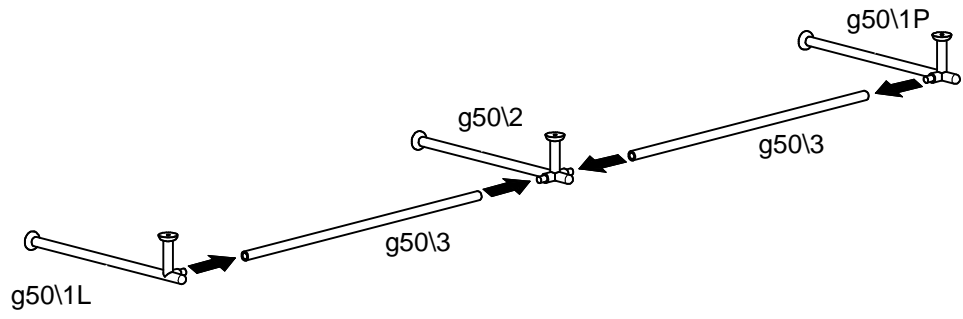

6

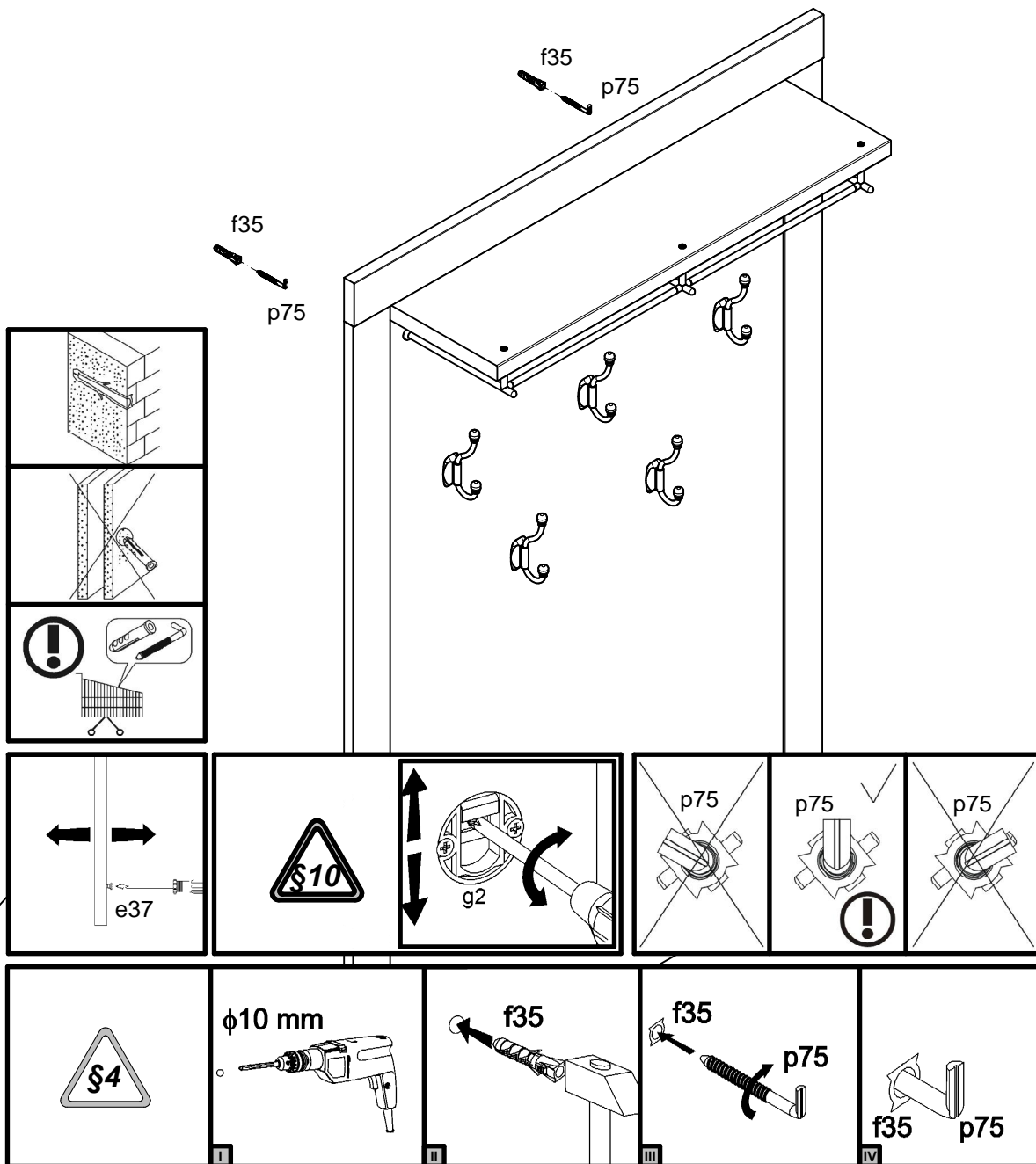
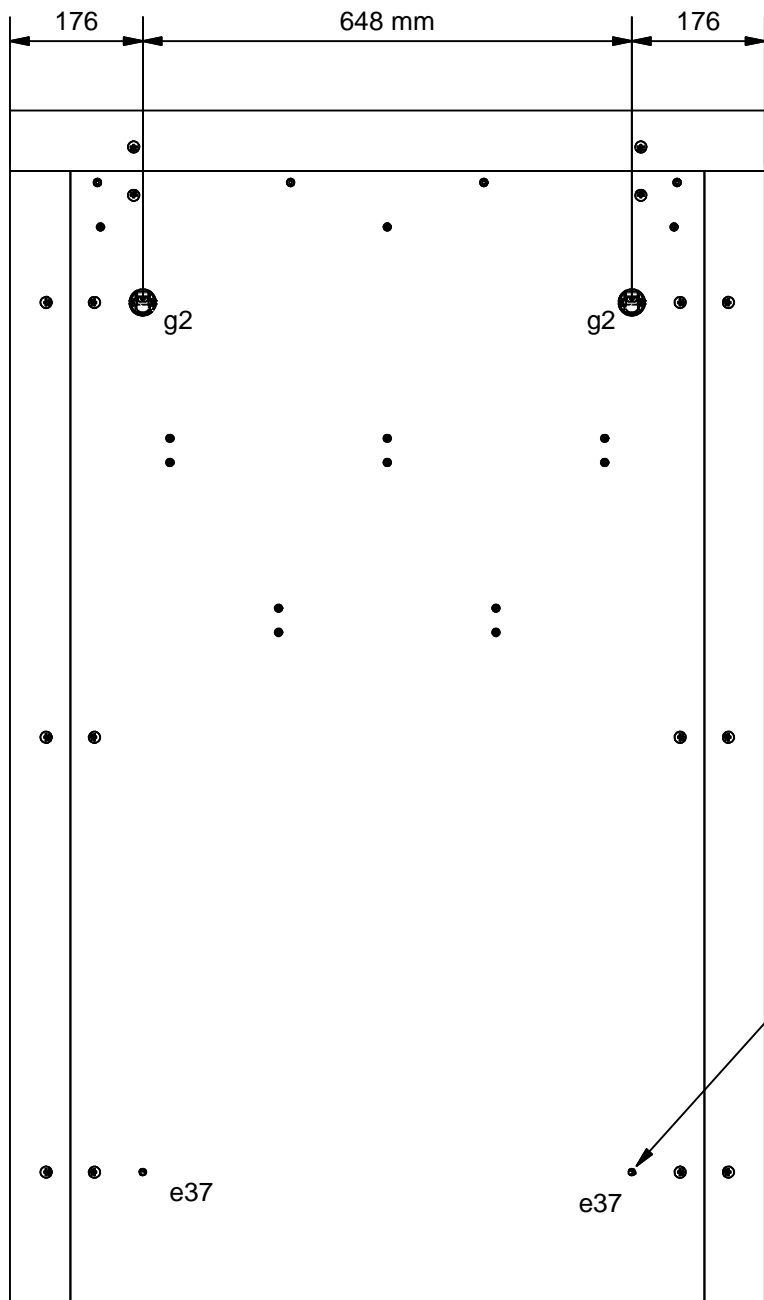

7

