

A	B	C (mm)		D
1	M196-0001	348	348	3/3
2	M196-0002A	1433	348,	3/3
3	M196-0003A	1433	294	3/3
4	M196-1003	1809	382	2/3
5	M196-1004	1809	382	2/3
6	M196-1005	1809,	362	3/3
7	M196-2003	1093	400	1/3
8	M196-2004	1073	387	1/3
9	M196-3001	724	340	2/3
10	M196-3002	723,	340	2/3
11	M196-3003	724	362	1/3
12	M196-3004	300	340	2/3
13	M196-3005	300	362	1/3
14	M196-3006	299	340	1/3
15	M196-5501	347	33	3/3
16	M196-5502A	1432	33	3/3
17	M196-9001	1819	315	2/3
18	M196-9301	1819,	735	2/3
19	S248-0009	163	294	1/3
20	S248-4003	300	60	1/3
21	WSK3-503	300	120	1/3
22	WSK3-504	300	120	1/3
23	WSP-9090	265	298	1/3
24	WTR-5026	255	120	1/3

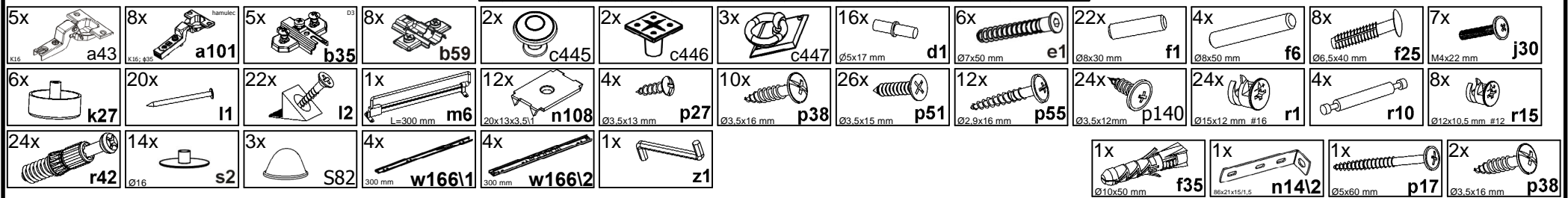

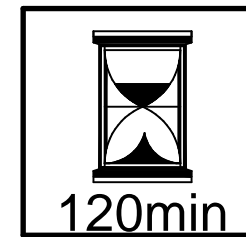

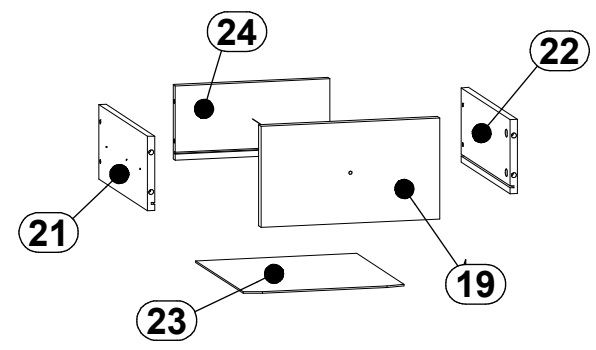
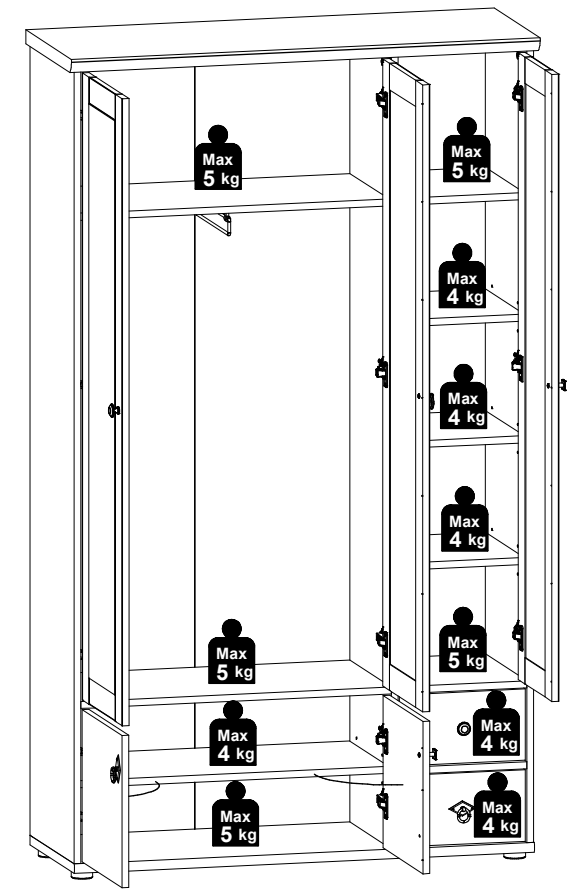
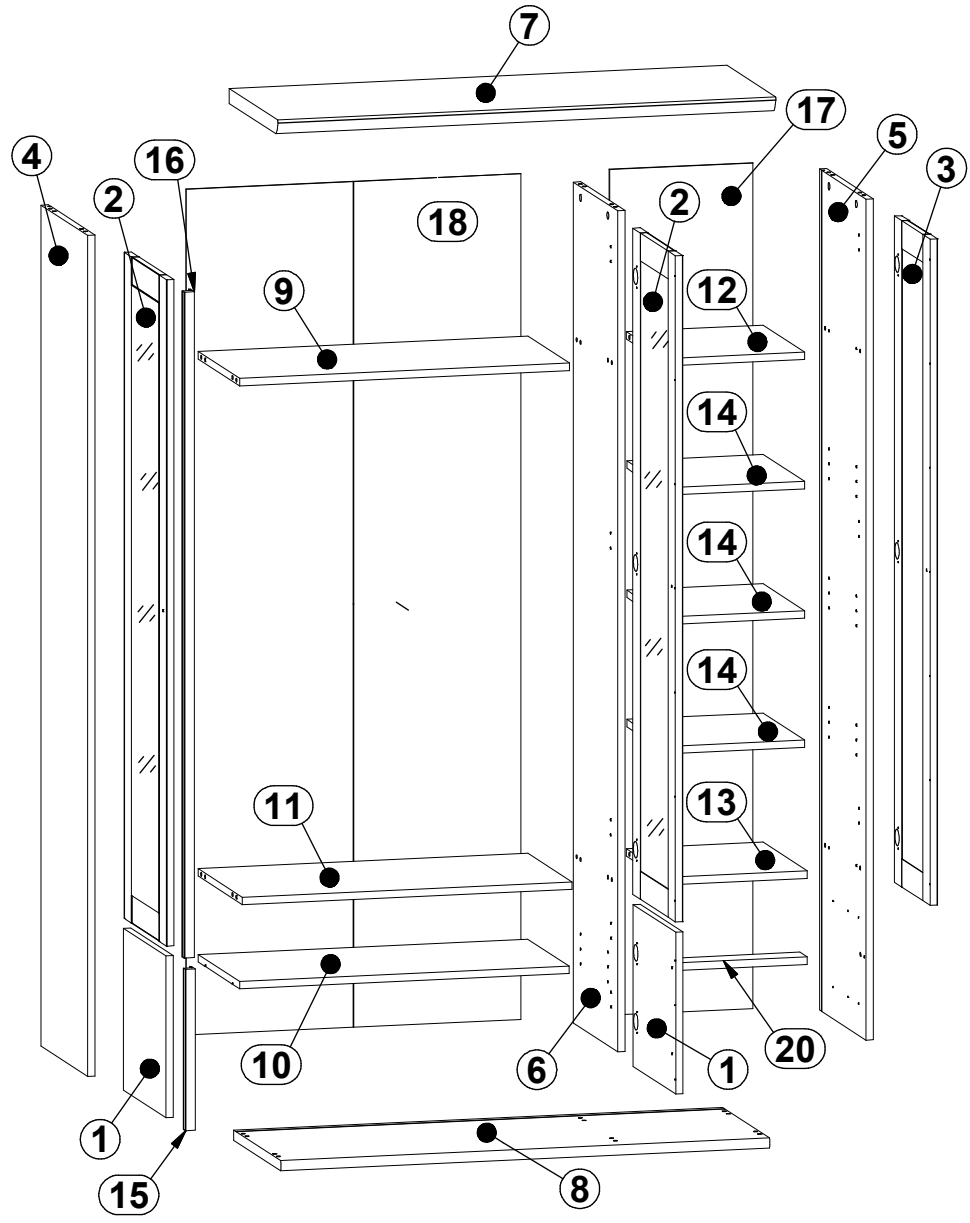
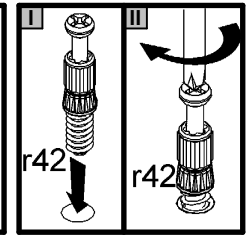
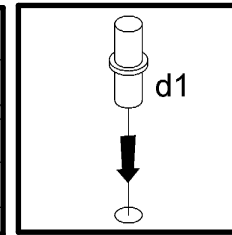
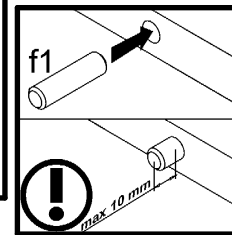
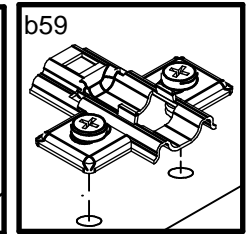
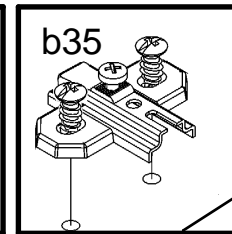
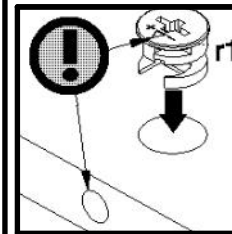
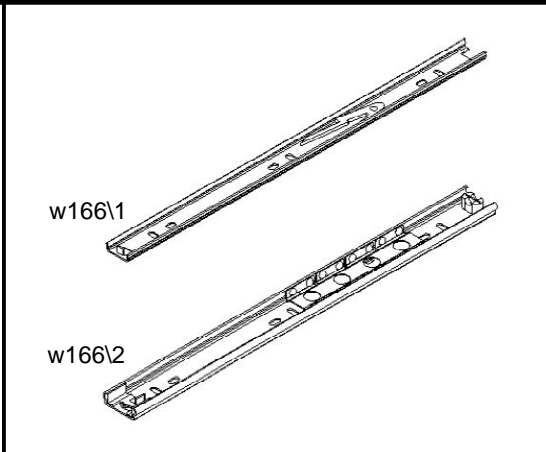
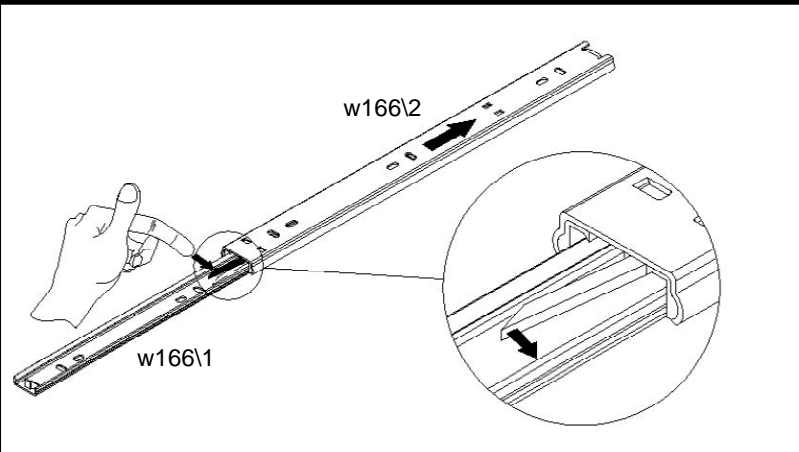

**1**

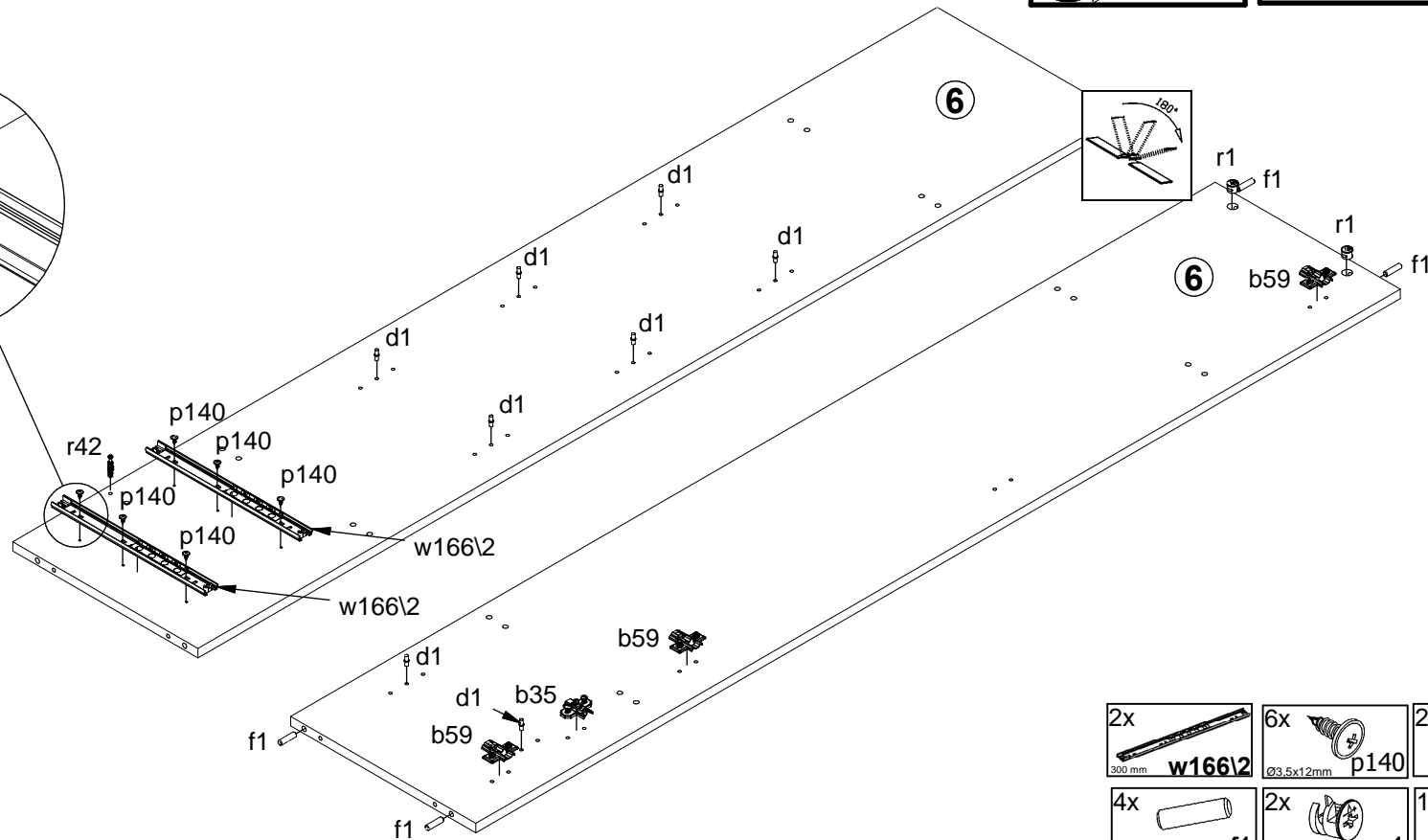
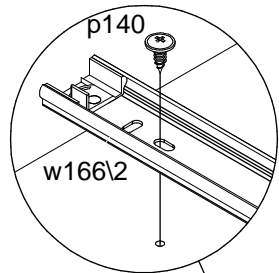

2x 300 mm <b>w166\2</b>	6x Ø3,5x12mm <b>p140</b>	2x <b>b35</b>	3x <b>b59</b>
4x Ø6x30 mm <b>f1</b>	2x Ø15x12 mm #16 <b>r1</b>	1x <b>r42</b>	8x Ø5x17 mm <b>d1</b>

2x 300 mm <b>w166\2</b>	6x Ø3.5x12mm <b>p140</b>	5x <b>r42</b>	2x <b>b59</b>
4x Ø8x30 mm <b>f1</b>	2x Ø15x12 mm #16 <b>r1</b>	6x Ø5x17 mm <b>d1</b>	

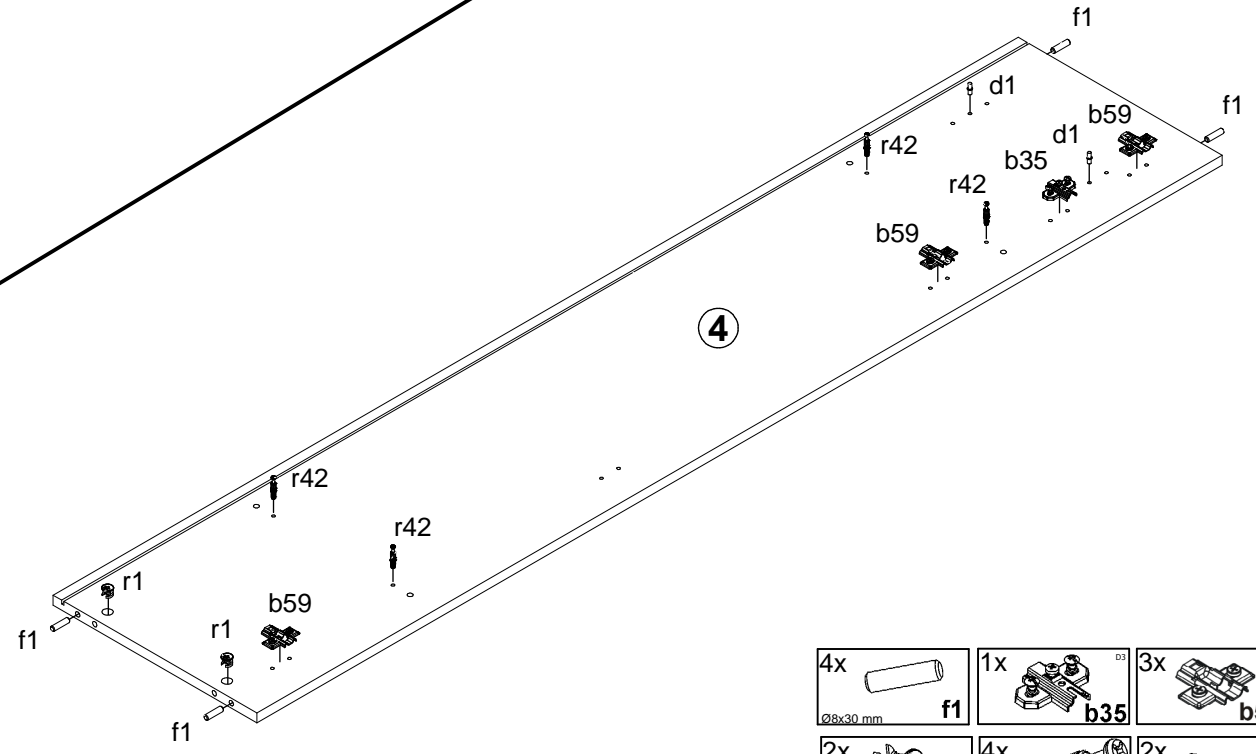
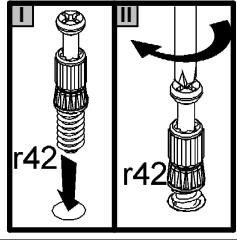
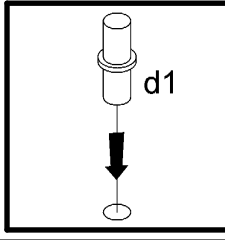
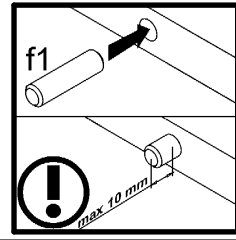
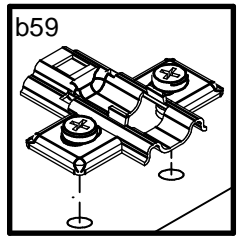
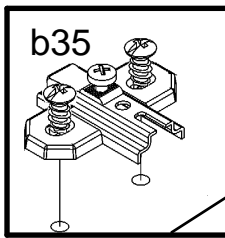
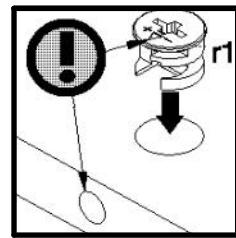
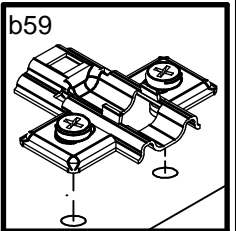
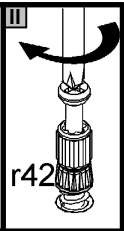
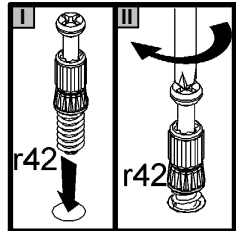
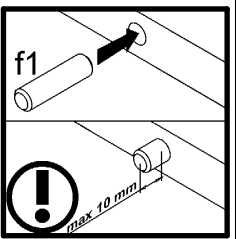
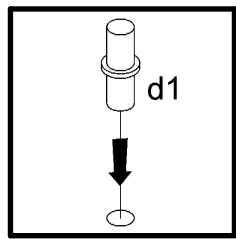
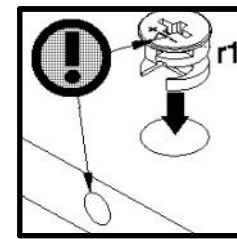
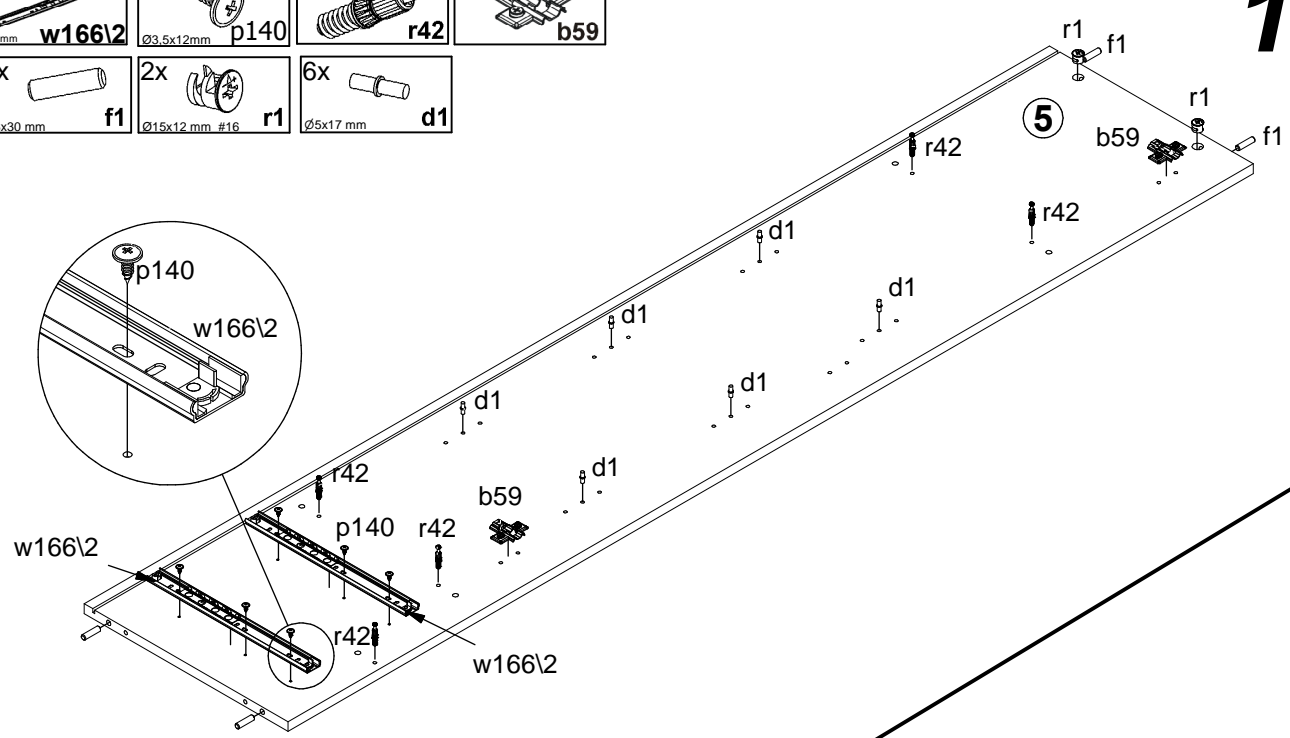
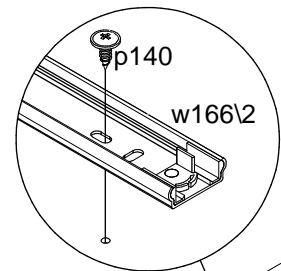

4x Ø8x30 mm <b>f1</b>	1x <b>b35</b>	3x <b>b59</b>
-----------------------------	------------------	------------------

2x Ø15x12 mm #16 <b>r1</b>	4x <b>r42</b>	2x Ø5x17 mm <b>d1</b>
----------------------------------	------------------	-----------------------------

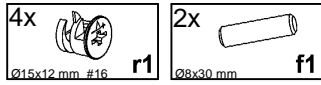
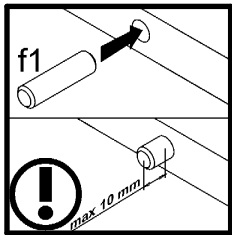

1

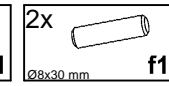
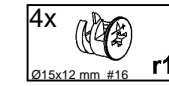
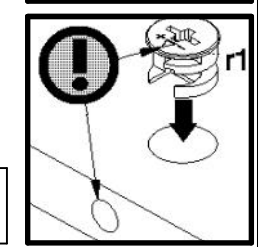
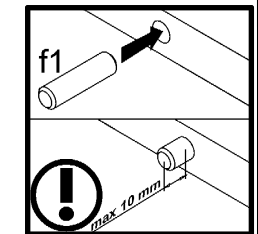
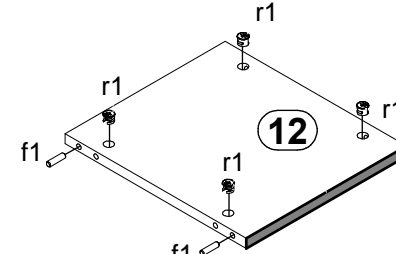
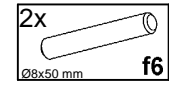
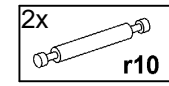
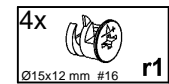
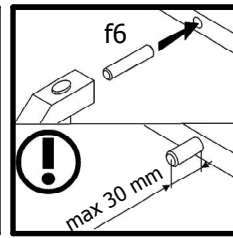
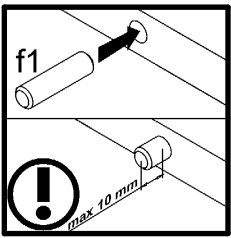
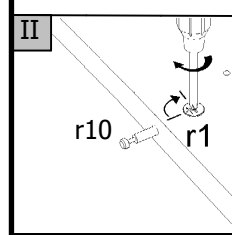
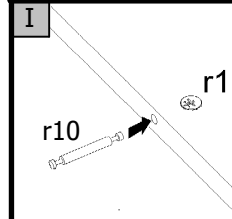
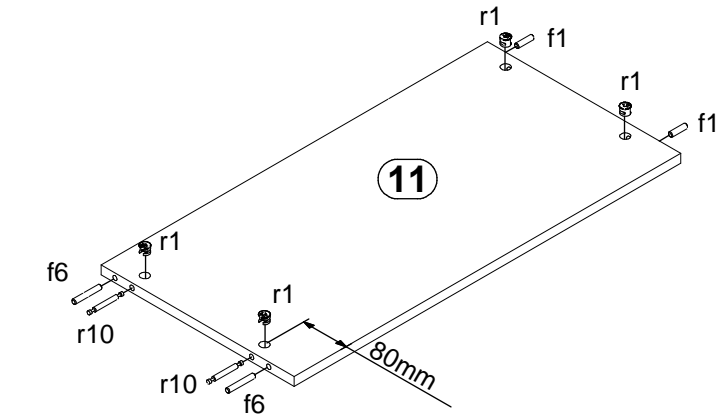
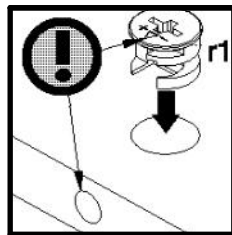
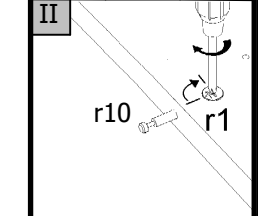
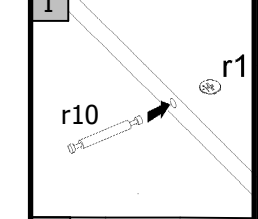
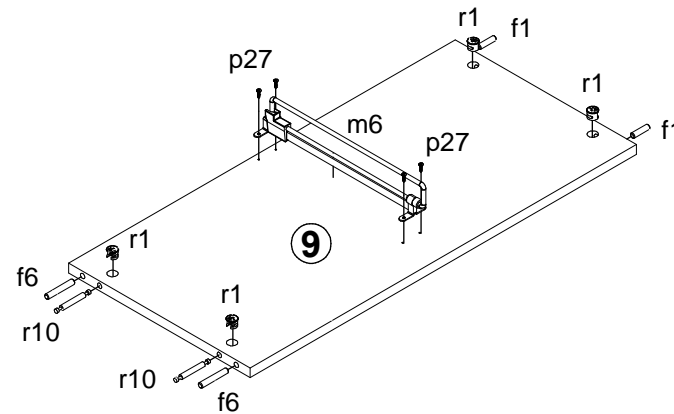
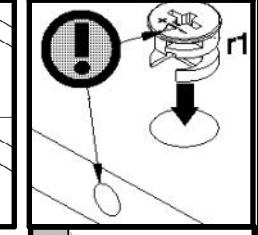
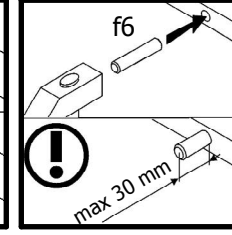
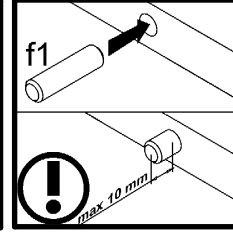
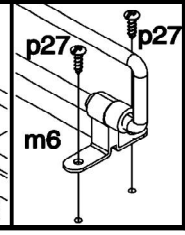
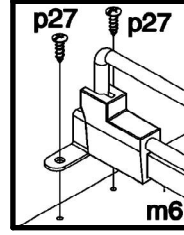
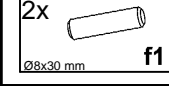
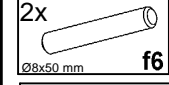
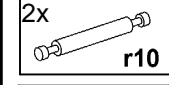
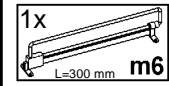
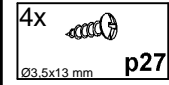
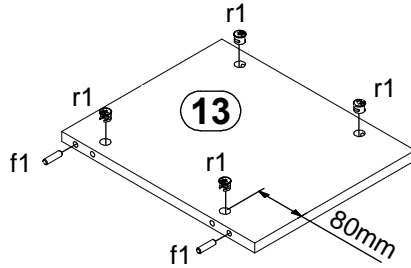
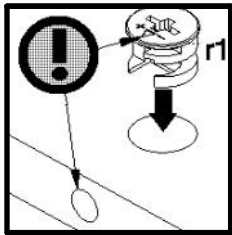

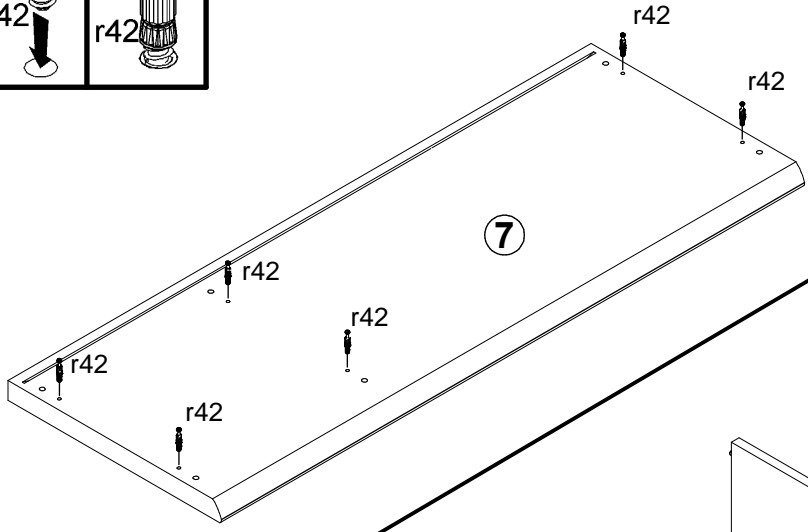
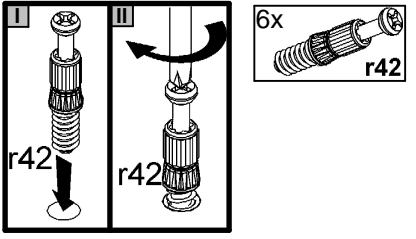

1

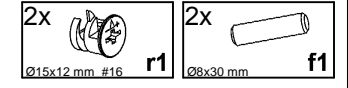
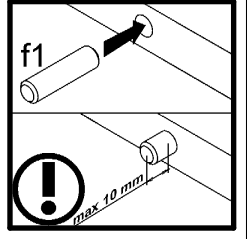
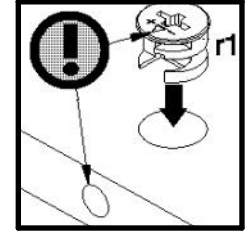
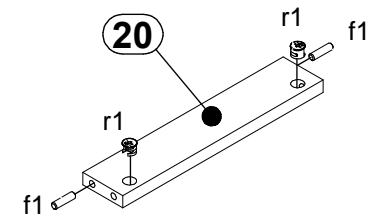

2

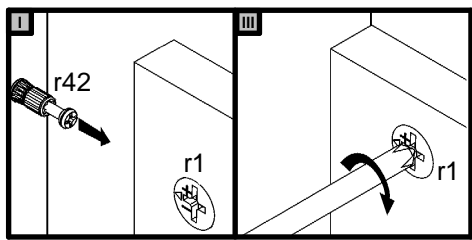
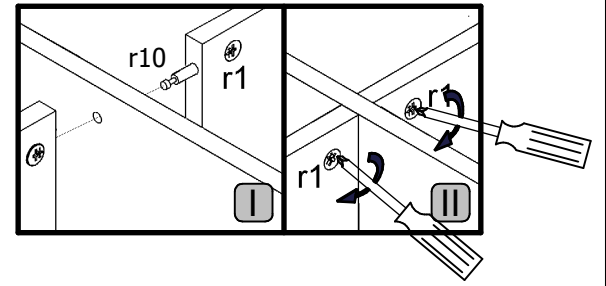
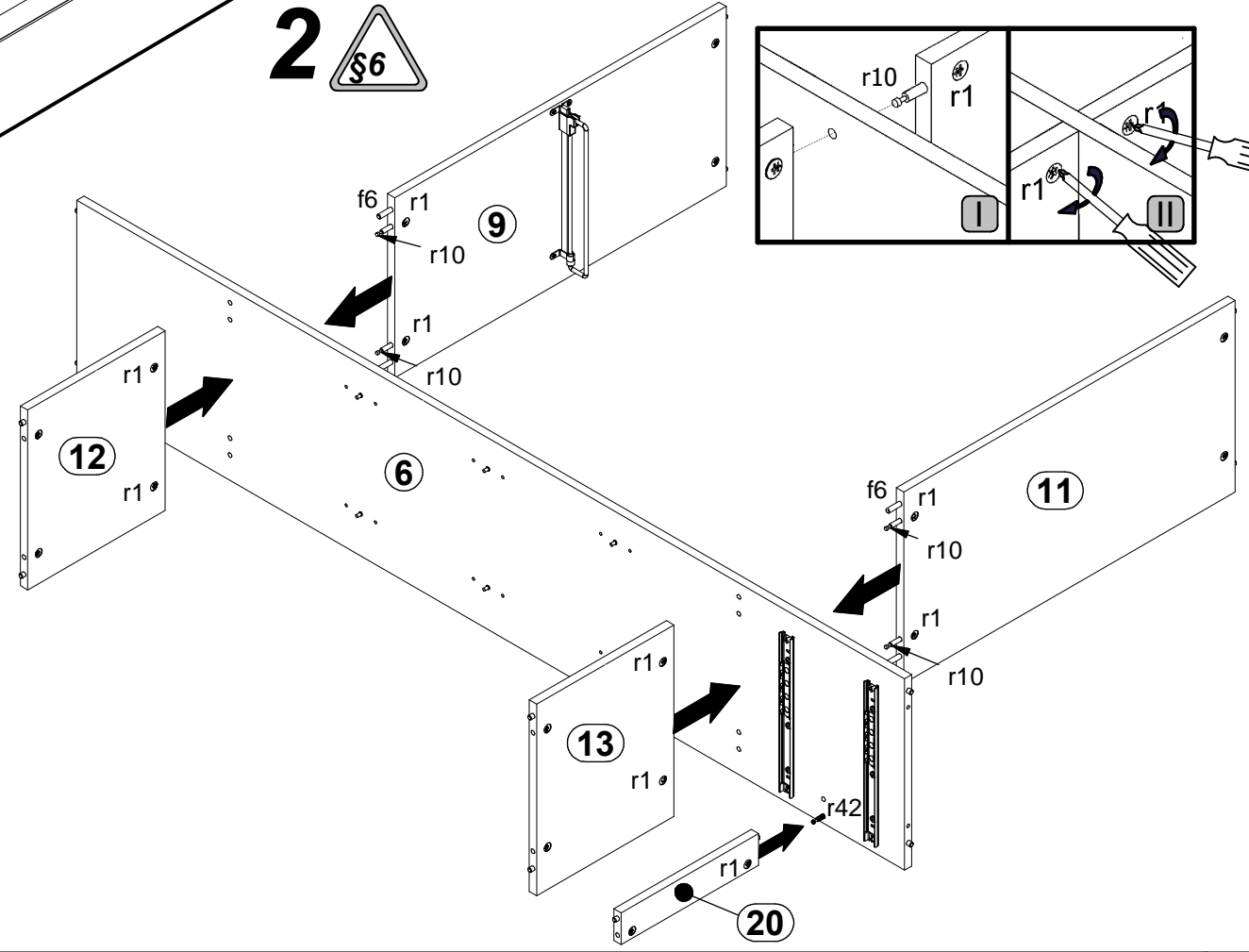

# 3

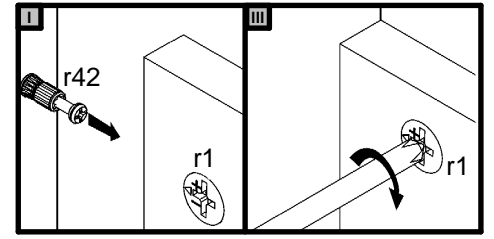
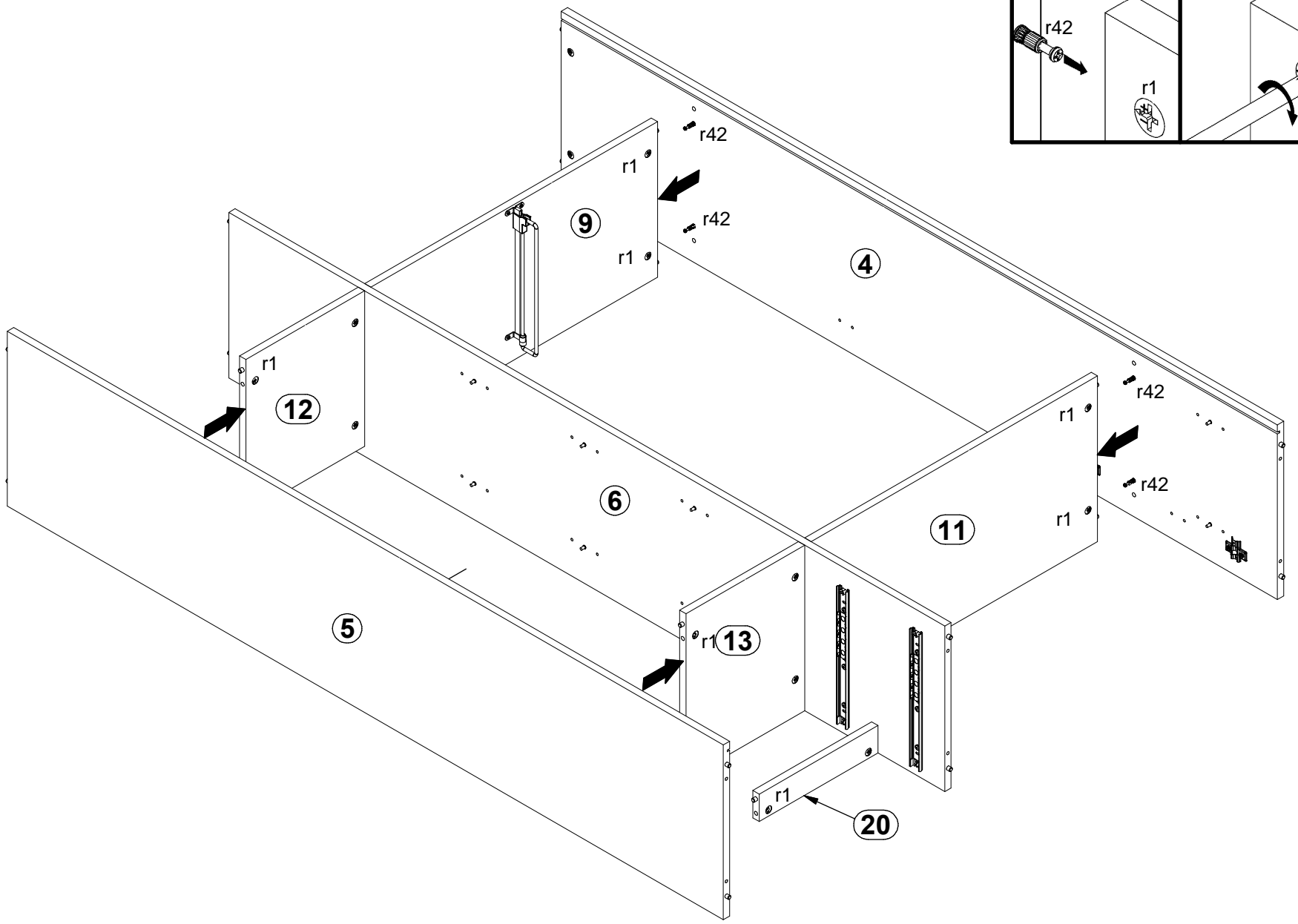



4

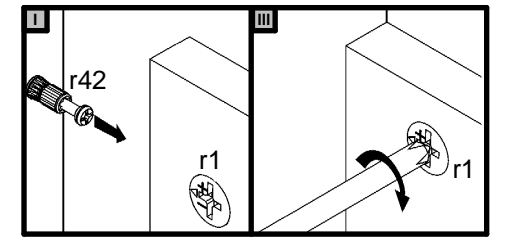
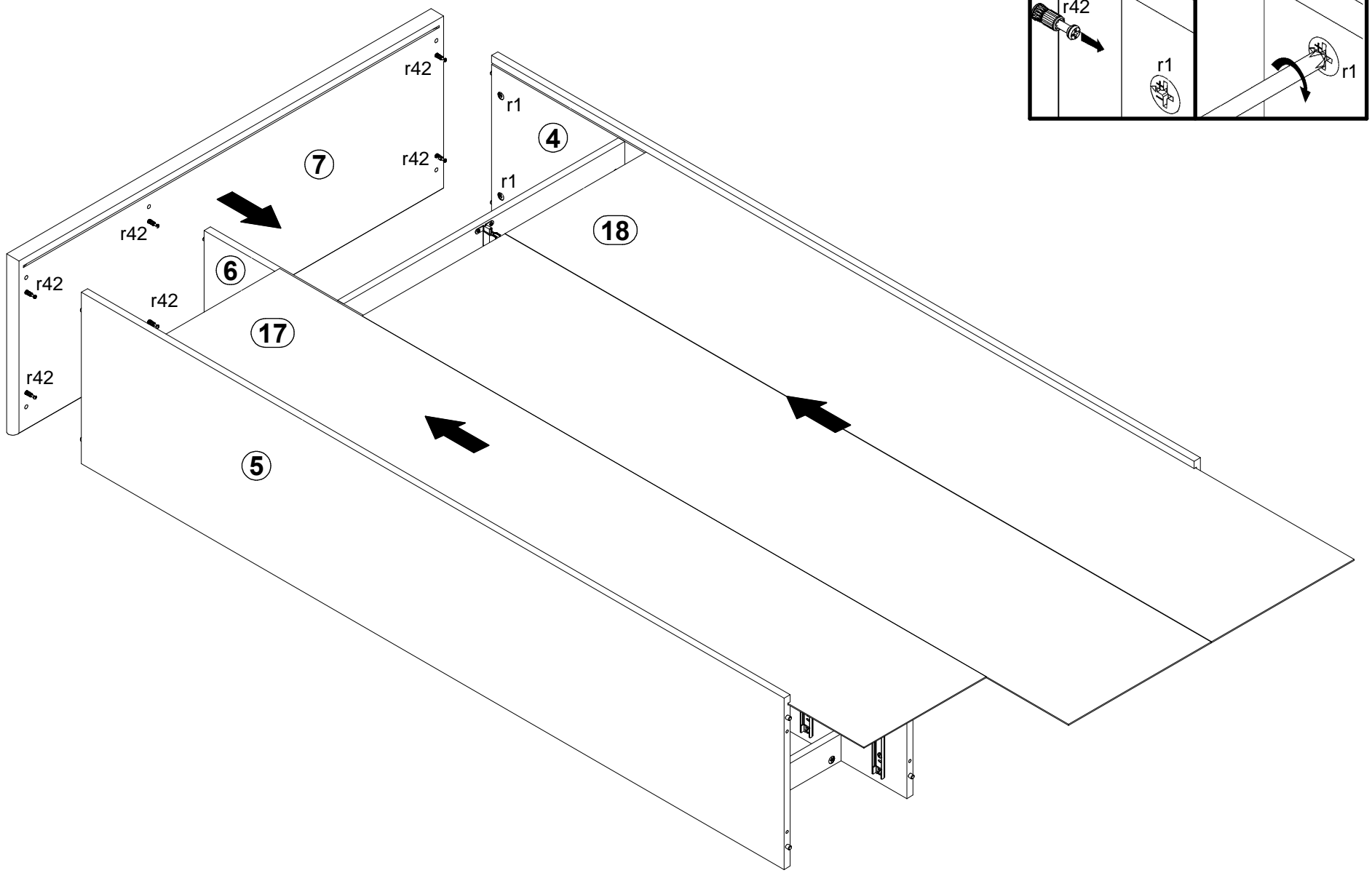

5

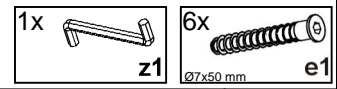
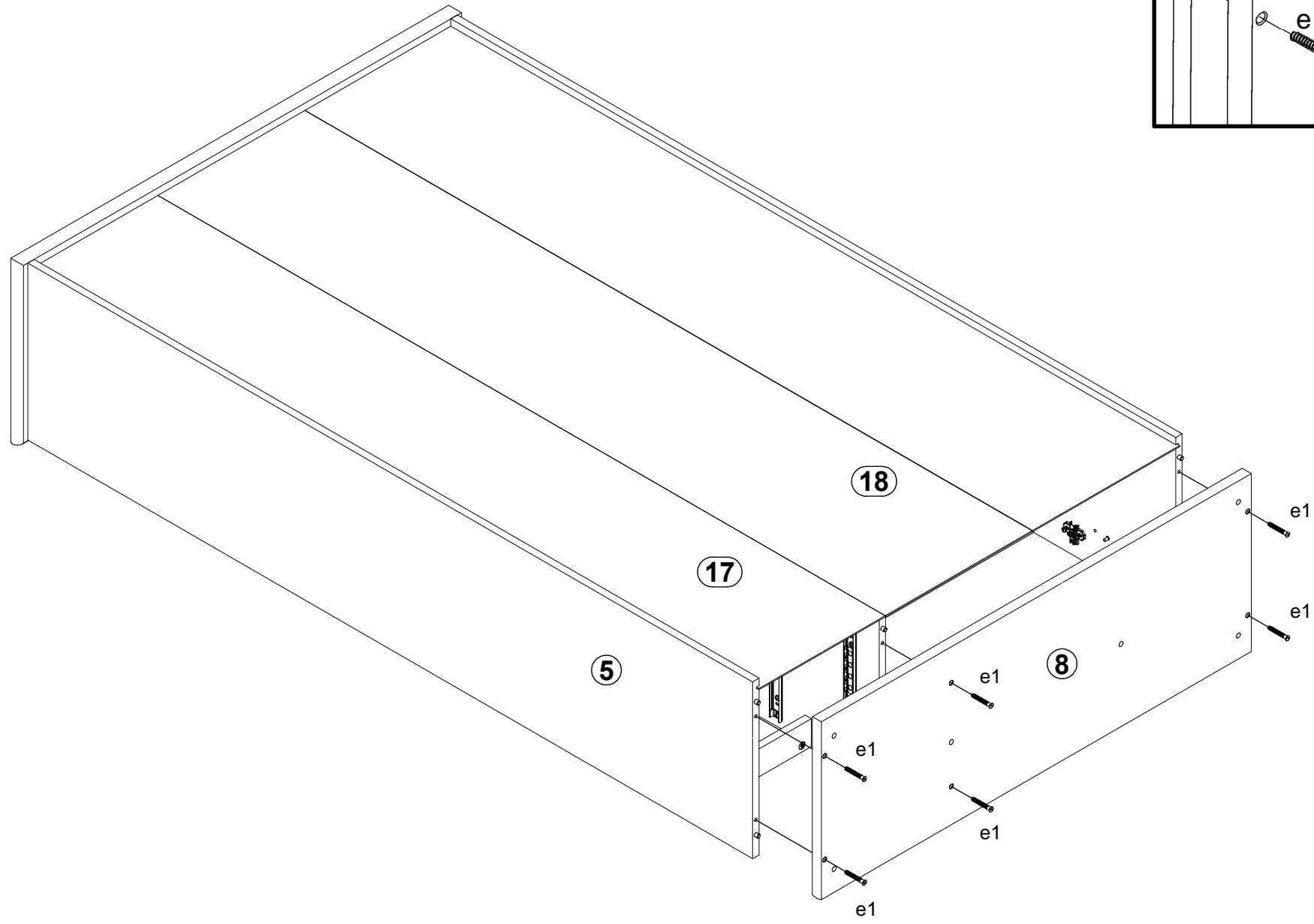
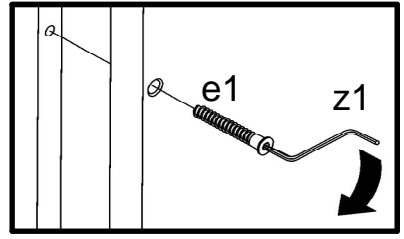

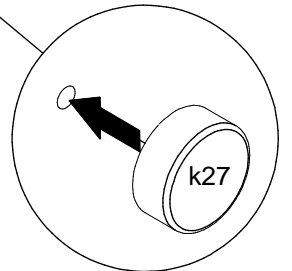
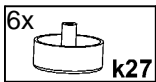
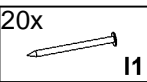
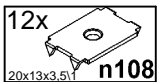
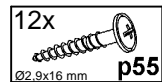
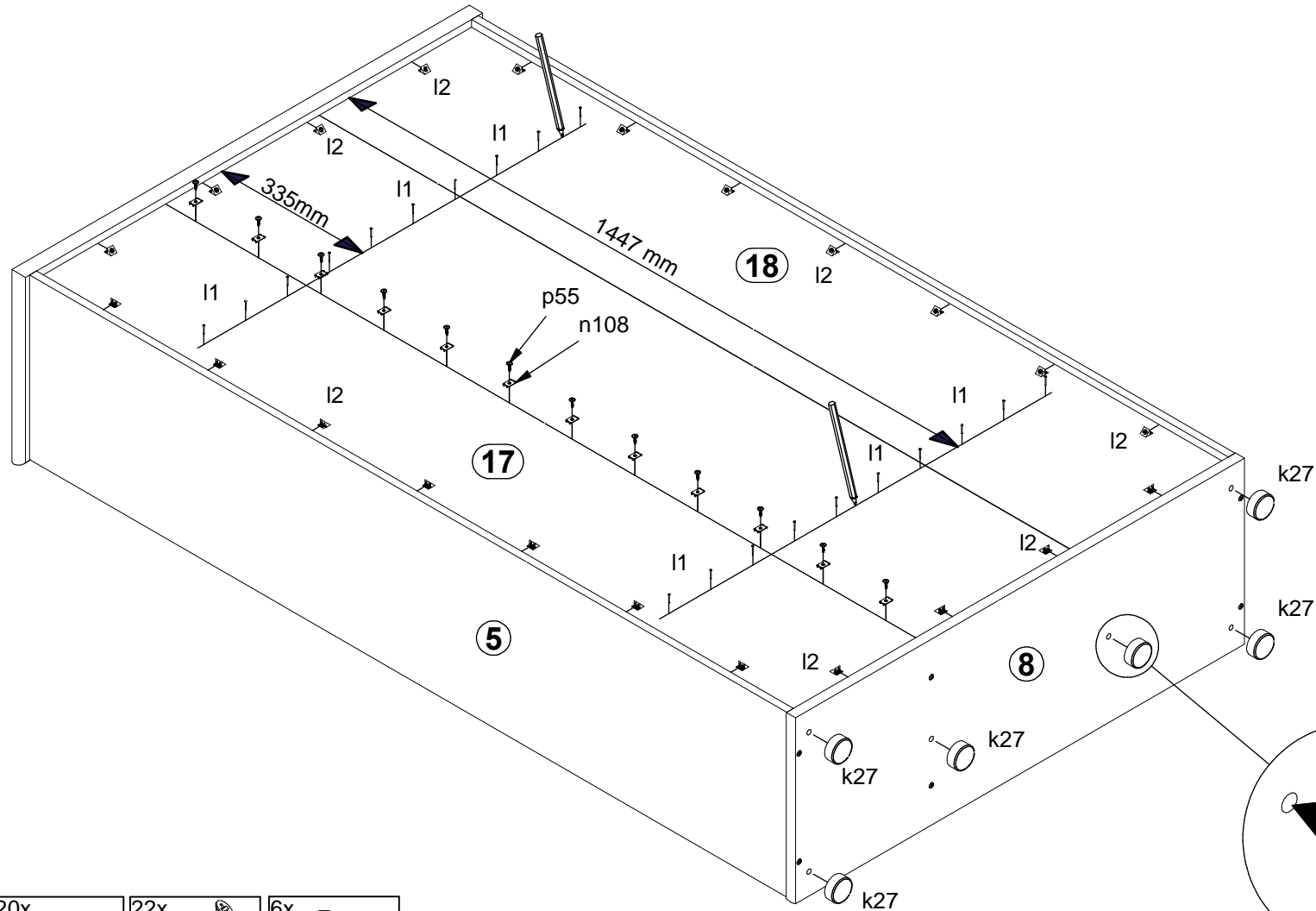
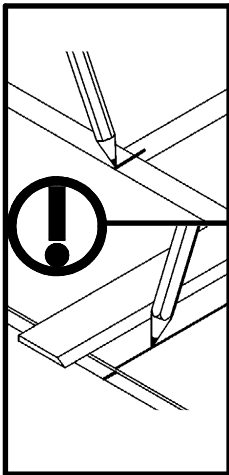
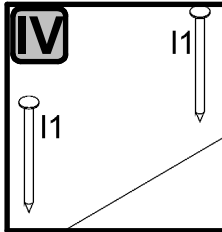
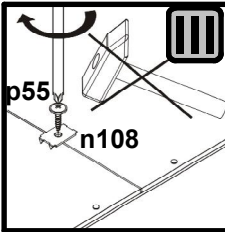
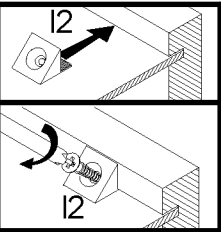
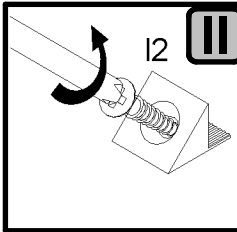
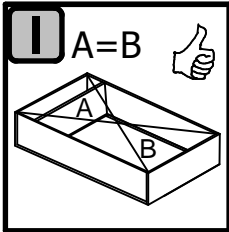

7

I

II

III

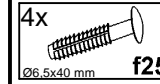
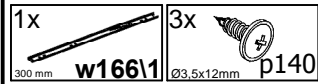
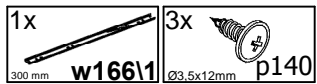
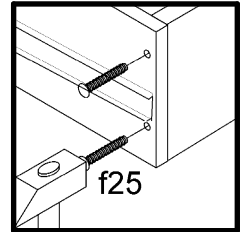
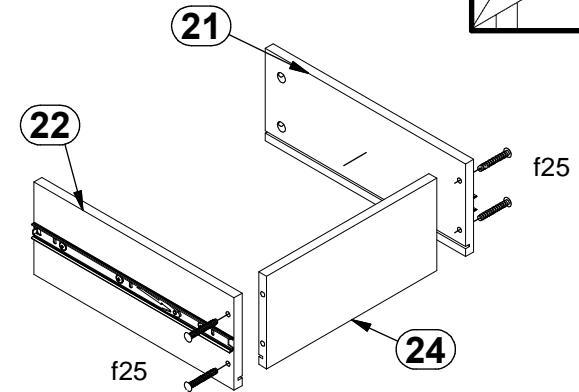
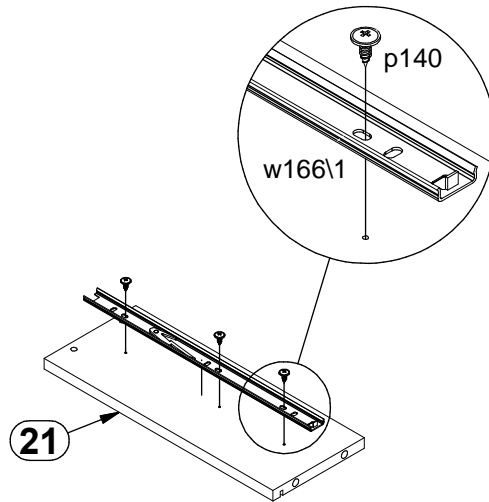
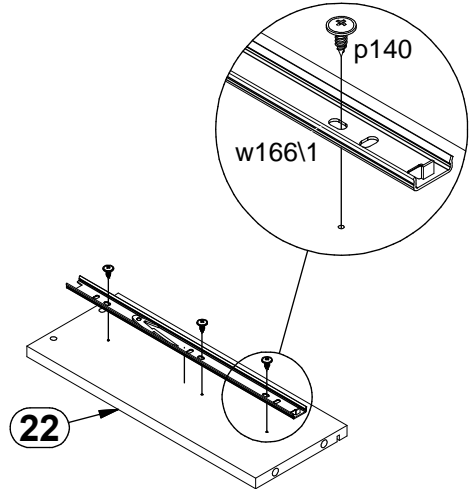

IV

V

VI

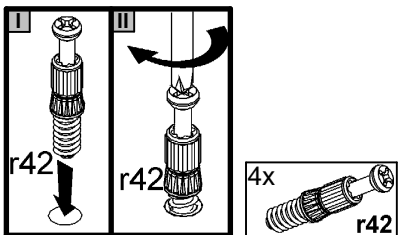
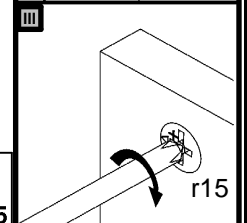
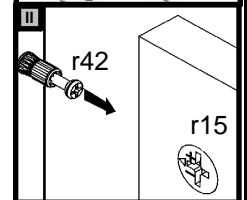
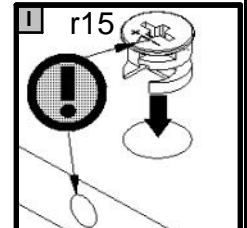
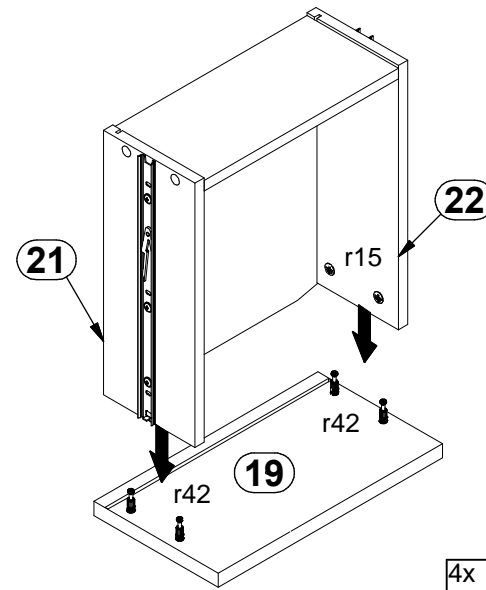
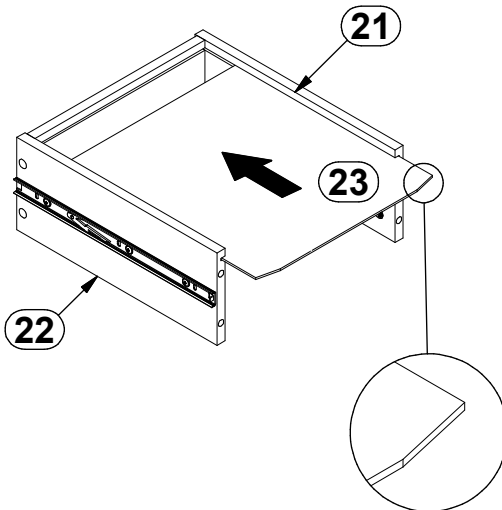
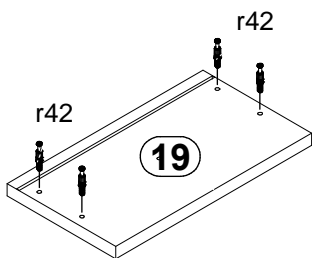

VII 7

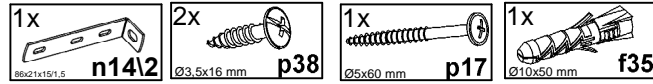
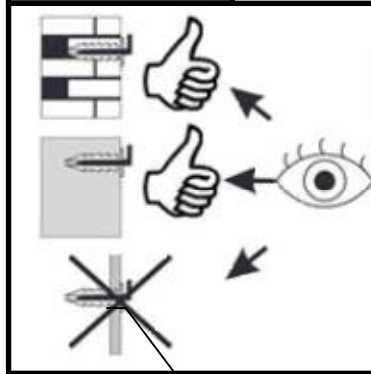
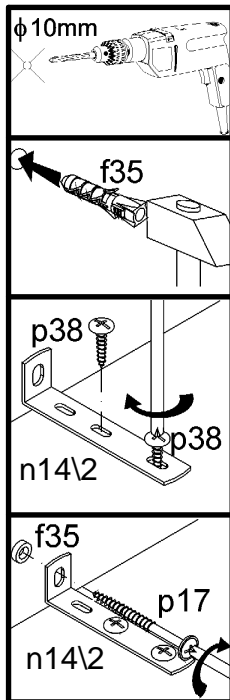
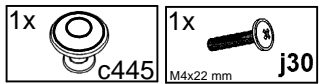
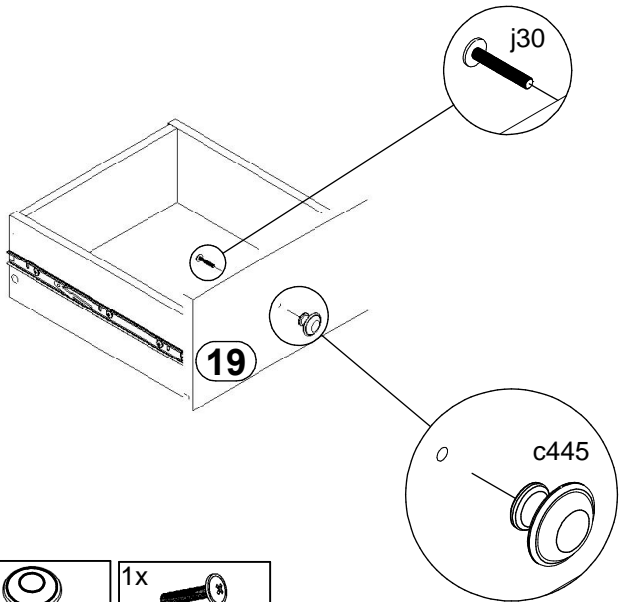
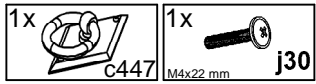
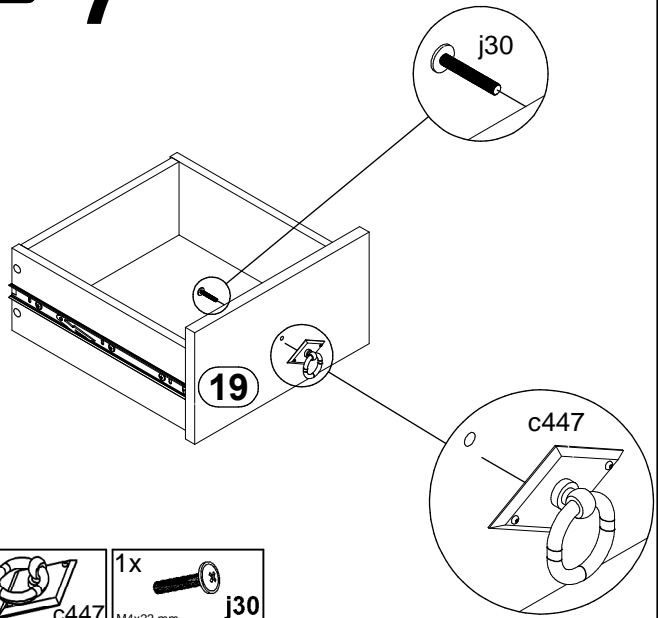

8

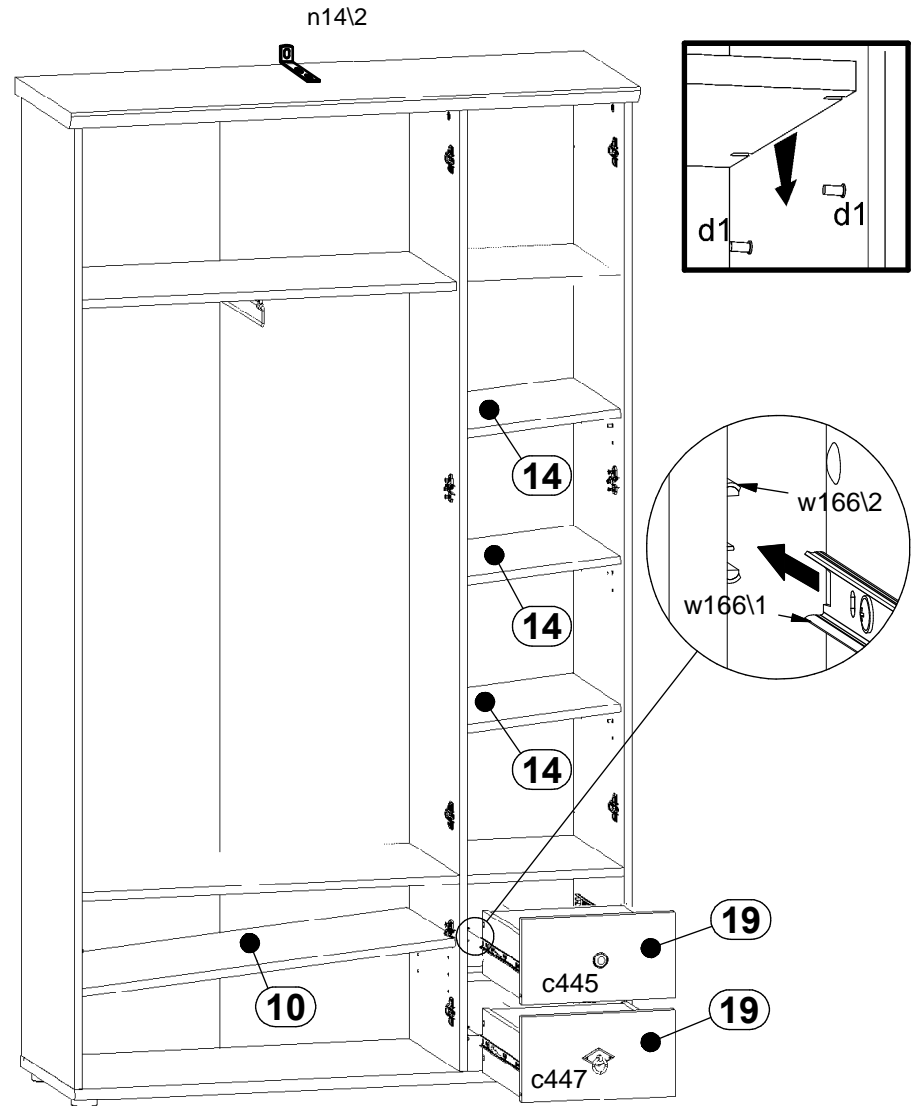

9

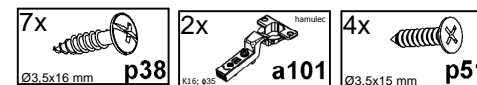
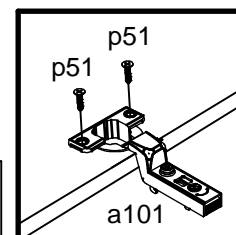
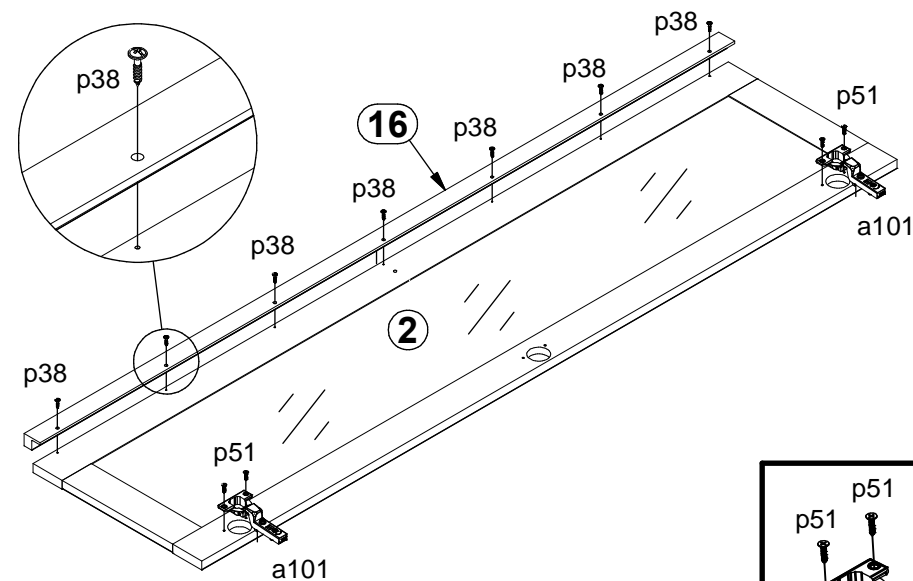
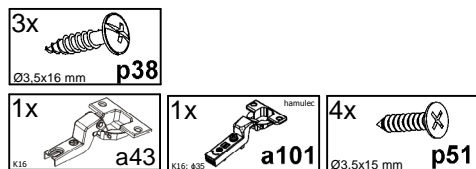
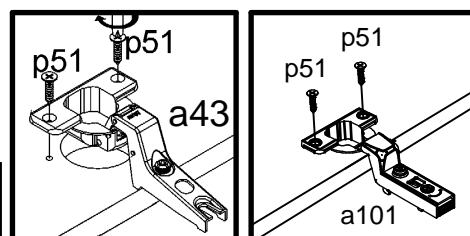
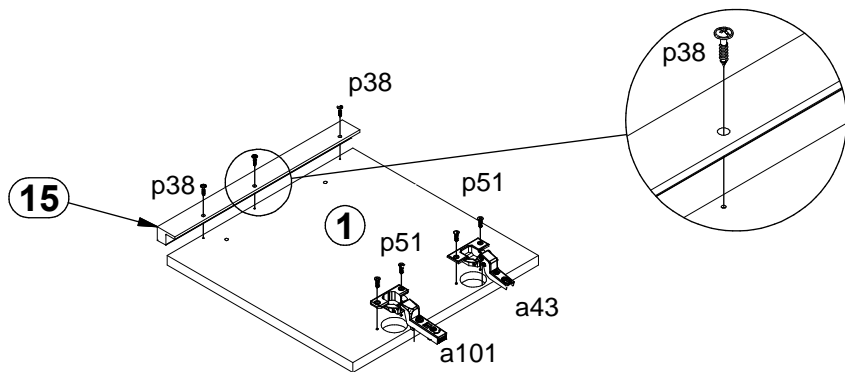
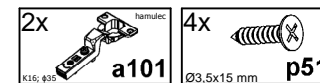
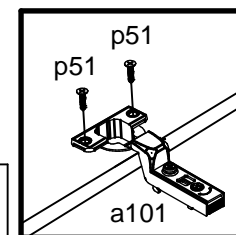
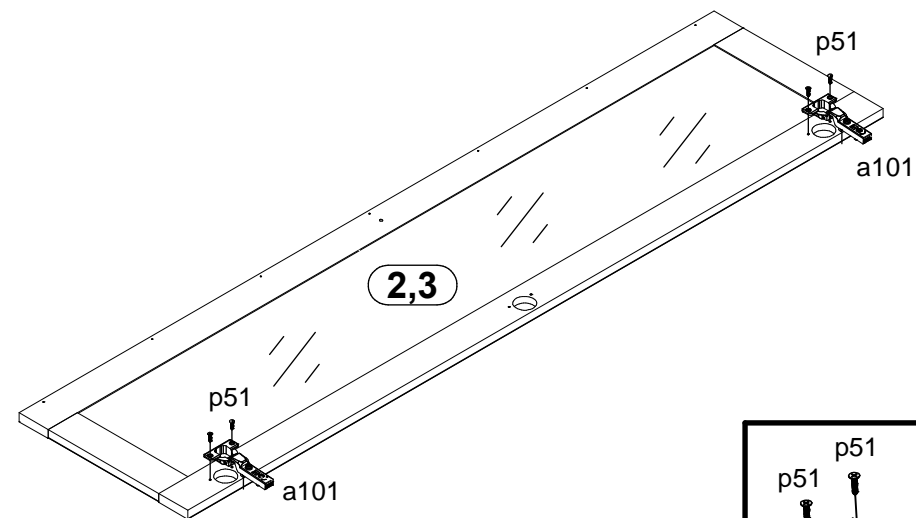
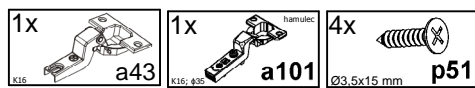
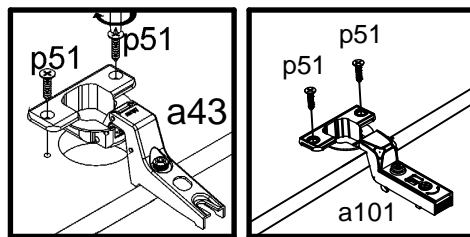
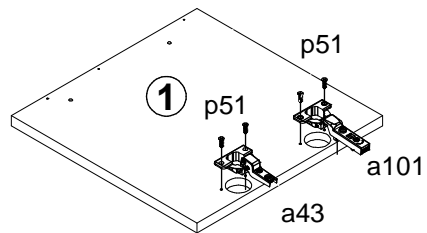

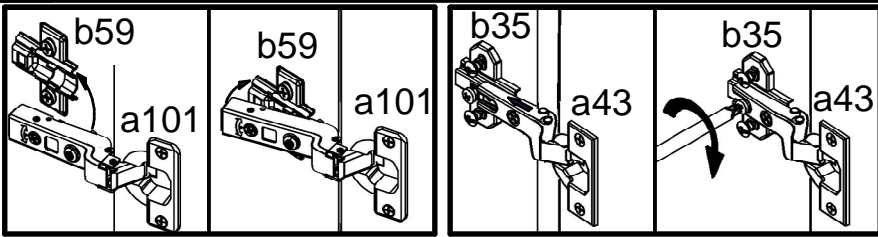

11

12

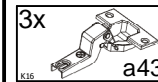
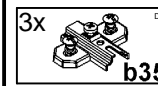
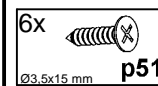
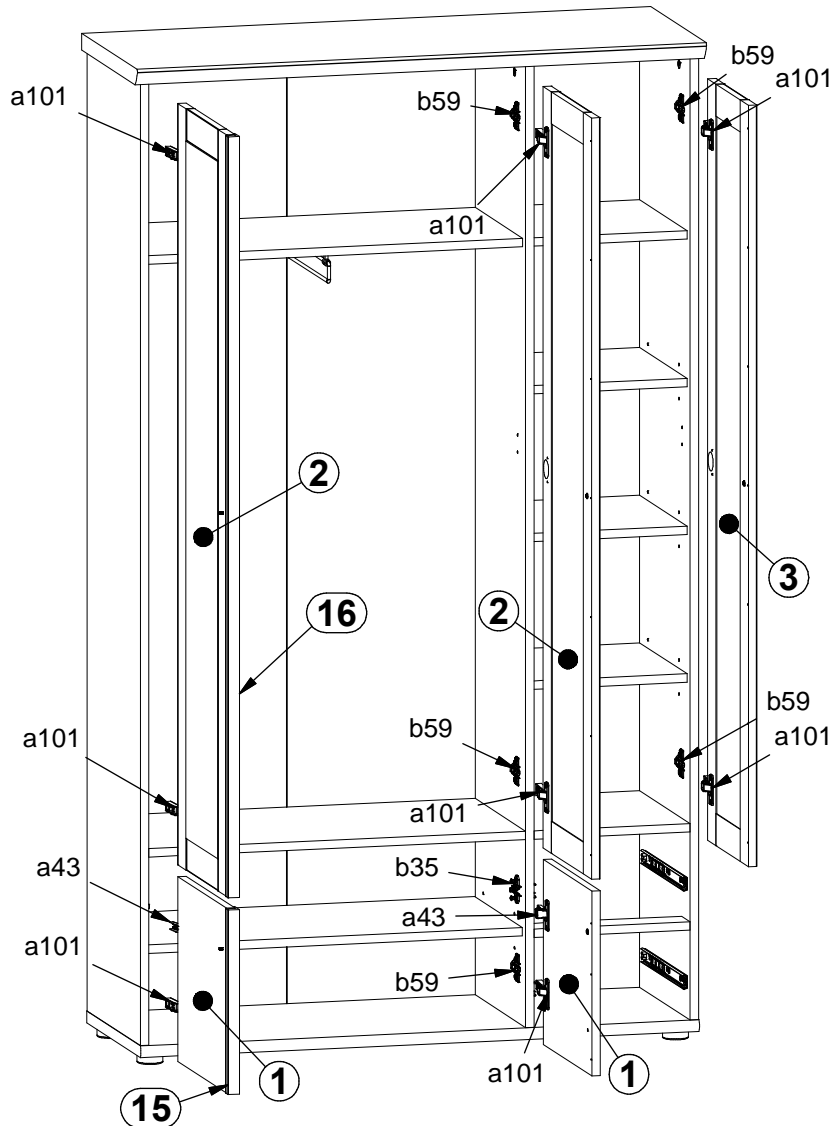
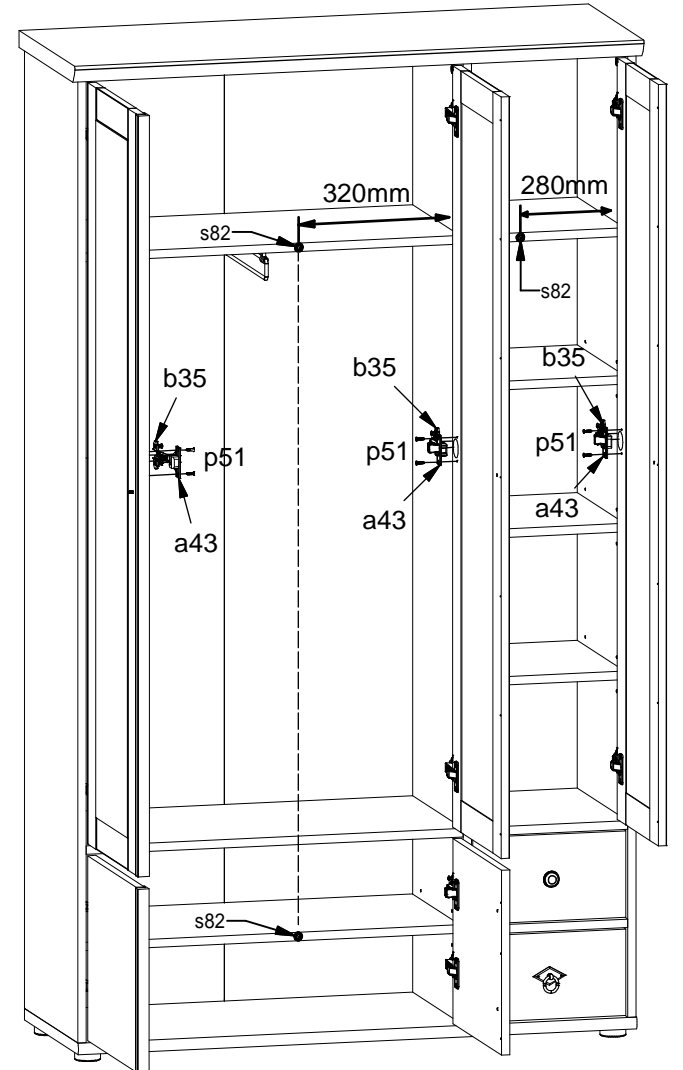
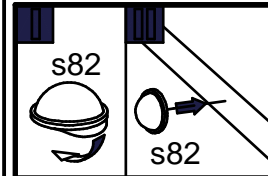
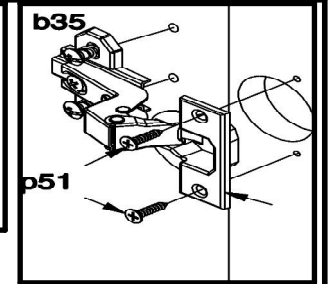
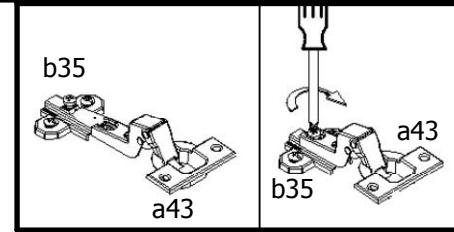

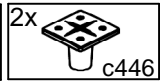
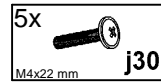
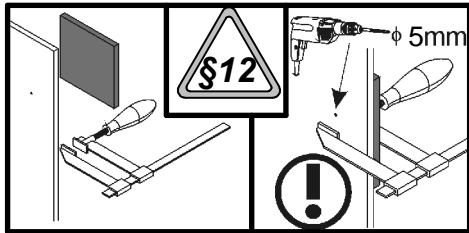

# 13

