

BELLANO 30G1_41

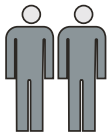

180 min

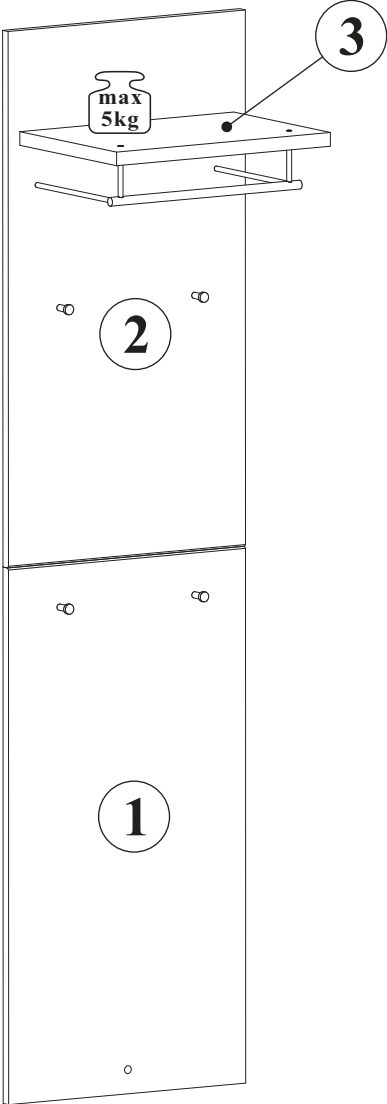

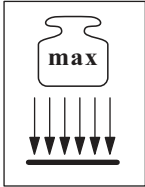
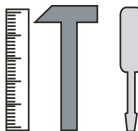

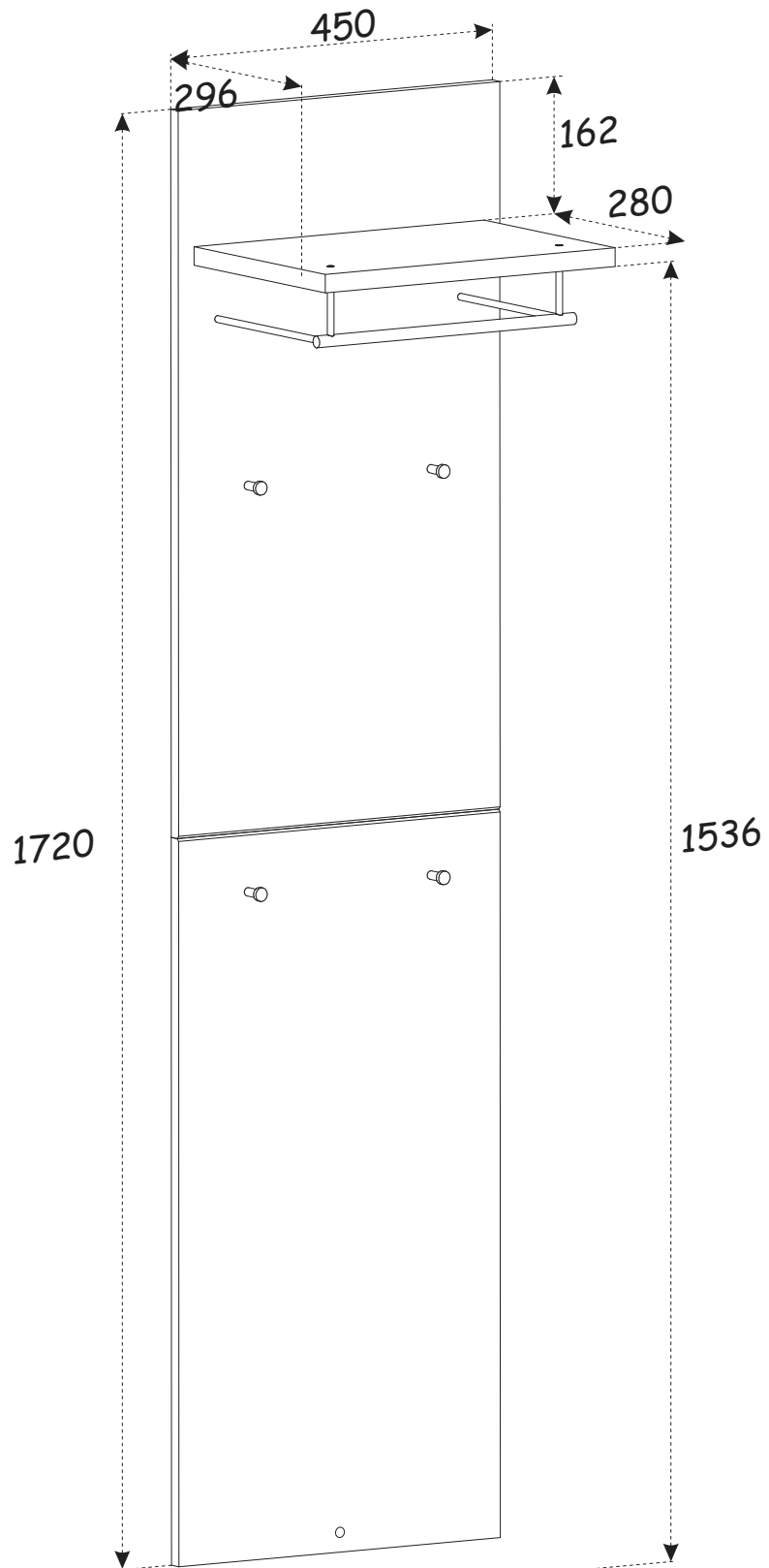

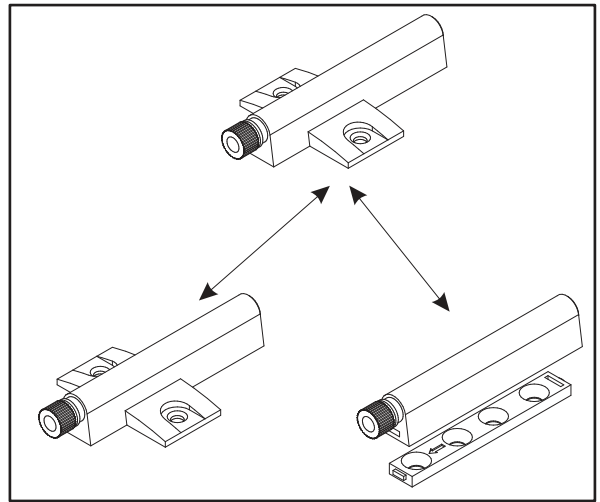
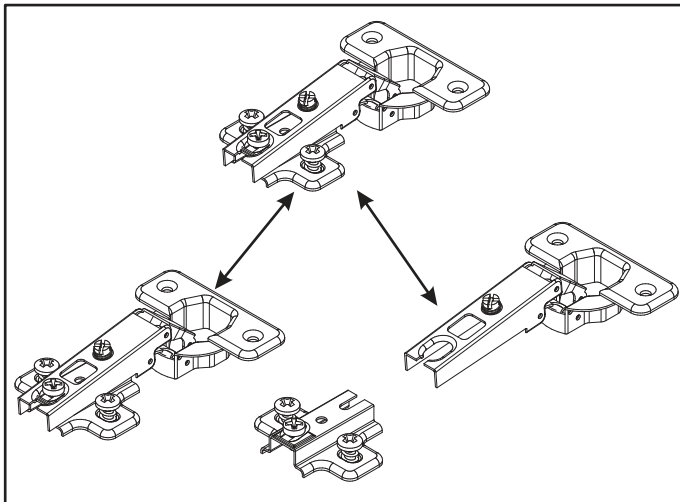
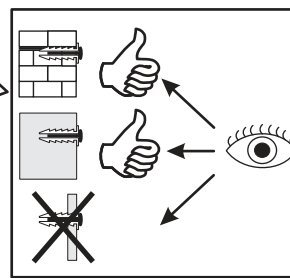
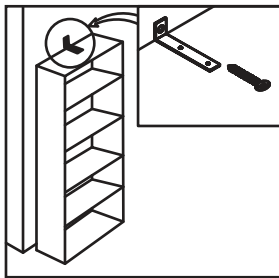
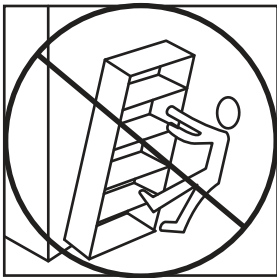
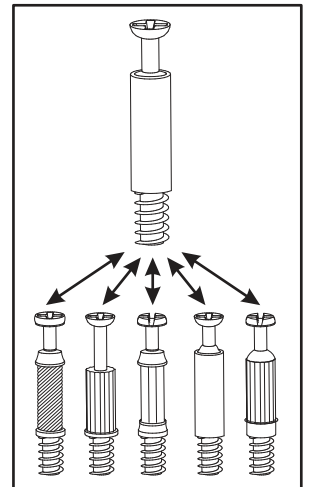
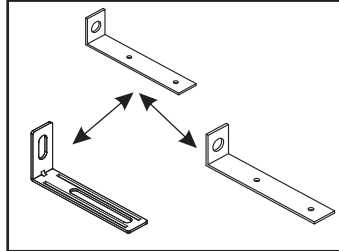
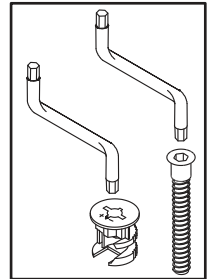
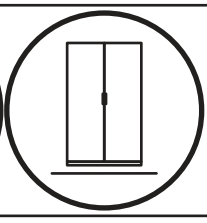
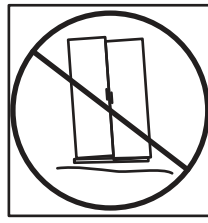
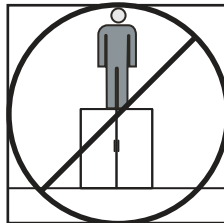
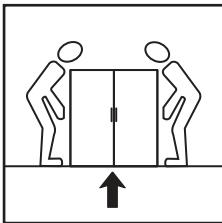
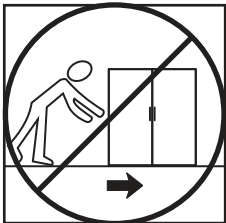
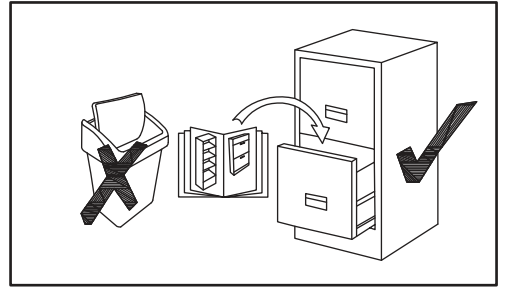
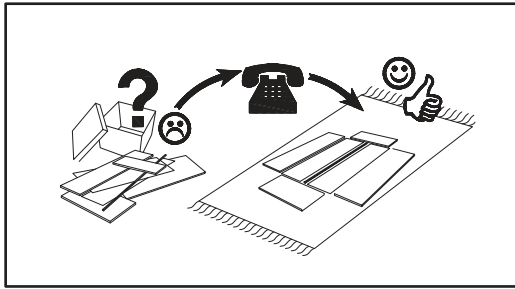
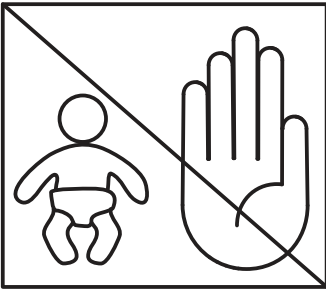
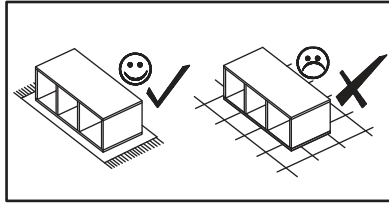
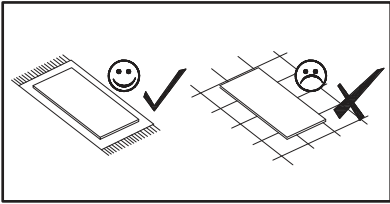



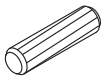
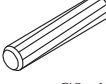
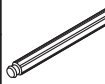
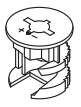

NO	Dim.[mm]			Col.-No	Qty
1	860	450	16	1/1	1
2	860	450	16	1/1	1
3	406	280	22	1/1	1

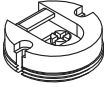

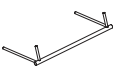

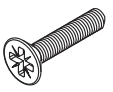
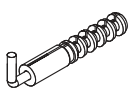
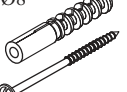

BELLANO 30G1__41

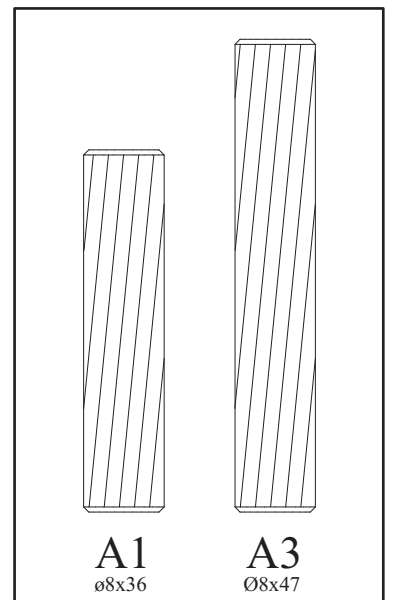
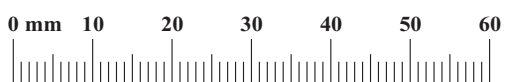
A1 x2  ø8x36	A3 x3  Ø8x47	B2 x2  Ø7x62	B5 x4  ø15x12	G5 x4 	B11 x3  Ø7x50
G4 x3 	ZM1 x3 	D20 x6  ESØ6x9,5	C18 x1  MA038.0360.P61 L-340	C17 x4  MG065.P61	DS6 x6  WSM4x25
WS3 x2  WSM4x30	KR3 x3  Ø10	KR4 x1  Ø8 UPØ5x70	G12 x1  Ø14	G2 x1 	



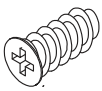
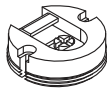

1

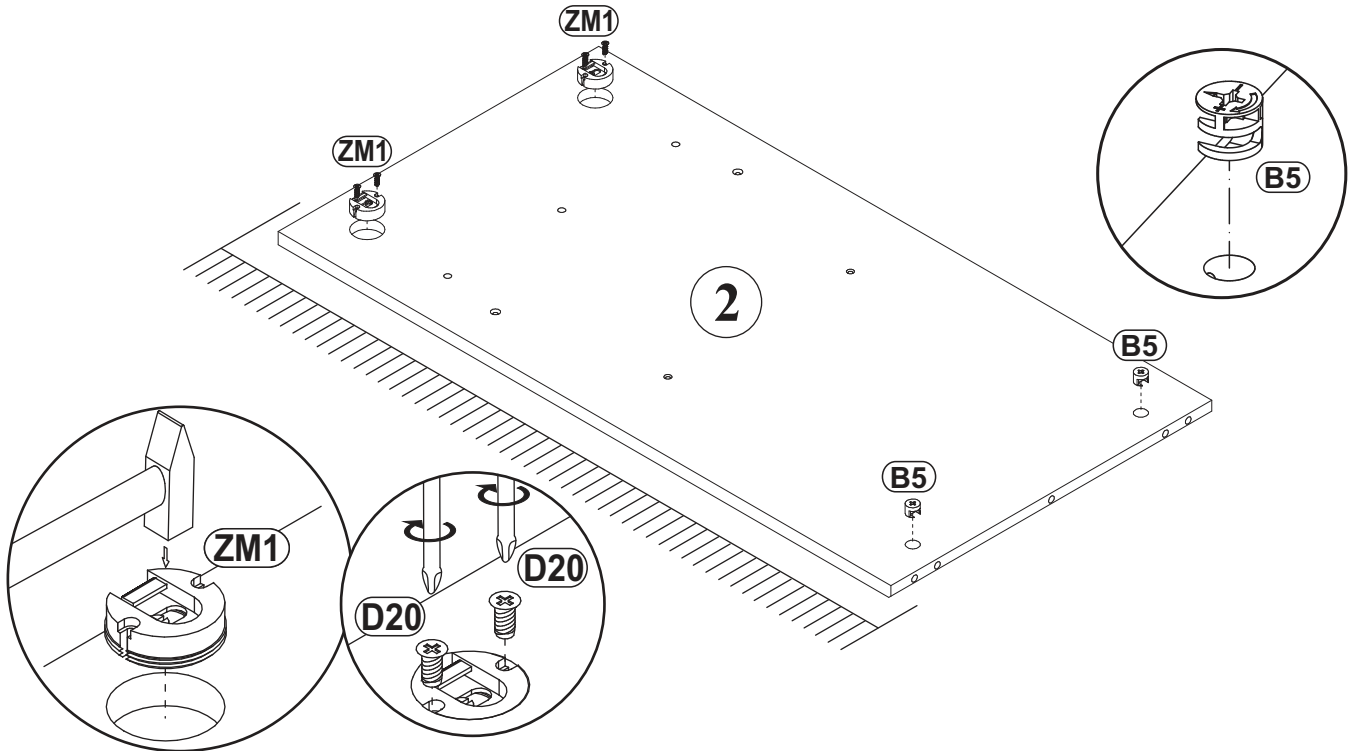
D20		ZM1		B5	
x4	ESØ6x9,5	x2		x2	ø15x12

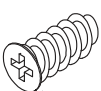
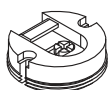

2

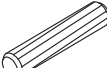
D20		ZM1		B5		A3	
x2	ESØ6x9,5	x1		x2	ø15x12	x3	Ø8x47

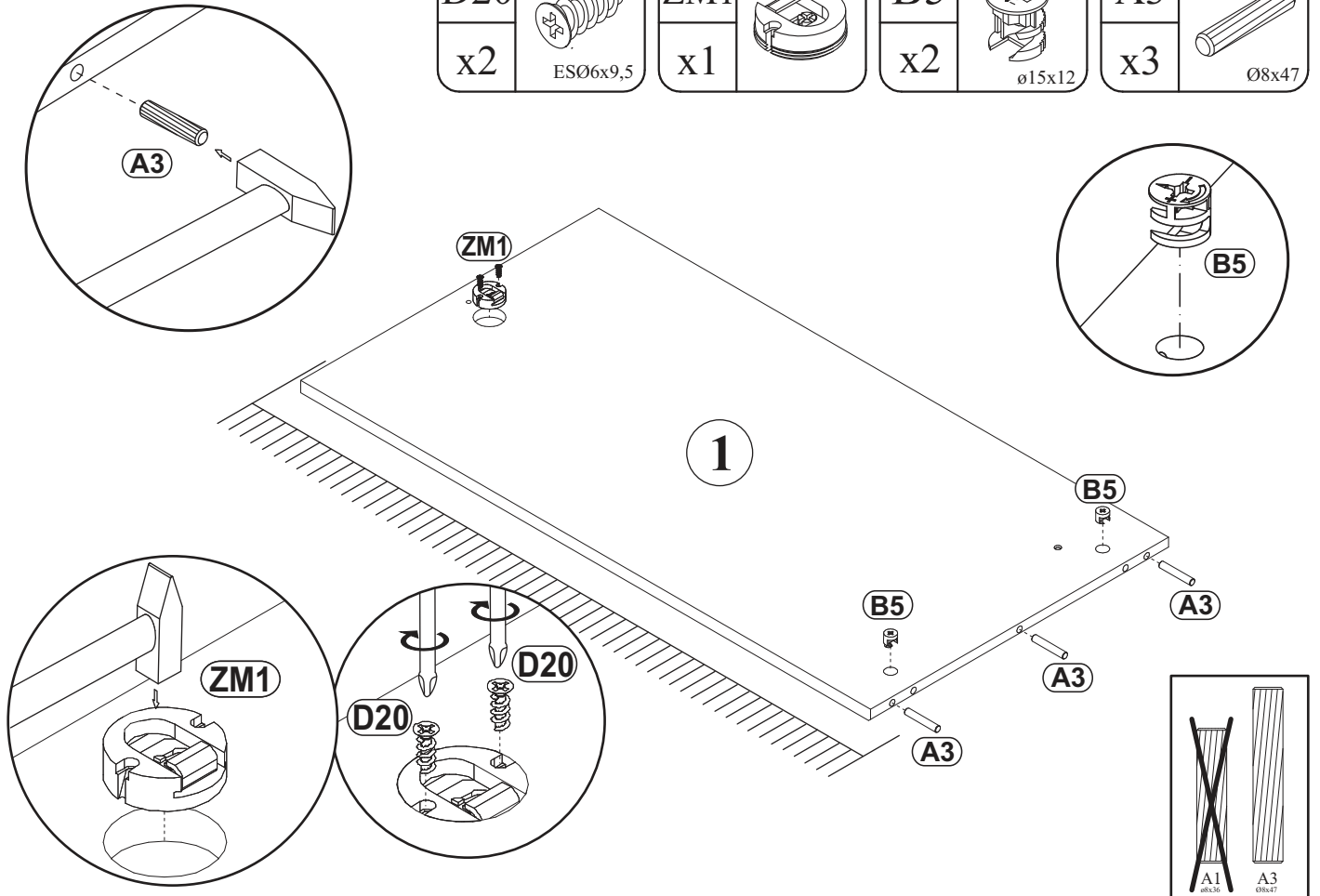

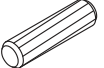
A1	
x2	ø8x36

3

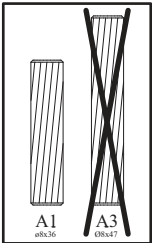
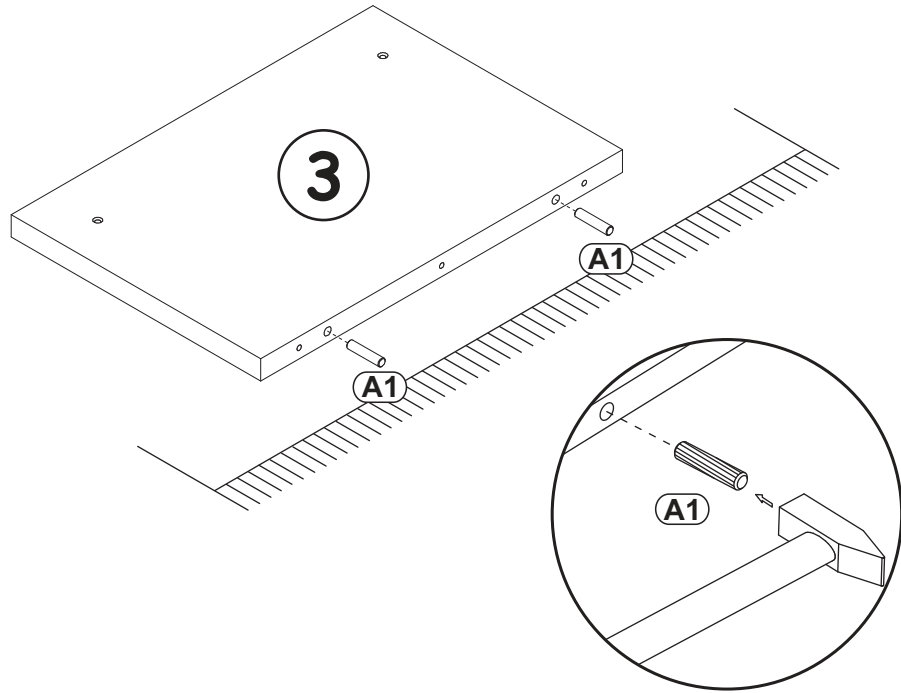

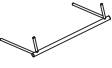

4

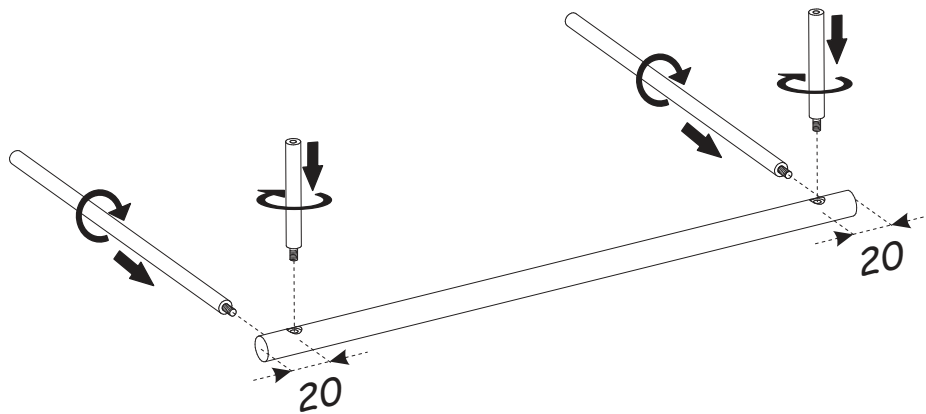
C18	MA038.0360.P61
x1	 L-340

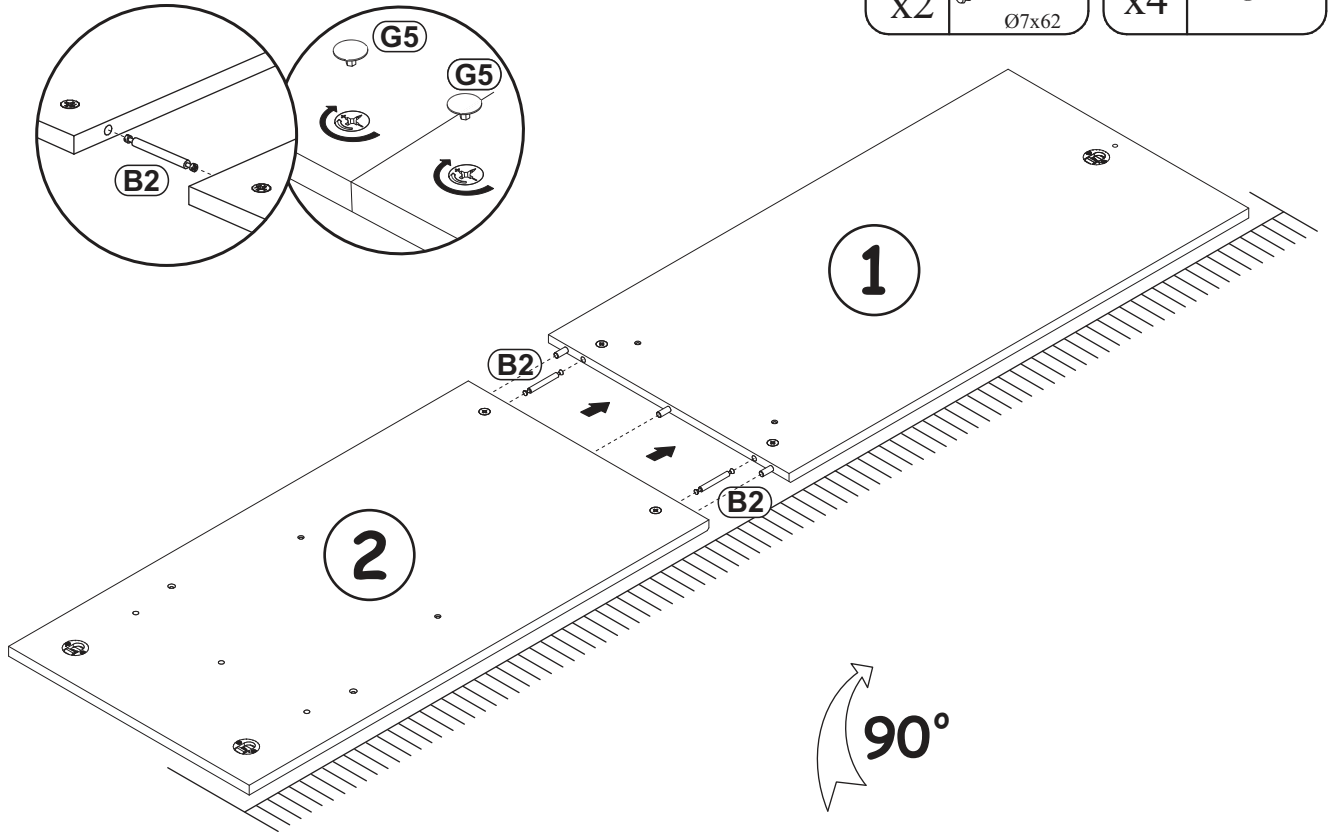

5





B2	
x2	Ø7x62

G5	
x4	

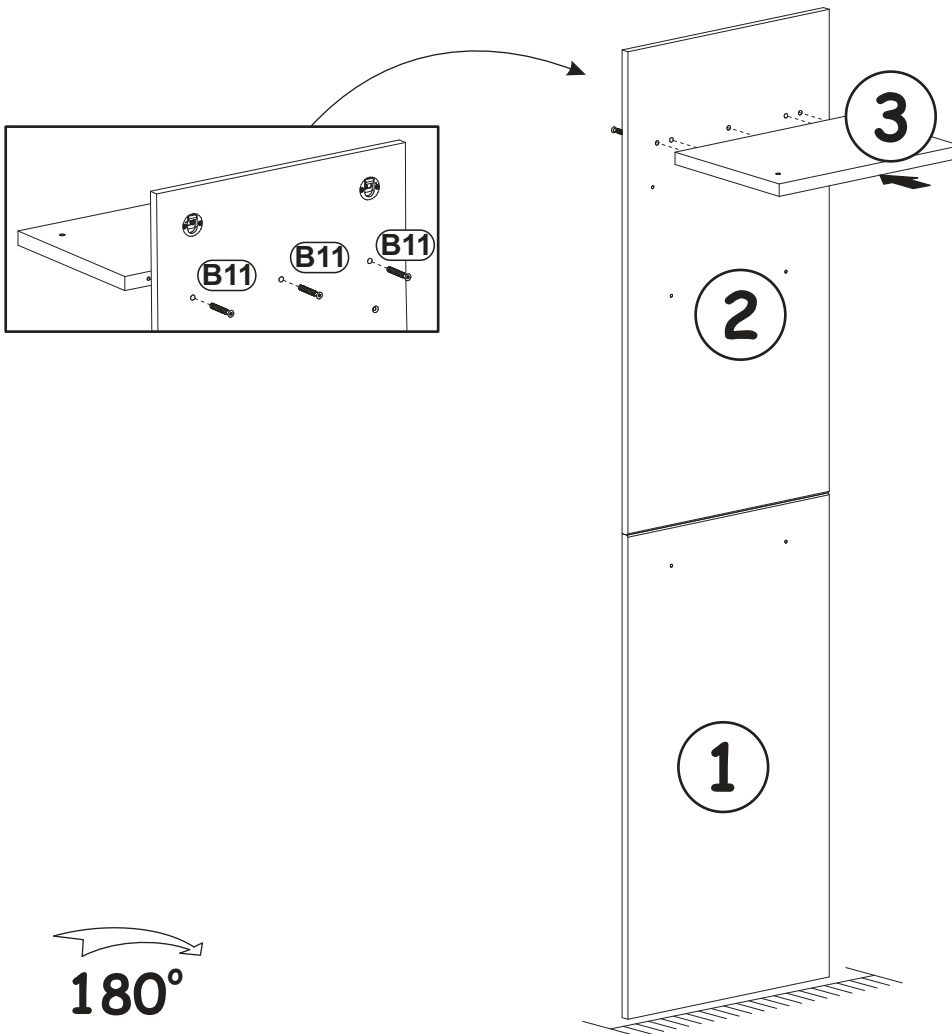
6



B11	
x3	Ø7x50

G4	
x3	

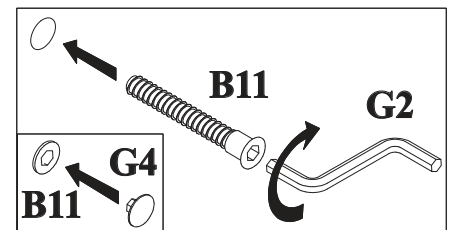

7

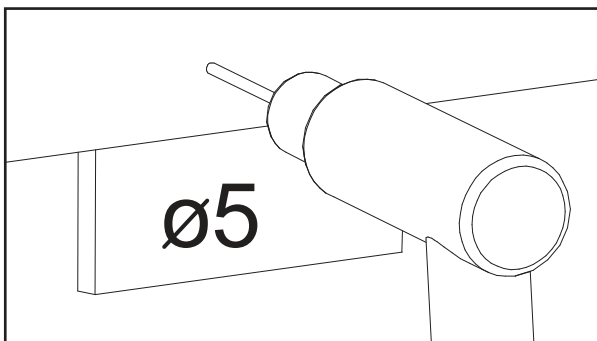
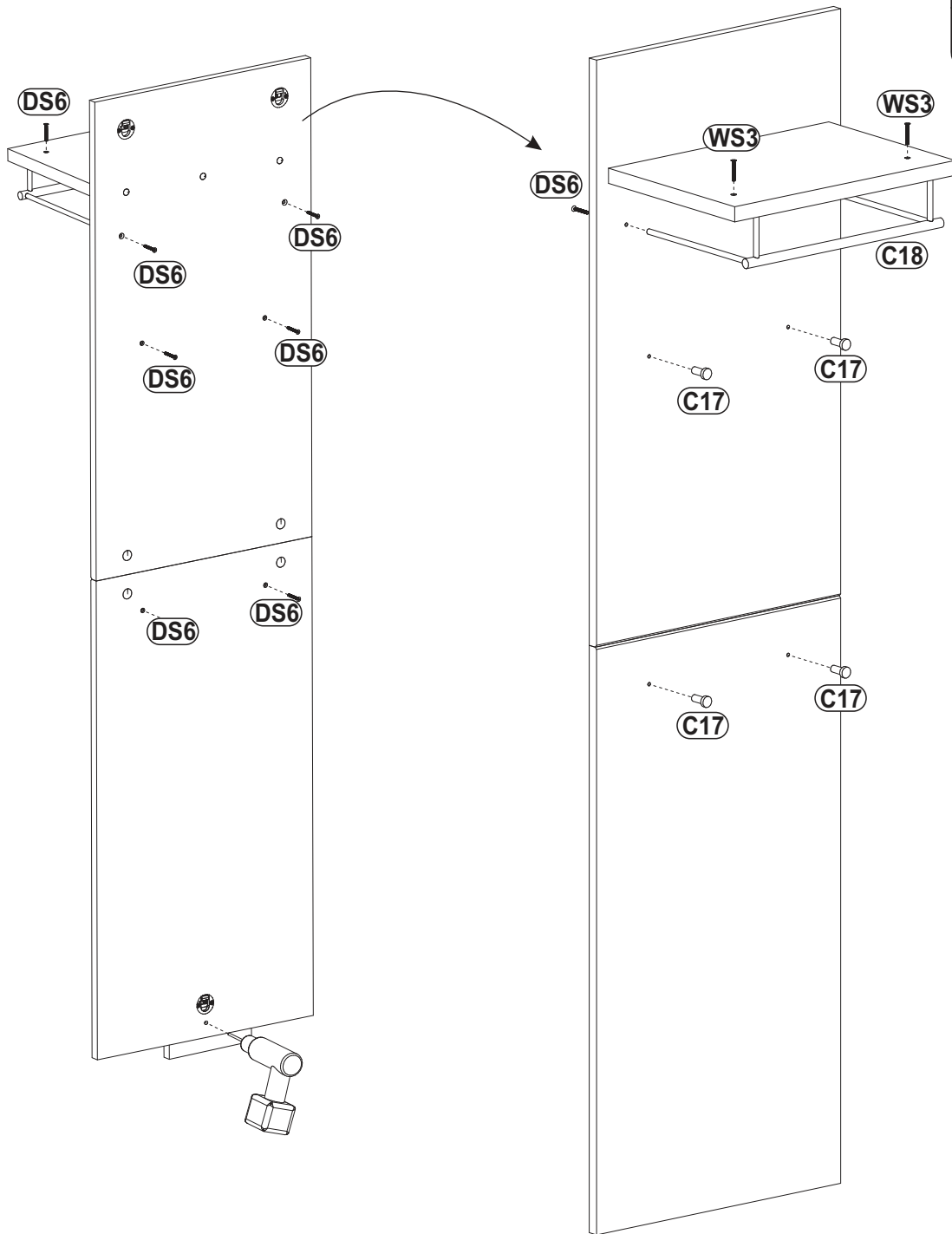
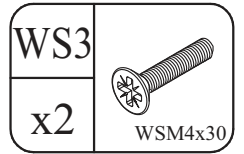
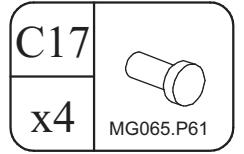
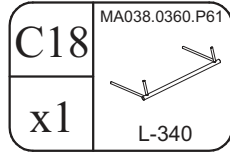
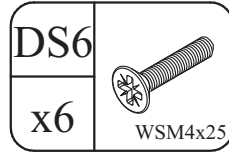

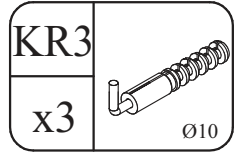

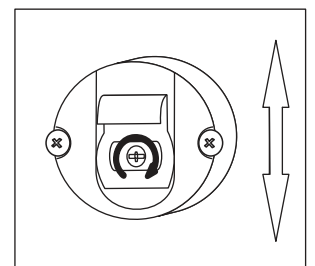
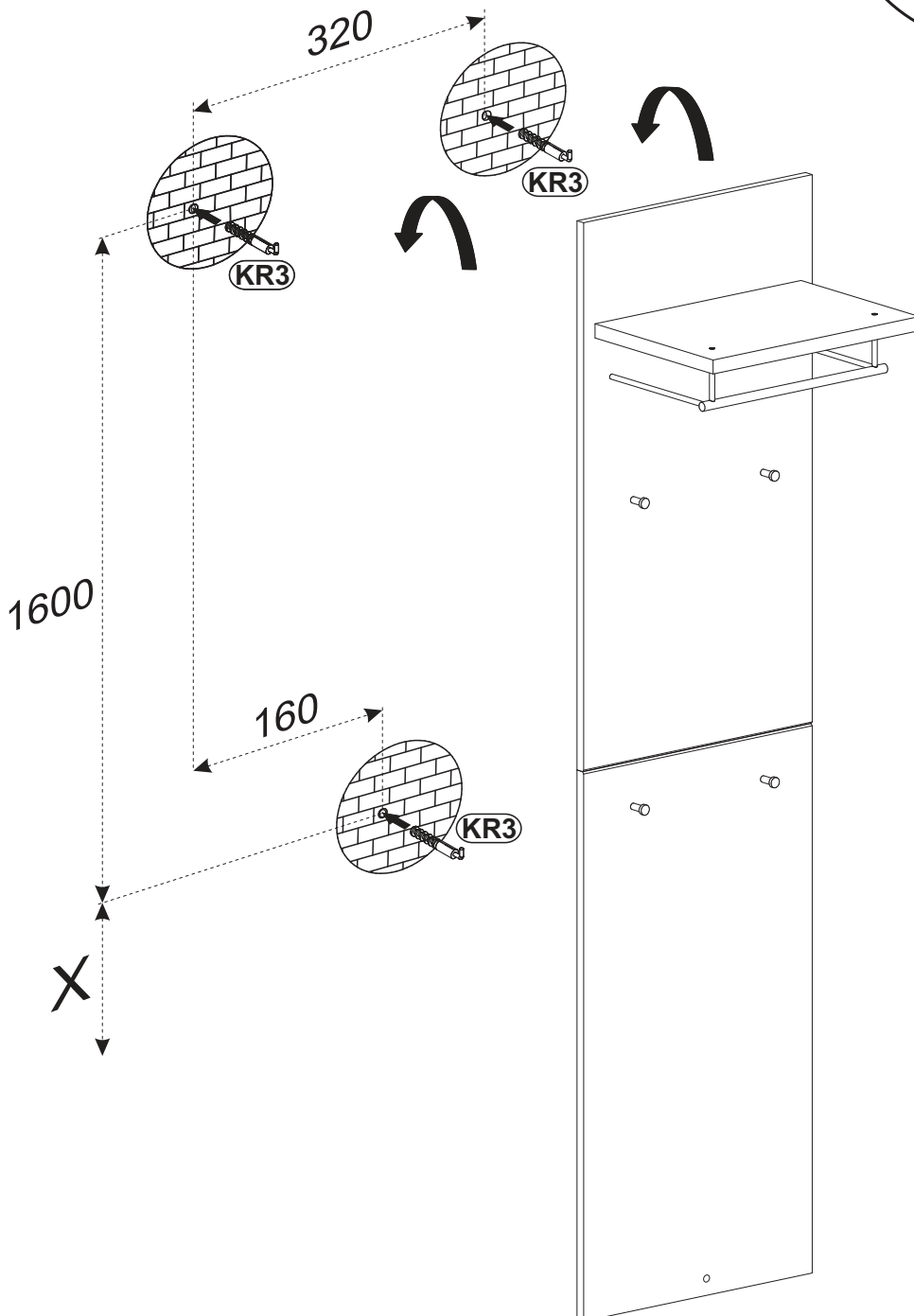
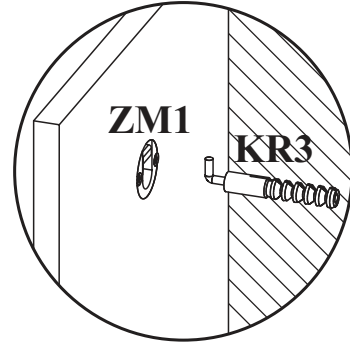
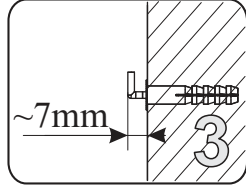
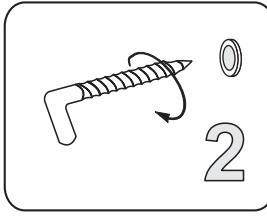
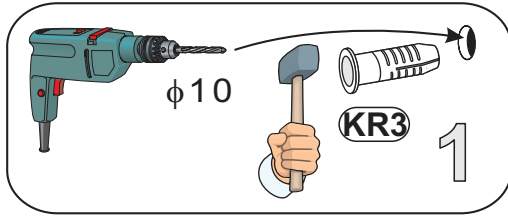

8

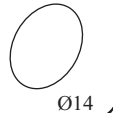

9

G12		KR4	
x1	Ø14	x1	Ø8 UPØ5x70

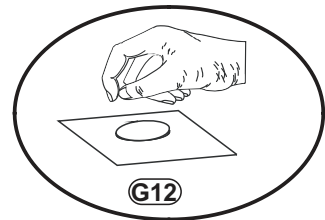
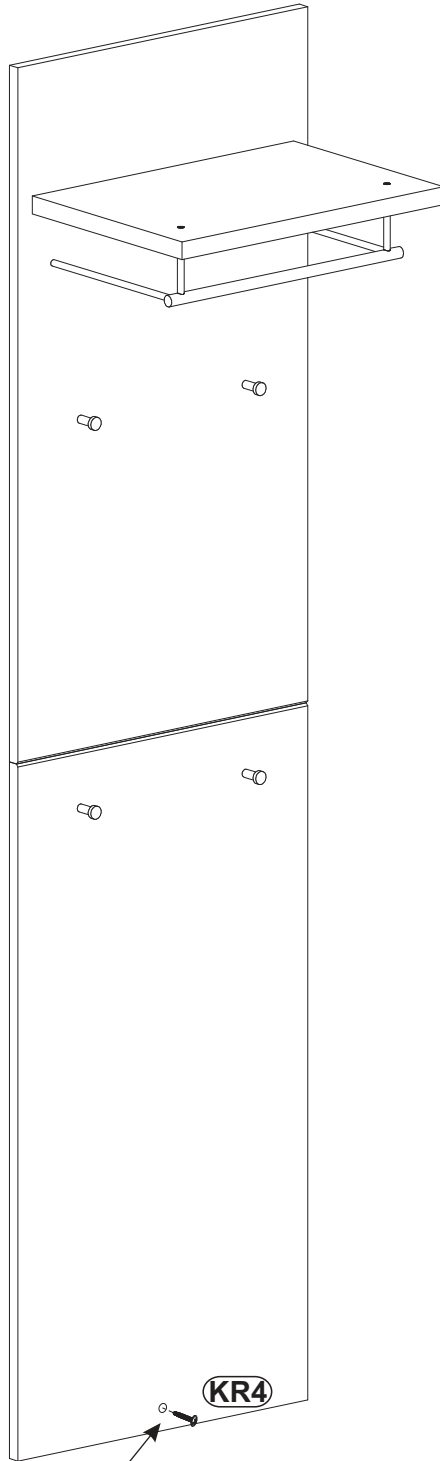

G12

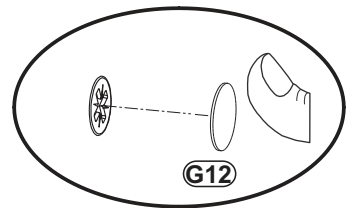

G12

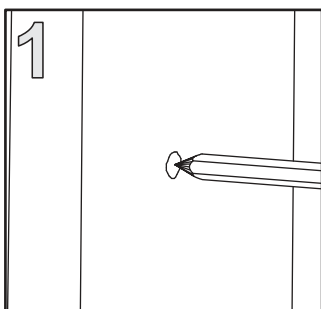
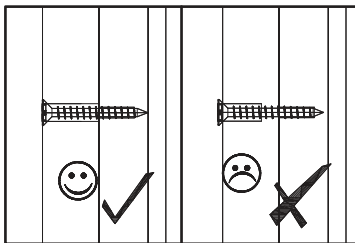

1

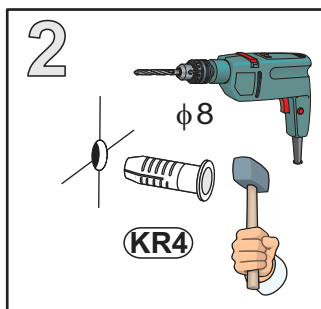

2

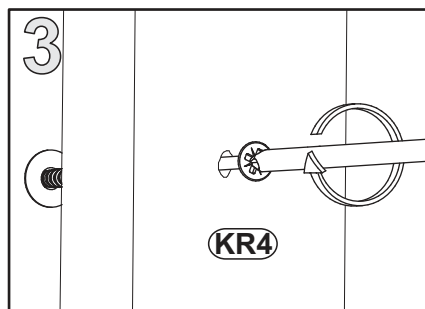

3